

SPECIAL FM NUMBER

RADIO CRAFT

HUGO GERNSBACK, Editor



MAJOR EDWIN H. ARMSTRONG
FATHER OF FM

JUNE
1948

30¢

CANADA 35¢

RADIO-ELECTRONICS IN ALL ITS PHASES



These "sound jurors" record their preferences as they listen over test circuits.

Trial by "Sound Jury"



The engineer in the foreground talks over the test circuits which the other engineer sets up on a "circuit simulator."

AFTER Bell Laboratories engineers have designed a new talking circuit, they measure its characteristics by oscilloscopes and meters.

But a talker and a listener are part of every telephone call, and to satisfy them is the primary Bell System aim.

So, before the circuit is put into

operation, a "sound jury" listens in. An actual performance test is set up with the trained ears of the jurors to supplement the meters.

As syllables, words, and sentences come in over the telephones, pencils are busy over score sheets, recording the judgment of the listeners on

behalf of you and millions of other telephone users.

Targets of the transmission engineer are: your easy understanding of the talker, the naturalness of his voice, and your all-around satisfaction. To score high is one of the feats of Bell System engineering.

BELL TELEPHONE LABORATORIES

Exploring and inventing, devising and perfecting for continued improvements and economies in telephone service



YOU BUILD THIS Radio Circuit early in Course with Soldering Equipment and Radio Parts I send; practice mounting, connecting, soldering Radio parts.



YOU PRACTICE Radio Servicing with this Tester built from parts I send. Also use it to help earn **EXTRA MONEY** fixing neighbors' Radios.

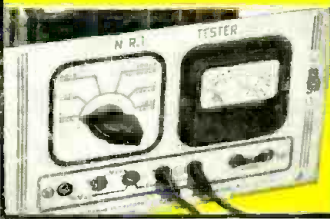

YOU PRACTICE "FM" Servicing on this Frequency Modulation (FM) Signal Generator, built with parts I supply; learn by repairing circuit defects.

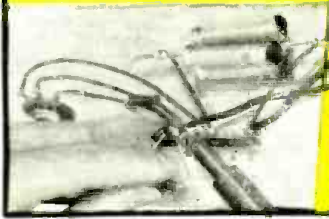

YOU BUILD THIS Vacuum Tube Power Pack, make changes which give you experience, learn how to locate and correct power pack troubles.

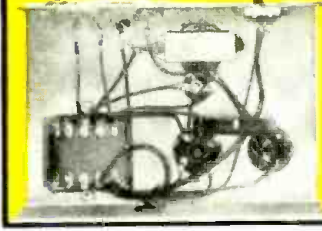

YOU BUILD THIS A. M. Signal Generator which provides amplitude-modulated signals for many tests and experiments, gives you practical experience.



YOU PRACTICE signal tracing on this complete Superheterodyne Circuit you build with parts I send you, use it to conduct many tests and experiments.



You Get **PRACTICAL EXPERIENCE** With This Superheterodyne Receiver

YOU BUILD THIS complete, powerful Radio Receiver that brings in local and distant stations. N. R. I. gives you **ALL** the Radio parts . . . speaker, tubes, chassis, transformer, sockets, loop antenna, etc.

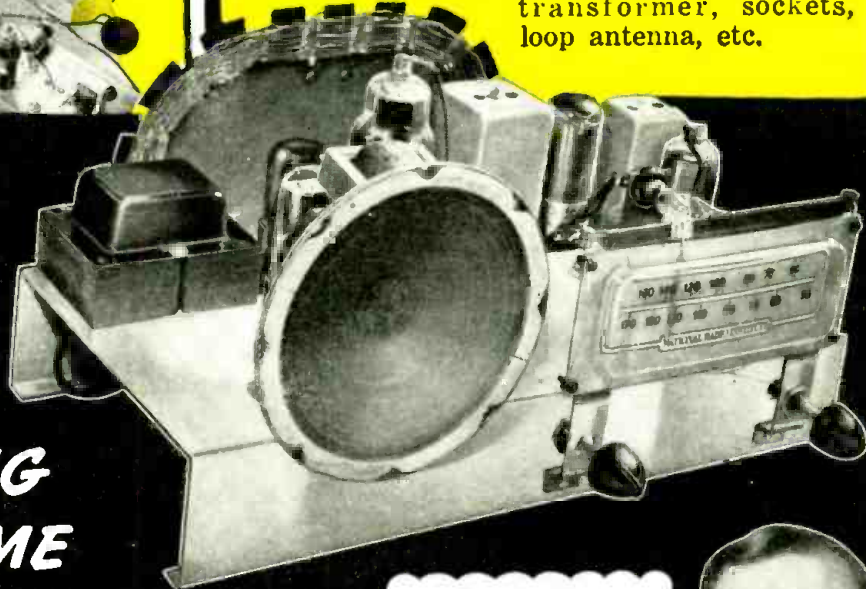

LEARN RADIO

BY PRACTICING IN SPARE TIME

WITH BIG KITS OF PARTS I SEND YOU

Do you want a good-pay job in the fast-growing Radio Industry—or your own Radio Shop? Mail the Coupon for a Sample Lesson and my 64-page book, "How to Be a Success in Radio-Television-Electronics," both **FREE**. See how I will train you at home—how you get practical Radio experience building, testing Radio circuits with **BIG KITS OF PARTS I SEND!**

Many Beginners Soon Make EXTRA Money in Spare Time While Learning

The day you enroll I start sending **EXTRA MONEY** manuals that show how to make **EXTRA** money fixing neighbors' Radios in spare time while still learning! It's probably easier to get started now than ever before because the Radio Repair

Business is booming. Trained Radio Technicians also find profitable opportunities in Police, Aviation, Marine Radio, Broadcasting, Radio Manufacturing, Public Address work. Think of even *greater* opportunities as public demand for Television, FM and Electronic devices continues to grow! Send for **FREE** books now!

Find Out What NRI Can Do For You

Mail Coupon for Sample Lesson and my **FREE** 64-page book. Read the details about my Course, letters from men I trained; see how quickly, easily you can get started. No obligation! Just **MAIL COUPON NOW** in envelope or paste on a penny postal. J. E. SMITH, President, Dept. 8FX, National Radio Institute, Pioneer Home Study Radio School, Washington 9, D. C.

I WILL TRAIN YOU AT HOME

MY COURSE INCLUDES FREQUENCY MODULATION, TELEVISION, ELECTRONICS



I TRAINED THESE MEN

Has Own Radio Service

"I have my own Radio and Television sales and servicing business. I get enough repair jobs to keep me going right along."—ALEXANDER KISH, 34 Pershing Avenue, Carteret, New Jersey.

Good Spare Time Business

"I have been getting receivers to repair right along, and with N. R. I. methods I don't have to spend much time on them."—S. N. STRICKLAND, 191 Dale Homes, Portsmouth, Virginia.

GET BOTH 64 PAGE BOOK **FREE** SAMPLE LESSON

MR. J. E. SMITH, Pres., Dept. 8FX, National Radio Institute, Washington 9, D. C.

Mail me **FREE** Sample Lesson and 64-page book about how to win success in Radio and Television—Electronics. (No salesman will call. Please write plainly.)

Name _____ Age _____
 Address _____
 City _____ Zone _____ State _____
 Check if Veteran

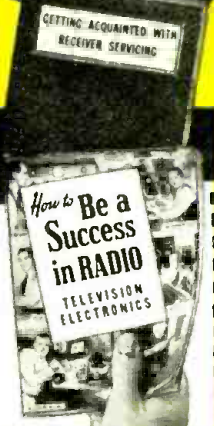

VETERANS

You get this training in your own home under G. I. Bill. Mail Coupon.

APPROVED FOR TRAINING UNDER GI BILL

Capitol Radio Engineering Institute—Pioneer in Radio Engineering Instruction Since 1927

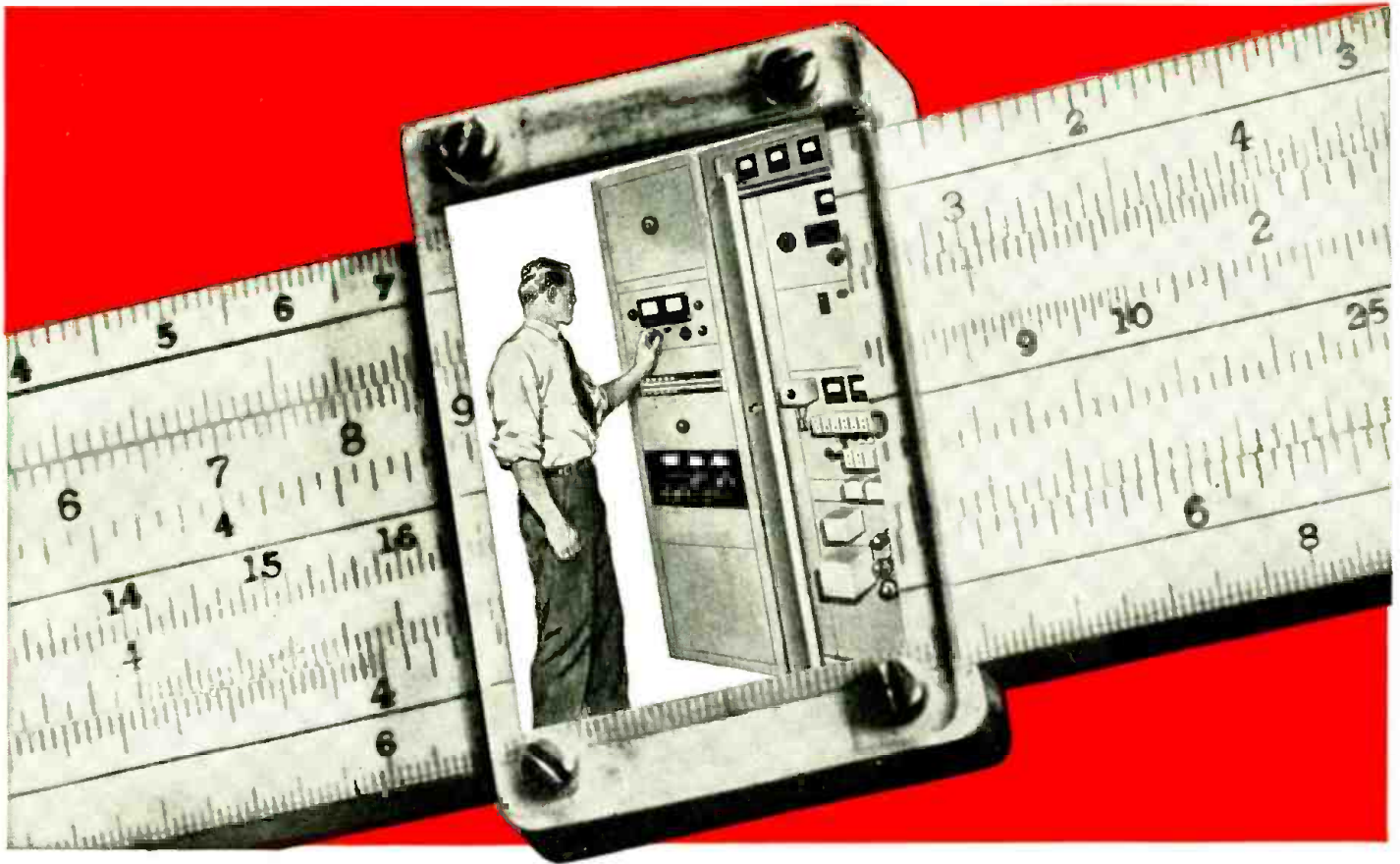

Here's how you can figure on a **BETTER JOB** in RADIO-ELECTRONICS, Broadcasting, Television, Servicing, Manufacturing

Add CREI Technical Training to Your Present Radio Experience. Then Get That Better Radio Job—Make More Money—Enjoy Increased Security.

You can't plan your future on a slide rule. But you *can* take a measurement of your own capabilities.

Look at the successful radioman. You'll find that he's the fellow who looked and *planned* ahead. Today, you have the same opportunity—at a time when radio's *technical* progress has gone beyond the supply of technical Manpower. Never before have so many men like you had the opportunity to step ahead into better-paying jobs . . . jobs that offer real interest and security in any one of the many expanding fields that urgently need competently trained men.

You can't say, "*I don't need more training.*" Every ambitious radio technician needs more training. No matter what your experi-

If you have had professional or amateur radio experience and want to make more money, let us prove to you we have the training you need to qualify for a better radio job. To help us answer intelligently your inquiry—*please state briefly your background of experience, education and present position.*

Capitol Radio Engineering Institute

An Accredited Technical Institute

Dept. RC-6, 16th and Park Road, N. W., Washington 10, D. C.
Branch Offices: New York (7) 170 Broadway • San Francisco (2) 760 Market St.

ence, you must fortify yourself with up-to-date technical knowledge to qualify for the better jobs and to stave off the new competition that war-time activity has brought into the field.

CREI has a course of training for *you*. You will find our proved type of training practical and thorough. Whether your future lies in broadcasting, television, servicing, manufacturing or any branch of communications, you will find that you can "*go all the way with CREI*" from introductory, basic principles to advanced training, and on to specialized fields of radio-electronics.

Send for, and read, our interesting 24-page booklet. It explains our self-improvement program, courses and what CREI can do for you. It will give you a good idea how practical and easy-to-understand our training is, and why many thousands have enrolled for CREI courses since 1927.

VETERANS! CREI TRAINING AVAILABLE UNDER G. I. BILL

MAIL COUPON FOR FREE BOOKLET

CAPITOL RADIO ENGINEERING INSTITUTE
16th & Park Road, N. W., Dept. RC-6, Washington 10, D. C.

Gentlemen: Please send your free booklet, "CREI training for your better job in Radio-Electronics," together with full details of your home-study training. I am attaching a brief resume of my experience, education and present position.

Check field of greatest interest:

- PRACTICAL RADIO-ELECTRONICS PRACTICAL TELEVISION
 BROADCASTING AERONAUTICAL RADIO ENGINEERING
 RECEIVER SERVICING INDUSTRIAL ELECTRONICS

NAME _____

STREET _____

CITY _____ ZONE _____ STATE _____

I AM ENTITLED TO TRAINING UNDER G. I. BILL.

RADIO-CRAFT for

Make More Money in

Radio TELEVISION & ELECTRONICS

NOW!

Get these 2 BIG BOOKS

FREE!



If you are already employed in the great Radio industry, you know how great the demand is for trained, experienced servicemen, operators and technicians. You know how fast the field is growing and how important it is to keep up with new developments in F.M., Television and Electronics. The Radio industry is alive with opportunity for the qualified technician whose knowledge is up-to-the-minute. You can be an FM and Television specialist . . . get into the lucrative Radio Service Field . . . own a business of your own. If you prefer, National Schools of Los Angeles, for almost 50 years a practical resident and home study trade school, has put into effect its New 1948 Training Program. This program, adapted to National's Master Shop Method Home Study Course, can qualify you in your spare time as a Radio and Television technician. For details of this Program fill out and mail the coupon below.



You build this fine modern Superheterodyne Receiver and other units, with the complete standard parts we send you. This valuable equipment becomes yours to use and keep.

You learn by building equipment with standard radio parts we send you



NOW! New Professional Multitester Included!



This versatile testing instrument is portable and complete with test leads and batteries. Simple to operate, accurate and dependable. You will be able to quickly locate trouble and adjust the most delicate circuits. You can use the Multitester at home or on service calls. It is designed to measure AC and DC volts, current, resistance and decibels. You will be proud to own and use this valuable professional instrument.

SHOP METHOD HOME TRAINING from a Technical Trade Resident School

LEARN BY DOING

Work with Real Experimental Equipment Furnished without Extra Cost as Part of your National Schools Training



Send Coupon and prove to yourself what YOU can do in RADIO and TELEVISION!

National Schools brings its exclusive Shop Method of training right into your own home. You can learn the most up-to-date approved practical training projects, systems and modern circuits from the very beginning in your spare time. Here is sound and practical home training—the development of experienced instructors working with students right in the shops, NEW Television and Broadcast Studios and Experimental Laboratories of NATIONAL SCHOOLS—one of the most advanced technical trade education centers in the world.

Take Advantage Now of these Outstanding Features of National Schools' 1948 Training Program

1. National Schools' 1948 Course is planned to prepare you for real success in Radio Television and Electronics.
2. Experimental equipment supplied with the Course has been completely revised to give you the most up-to-date practical experience with new circuits, new units, etc. right in your own home.
3. New Television Lessons have been expanded to give you training in the latest developments in this important field.
4. The 1948 Course includes a Professional Multitester (shown above) for your use in spare or full-time Radio work.
5. National Schools gives you advanced training—the key to the better positions in Radio, Television, Electronics.
6. You are sent standard Experimental Equipment, including tubes and accessories, for building a modern Short Wave and Standard Broadcast Superheterodyne Receiver. All equipment becomes your personal property.
7. National Schools' nearly 50 years of experience in Technical Trade Training . . . our modern shops and laboratories . . . highly trained instructors are back of your time-tested Training Plans for a brighter future.

BOTH HOMESTUDY AND RESIDENT COURSES OFFERED

APPROVED FOR VETERANS

CHECK COUPON

EXPERIENCE IS THE BEST TEACHER. You learn by experience with the exclusive National Shop-Method of Home Training. With the apparatus sent you, you actually build various types of standard equipment—a powerful superheterodyne receiver, a signal generator, an audio oscillator, low power Radio transmitter and other units. You make tests and conduct experiments that show you the why and how of Radio. You understand what makes the various elements of Electronics operate because you actually see them work for you. Not only do you gain splendid experience by this method of learning, but you receive valuable equipment you will use on the job in the practice of your profession as a Radio Technician. Mail the coupon and learn what this means to you.

FREE LESSON INCLUDED

Examine the exclusive National Shop Method of Home Training. See for yourself how sound and practical it is. Be convinced that you can learn Radio, Electronics, Television—quickly and easily in your spare time. This trial is ABSOLUTELY FREE. Mail the coupon here for the books that tell you the complete story of National Schools' Master Shop Method of Home Training in Radio, Electronics and Television. This is the MODERN SYSTEM OF TRAINING: it matches the rapid progress constantly being made in Radio, Television and Electronics. It is TIME TESTED, too. National Schools has been training men for more than a third of a century. It is the very same training that has helped thousands to more pay and greater opportunity. You owe it to yourself—your future—to read the book "Your Future in Radio, Electronics and Television"—FREE to you when you send in the coupon.

NATIONAL SCHOOLS

LOS ANGELES 37, CALIFORNIA EST. 1905



MAIL OPPORTUNITY COUPON FOR QUICK ACTION

MEMBER: NATIONAL COUNCIL OF TECHNICAL SCHOOLS

NATIONAL SCHOOLS, Dept. RC-6

4000 South Figueroa Street, Los Angeles 37, California

MEMBER: NATIONAL HOME STUDY COUNCIL

(Mail in envelope or paste on penny post card)

Mail me FREE the two books mentioned in your ad, including a sample lesson of your course. I understand no salesman will call on me.

NAME AGE

ADDRESS

CITY ZONE CITY

Check here if Veteran of World War II

The Answers

TO EASY FM & TV SERVICING

McMurdo
SILVER

The big profits in service lie in repairing FM and TV receivers — of which thousands are already in use. Fast, efficient service demands *visual alignment* of sound and video i.f. amplifiers. McMurdo Silver, world-famous builder of Laboratory Caliber Electronic Test Instruments, gives you the quick, accurate answers. Use 909 or 911 with any good 'scope, follow the simple, clear pictorial instructions and you'll master FM and TV alignment in "no time flat."

911 FM/TV SWEEP SIGNAL GENERATOR WITH CRYSTAL MARKER OSCILLATORS.

Covers 2 thru 226 megacycles in three bands upon accurately calibrated 3-range dial without band-switching! Output variable from zero to 1/2 volt. One graduated knob sets linear electronic FM sweep to anything between 40 Kc. and 10 megacycles—low enough for sharp communication FM to high enough for the biggest TV sets. Provides saw-tooth horizontal synchronizing voltage to 'scope at 2x power line frequency giving steady, stable mirror-image trace on your 'scope of i.f. — and r.f. — amplifier selectivity curves. Two panel knobs control amplitude of marker-frequency "pips" produced by two built-in low-drift 1 and 5 mc. crystal oscillators. These marker "pips" let you determine precisely correct pass-band in TV i.f. alignment . . . also serve as standard-frequency signals for checking calibration of *all* types of receivers, signal generators, etc.



\$78.50*

909 FM/TV SWEEP SIGNAL GENERATOR.

Already America's most popular sweep signal generator. Model 909 is identical to Model 911 above except that it does not include crystal marker oscillators — uses your present AM signal generator to provide variable-frequency marker "pips" when desired. Using any good 'scope and following the clear, concise pictorial instructions, Model 909 makes you master of FM and TV visual alignment . . . the only method guaranteeing fast and perfect i.f. alignment. Thousands already in use by smart service technicians and in the laboratories and factories of FM and TV set manufacturers prove it to be exactly the instrument you have demanded. Convenient portable size matches all Silver LCETI — turns your shop into a modern service laboratory.



\$48.50*

*Prices slightly higher West of Rockies.

Send for 1948-1949 Catalog of NEW LCETI Test Instruments

OVER 37 YEARS OF RADIO ENGINEERING ACHIEVEMENT

McMurdo Silver Co., Inc.

EXECUTIVE OFFICES: 1240 MAIN ST., HARTFORD 3, CONN.
FACTORY OFFICE: 1249 MAIN ST., HARTFORD 3, CONN.

**LABORATORY
CALIBER
ELECTRONIC
TEST
INSTRUMENTS**

RADIO-CRAFT for

Get Your ALLIED Catalog Now
Get More for Your Money in Every Way
Get Everything New in Your Radio...

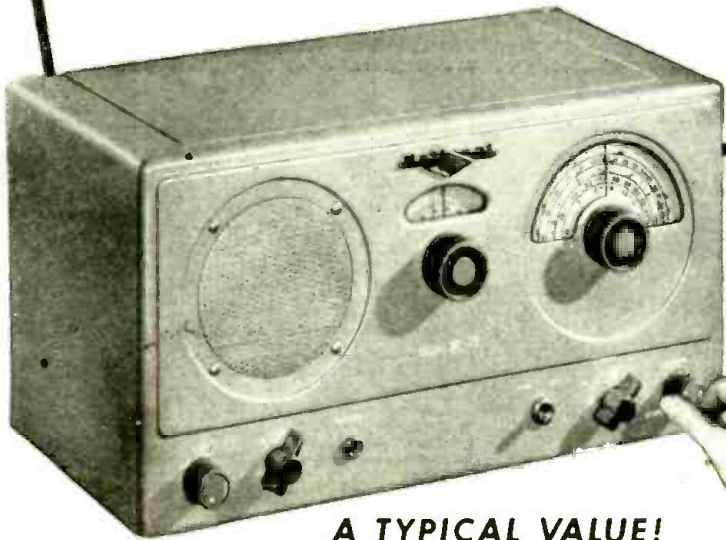

A TYPICAL VALUE!

The New NATIONAL NC-33 Receiver
Packed with Professional Features—A Great Buy!

NOW—enjoy the thrill of owning the National NC-33, the sensation-ally brilliant new communications receiver. It's built to highest engineering standards—easy to operate—delivers top-notch reception on broadcast and short-wave bands. Perfect for SWL's and beginning Amateurs. Covers 500 kc to 35 mc continuously in 4 bands. Main tuning dial is calibrated for easy location of all important amateur, police and foreign bands. Band-spread dial operates over entire frequency range. Has automatic noise limiter; adjustable pitch BFO, universal antenna input; built-in 5" PM speaker; headphone jack; comfortable, glareless tuning dials. Self-contained in attractive modern cabinet, finished in smooth gray. For real enjoyment and dependable all-around performance at nominal cost, the NC-33 takes top honors. Comes complete with tubes. Operates on 105-125 volt, 40-60 cycle AC, or DC. Stock No. 97-596.

NET, FOB Chicago **\$65⁹⁵**

Terms: \$13.19 down, \$5.08 monthly for 11 months.

IMMEDIATE DELIVERY ON THESE FAMOUS NATIONAL RECEIVERS

National HRO-7	\$299.36	National NC-2-40D	\$225.00
National NC-57	89.50	National NC-46	107.40
National NC-173	189.50	NEW! National HFS	
National NC-183	269.00	Receiver-Converter	125.00

Net FOB Chicago. Prices subject to change without notice.
 Attractive Time Payment Terms. Trade-ins Accepted.



FREE

Send for

Radio's Leading Buying Guide
172 Pages Packed with Value

Here's how to get the most for your Radio dollar! Use ALLIED'S great 1948 Catalog, the Buying Guide that brings you everything in radio and electronics at lowest, money-saving prices. ALLIED has everything for Servicemen, Soundmen, Engineers, Amateurs and Builders. Complete selections of latest home radio and Television receivers, test equipment, P. A. Systems and amplifiers, Amateur gear, thousands of parts, tubes, kits, tools, books — ready for fast shipment. Get the advantages of the most famous service in radio — expert handling, helpful personal attention, money-saving values! Send today for your copy of the ALLIED 172-page Catalog — the most complete in Radio.



Everything in Radio
for Everyone in Radio

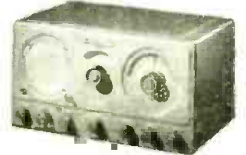
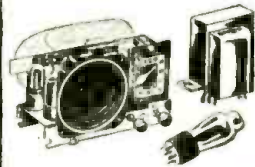

Send for Radio's
Leading Buying Guide

FREE



**THE WORLD'S
 LARGEST
 RADIO
 SUPPLY
 HOUSE . . .**



ALLIED RADIO CORP.
 833 W. Jackson Blvd., Dept. 2-F-8
 Chicago 7, Illinois

- Send FREE 172-Page ALLIED Catalog.
- Enter order for National Model
- Enclosed \$..... Full Payment
- Part Payment (Balance C.O.D.)
- Send ALLIED Easy Payment Plan details and order blank.

Name _____
 Address _____
 City _____ Zone _____ State _____

CATHODE RAY TUBES

5BP1...\$1.20



3BP1—\$1.255FP7—\$1.75
3FP7—\$1.205JP2—\$4.00

THE BEST BUYS
"Communications"
LOWEST PRICES

TUNING UNITS



From RC 191 & RC 375 TT 618, 3000 kc to 4500 kc. TU 9B-7700 to 10,000 kc. TT 10B-10,000 to 12,500 kc. TU 22 R 350 to 650 kc. TT 26 R 200 to 500 kc. Will supply closest unit to Specified Frequency at time of shipment. Each.....\$2.25

TRANSFORMERS

All Primaries—117 V 60 cycles

5102: 1080 vct @ 55 ma, 6.3 v. @ 1.2 amp, 6.3 v. @ 1.2 amp.....\$2.35
5110: 1100 v. @ 70 ma, Gapped @ 550 v. (for use with H. W. rect.).....\$2.75

FILAMENT TRANSFORMERS

5123: 6.3 vct @ 5 amp, 6.3 vct @ 1 amp.....\$2.15
5109: 27 volts @ 8.8 amp, 6.3 v. @ 2.5 amp.....\$2.75
13103: 2.5 v. @ 1.75 amp, 5 v. @ 3 amp, 6.3 v. @ 4 amp, 6.5 v. @ 3 amp.....\$5.35
Distomat Fil. Xfmr. Two 5.1 v. windings @ 5 amp, each, 15,000 volt test.....\$7.50
No. 5058: 6.3 VCT @ 2A, 6.3 VCT @ 2A.....\$2.25
No. 5100: 6.3 VCT @ 1.2 A, 5000 V test.....\$1.35
No. 5056: 6.3 VCT @ 0 A, 6.3 VCT @ 2.2 A, 6.3 VCT @ 2.2 A.....\$2.90
No. 5057: 6.3 VCT @ 1 A, 5 VCT @ 3 A, 5 VCT @ 3 A.....\$2.50
UX 6899: 5 V @ 5.5 A, 5 V @ 5.5 A, 29,000 Volt Test.....\$24.50

POWER CHOKES

6 Hy @ 150 ma.....\$1.50
1 Hy @ 800 Ma, 7.5 Ohms.....\$6.95
Dual Choke: 2-2 Hy @ 100 Ma.....\$.90
Dual Choke: 7 Hy @ 75 Ma, 11 Hy @ 60 Ma.....\$1.50
8.5 h @ 125 ma.....\$1.10
25 h @ 65 ma.....\$1.10

MODULATION TRANSFORMERS

Push pull 807 c.B. to plates and screens of 2 807's in parallel.....\$1.65
Push pull 211's c.B. to plate of 5inKle 211.....\$1.95

ARC-5 ACCESSORIES

CONVERSION COILS FOR ARC-5 TRANSMITTERS

M.O. Coils	P.A. Coils	Antenna Loading Coils	Freq. Range
\$1.00 each	\$1.00 each	\$.85 each	
# 6029	# 7247	# 6033	3-4 Mc.
# 6030	# 9293	# 6034	4-5.3 Mc.
# 6032		# 6035	7-9.1 Mc.

CONVERSION KIT, consisting of 1-M-O coil, 1-P.A. coil, 1-ANTENNA COIL. In any one particular frequency range.....\$2.00

ARC No. 6558 variable receiving capacitor, 62 mmf/section, 3 sections, .03" spacing, 8 rotors. Worm drive ratio 33:1.....\$1.75
ARC No. 4990, variable Xmitg capacitor, 22.4-145 mmf, .05" spacing, 11 rotors, Each.....\$1.00
ARC 5632 Var. Xmitg. capacitor, 29.2-117 mmf, .06" spacing, 14 rotors, worm drive: 90:1.....\$1.00
Single revr. mtg. racks.....\$1.50
Dual mtg. racks (revr.).....\$1.50
Shock mounts for rack.....\$.50
DUAL CONTROL BOXES FOR RCVR'S.....\$1.00

INSULATORS

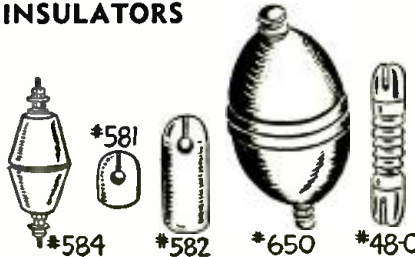

650: Lapp-bowl feed thru. Similar to National NS 3. Made of high quality glazed porcelain. Fits 2 3/4" hole, 6 3/4" L x 3" diam.....\$1.50
584: Feed-thru. Made of stearite. Similar to National NS 1. Fits 1 1/2" hole, 5" L x 1 3/4" diam.....Ea. \$.49 or 4 for \$1.50
582: Antenna feeder support. Holds twinax line also. 3" L x 1 1/4" diam. Hole size: 3/8".....Each \$.17 or 10 for \$1.00
581: Same as # 582, except it is 1 1/2" Long.....Each \$.12 or 12 for \$1.00
48-C: Antenna support insulator. Made of fine quality stearite, with nickel plated reinforced ends. Non-corrosive 4" L x 3/4" diam.....Ea. \$.25

DYNAMOTORS



PE 73 CM(G.E.) Power supply for RC 375 Input: 28 VDC Output: 1000 VDC @ 350 Ma. New.....\$4.95
RD 77KM Power supply for RC 191 with spare fuse links, etc. Input 14 v.d.c. Output 1000 v. @ 350 ma. New \$9.95; Army Release, ex. cond.....\$5.95

PE 101-C Input 13/26 VDC @ 12.6/6.3 A. Output: 400 VDC @ 135 Ma. 800 VDC @ 20 Ma. 9 VAC @ 1.12 A, new.....\$3.49

PE 86 N, Input: 28 VDC, Output: 250 VDC @ 60 ma With filter.....\$1.95

DAG 33A Input: 18 VDC @ 3.2 A, Output: 450 VDC @ 60 Ma.....\$2.45

DM 23: Input 28 VDC @ 7 Ma. Output: 540 VDC @ 250 Ma. Power supply for SCR 274 modulator.....\$3.95

DM 23:50: Input: 27VDC @ 1.75 A, Output: 285 VDC @ 75 Ma.....\$3.50

DM 21: Input: 14 VDC, Output 235 VDC @ 90 Ma. Power supply for RC 312.....\$2.49

PE 55, Input: 12 vdc @ 25 amp, Output 500 vdc @ 400 ma. (slightly used).....\$4.95

RD-AR 93, Input: 28 vdc @ 3.25 amp, Output: 375 vdc @ 150 ma. Pioneer, New.....\$4.95

MP 10 G Power supply, using 2 dynamotors. Input: 24-28 vdc, Output: 1000 vdc @ 400 ma. 230 vdc @ 100 ma. New, complete with relays, filters, etc. BEN-DIX.....\$40.00

B-19 power pack (dynamotor). Input: 12 vdc @ 9.4 amp, Output: 275 vdc @ 100 ma. 500 vdc @ 50 ma. New, complete in metal case with 2 plugs, filters, etc.....\$6.95

DM 28-R, Input: 28 v.d.c. @ 1.25 amp, Output: 270 v.d.c. @ 70 ma. New, with enclosed terminal box.....\$3.25

ZA/USA .0515, Input: 12/24 v.d.c. @ 4/2 amp, Output: 500 v.d.c. @ 50 ma. Compact square shape, size 7 1/2"x1 1/4"x3".....\$3.95

ZA/USA .0516, Input: 12/21 v.d.c. @ 8/4 amp, Output: 275 v.d.c. @ 110 ma, 12 v.d.c. @ 3 amp. Compact square, size 7 1/2"x4 1/4"x3".....\$4.25

DM-25: In 12VDC 2.3A Out 250VDC 50 ma.....\$2.49

DM-42: In 14VDC, Out 515/1030 VDC 215/260 ma and 2/8VDC.....\$3.95

INVERTERS

PE 206-A, Input: 28 v.d.c. @ 38 Amp, Output: 80 volts @ 500 volt-amp, 800 cy. Leland Electric. New, complete with instruction book, relays, filters, etc.....\$12.50
PE 218—Input: 25-28 v.d.c. @ 92 amp, Output: 115 volts, 1500 volt amps, 380/500 cy. Leland Electric. New.....\$35.00
Used, Ex. cond. New.....\$20.00

MICROWAVE TUBES

(Magnetrons)

Tube	Freq. Range	Pk. Pwr.	Out.	Price
2131	2820-2860 mc	285 Kw		\$15.00
2121-A (725-A)	9345-9105 mc	50 Kw		\$25.00
2122	3267-3333 mc	265 Kw		\$15.00
2126	2592-3019 mc	275 Kw		\$15.00
2127	2945-2992 mc	275 Kw		\$15.00
2131	2820-2860 mc	285 Kw		\$15.00
2132	2780-2820 mc	285 Kw		\$15.00
2138	PKG. 3249-3263 mc	5 Kw		\$25.00
2155	PKG 9345-9405 mc	50 Kw		\$25.00
3131	24.00 mc	35 Kw		\$17.50
W.E. 700-A	680-710 mc	100 Kw		\$30.00
W.E. 720-BY	2800	1000 Kw		\$25.00

MAGNETS for 2121-A (725-A), 2122, 2126, 2127, 2131, 2131, 2132 and 3131, each.....\$8.00

Field Strength (Gauss)	Distance Between Pole Faces	Pole Face Diameter	Price
4850	1 1/2"	1 1/2"	\$8.00
1500	Adjustable	1 1/2"	\$8.00
(Electromagnet)	2 3/4" to 3"	2 1/2"	\$12.00
Klystron—2K25-725A			\$7.75

MINE DETECTOR AN/PRS I

Will indicate buried metallic & nonmetallic objects, such as water pipes, sewer pipes, tree roots, water pockets, etc. Uses earphones and meter for aural and visual indicators. Operates on principle of changes in radiation resistance. An ideal gadget for campers, geologists, home-owners. New, complete.....\$12.75
With Batteries.....\$21.65

GERAMICON CAPACITORS

(Eric, Centralab) \$7.50 per 100

2 mmf.....±5%	67 mmf.....±20%
5 mmf.....±5%	100 mmf.....±5%
4 mmf.....±5mmf	115 mmf.....±2%
8.5 mmf.....±.5 mmf	120 mmf.....±5%
11 mmf.....±.5%	240 mmf.....±3%
15 mmf.....±2.5 mmf	250 mmf.....
48 mmf.....±2%	500 mmf.....+ 15 - 30%
50 mmf.....±20%	1000 mmf.....±5%
60 mmf.....±3%	

SILVER-MICA BUTTON CAPACITORS

(Eric, Centralab) \$9.50 per 100

185 mmf.....±2.5mmf
175 mmf.....±2.5mmf
500 mmf.....±10%

ANTENNA, AN/122-A. Used in 4-element adcock arrays for high gain and directivity, each diode element is 12" long, made of 3/4" tubing. Excellent for that new 6 or 2-meter beam. Don't miss this great value.....\$5.65 each or 4 for \$20.00

ANTENNA AN/104-A. The famous ax-handle antenna, used with the SR 522. Ideal for mobile quarter wave, because of its streamline construction; or 2 units can be used to form a dipole for 2 meters or for TV and FM reception. Consists of copper sheath 21" long moulded about a wooden support, with 83-1R coax connector, \$.75 ea., or 2 for \$1.35.

AN/128-A. For high gain and directivity on 2 meters. Consists of 2 vertical elements working against a square reflector, approx. 3'x4'. Impedance is 50 ohms.....\$40.00

140-600 MC DIRECTIONAL ANTENNA

140-310 Mc cone and 300-600 Mc cone, each consisting of 2 end fed half wave conical sections with enclosed matching stub for reactance changes with changing frequency. New, complete with mast, guys, cables, carrying chest.....\$49.50

Control Unit BC 1073

Consists of Pulse-generator and wavemeter which measures frequencies from 150 to 210 mc. The pulse generator makes an excellent square-wave generator with variable pulse-widths. The wavemeter can be modified into a UHF oscillator, 117 VAC, 60 cps operation. W/Tubes.....\$50.00

SONAR SOUND DETECTION UNIT

Ideal for detecting under water sounds, such as fish swimming in schools, within a 15 mile area. Using a Rochelle salt crystal, which is about 1000 times more sensitive than quartz. It is completely enclosed in a solid rubber sheath. This sound detector was originally used in harbor defense. Coupled to an audio amplifier this can be found to have many valuable applications. It's the Model JH which contains 7 microphone units.....\$12.50

GIBSON GIRL EMERGENCY XMTR

Transmits automatic SOS signal on 500 kc emergency wave. Can be manually keyed to transmit additional information. No Batteries required. Hand cranked.....\$25.00



RELAYS

BO 6D35 DPDT, 18-28 vdc, contacts 10 amps @ 115 vac.....\$1.25
7220-24 Contactor, SPST, 24-28 vdc, contacts 400 amps.....\$1.20
1077H, Antenna changeover, DPDT, 28 vdc.....\$1.15

MINIATURE RELAYS

(Approx. size: 1 1/2"x1"x1 1/2")
4PDT, 22-28 vdc, # BA 10059-11 \$.70
DPDT, 22-28 vdc, 300 ohms.....\$.60
SPDT, 24 vdc, 300 ohms, 10031 55836.....\$.60

HEADSETS

Dynamic mike and headset combination. A high quality, eminent unit, used in B-19 tank Xmters. Mike and phones complete, new.....\$2.75
R-15 headsets: 8000 ohms impedance, rubber cushions, comes with 8" cord and plug PL 55. New.....\$1.95
HS 30 headset. Insert type headset cuts out background noise and low impedance (500 ohms) assures efficiency and high fidelity. A MUST for every ham at this price.....\$.85
Xfmr to match 8000 ohms output, \$.35

All merchandise guaranteed. Mail orders promptly filled. All prices, F.O.B. New York City. Send Money Order or Check. Shipping charges sent C.O.D.

COMMUNICATIONS EQUIPMENT CO.

131 C. Liberty St., New York City 7, N. Y.

Digby 9-4124



CROSS POINT INDICATOR

Two 0-200 microampere movements, 3" case, many applications.....\$2.50



I Put You to Work with Your Hands to LEARN RADIO!
You Build Receivers! You Make Typical Defects Occur
and Make Tests to Prove the Theory!

YOU GET
8 BIG KITS OF RADIO
PARTS & EQUIPMENT
including
2-BAND SUPER
RECEIVER!
and **16 RANGE METER**
FOR TESTING

F. L. SPRAYBERRY, PRES-
IDENT of the SPRAYBERRY
ACADEMY OF RADIO. This
is the man who directs
your study. His years of
experience and Radio
"know-how" assure you of
the finest in home Radio
Training!

LEARN RADIO to MAKE MONEY!

LOW COST TRAINING — EASY PAYMENT PLAN!

You Learn at Home How to
Build and Test Dozens and
Dozens of Circuits — Simple
and Complex!

YOU DO
OVER 175
INSTRUCTIVE
EXPERIMENTS



YOU BUILD
ALL THESE TESTERS
..... AND MORE!

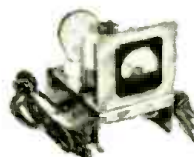

I give you a fine,
moving-coil type
Meter Instrument
on Jewel Bearings
— with parts for a
complete Analyzer
Circuit Continuity
Tester. You learn
how to check and
correct Receiver
defects with professional speed and
accuracy.

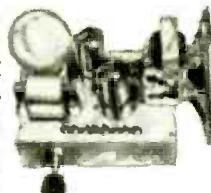

You'll get
valuable ex-
perience and
practice
building this
Signal Gen-
erator and
multi-
purpose
Tester.
Makes a
breeze out of fixing Radios and you
don't have to spend money on ready-
made Equipment.

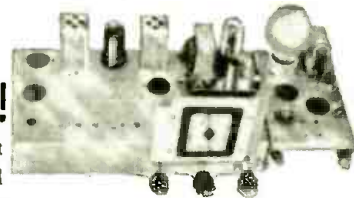

Soldering, wiring, connecting Radio
parts . . . building circuits with your
own hands — you can't beat this
method of learning. When you
construct this Rectifier and Filter,
Resistor and Condenser Tester, etc., you
get a really practical slant on Radio
that leads to a money-making future.

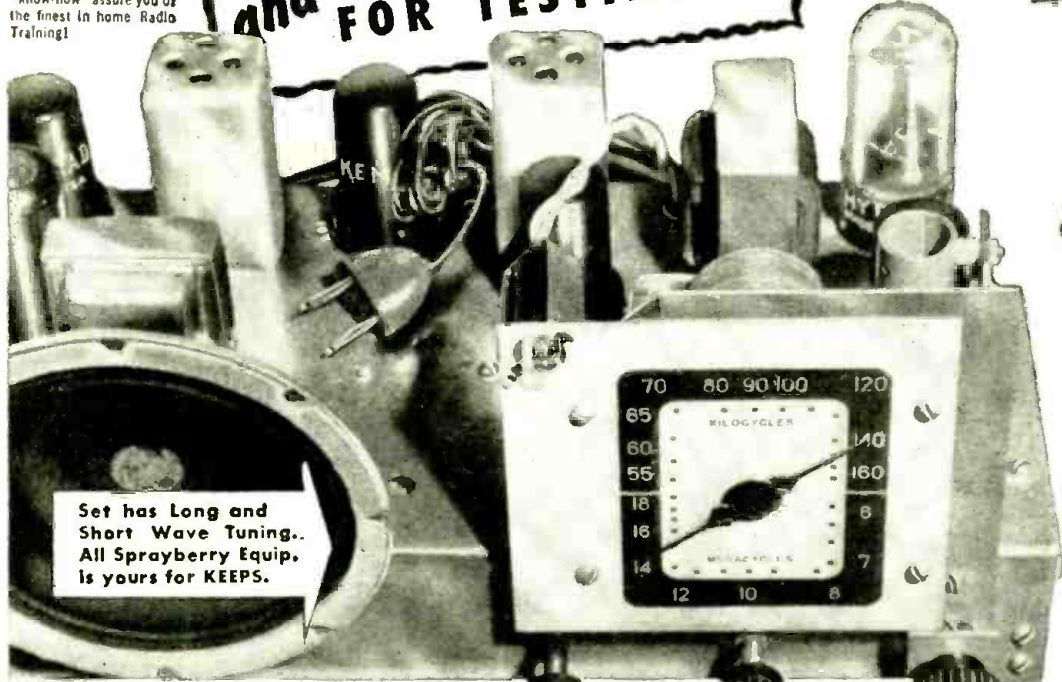

Set has Long and
Short Wave Tuning.
All Sprayberry Equip.
is yours for KEEPS.

SPRAYBERRY HOME TRAINING is PLANNED to MAKE MONEY for you FAST!

I train you with regular professional Radio Equip-
ment. I tell you exactly what to do . . . how to do
it. You handle Radio Parts, see them operate,
learn what they're for. With the fine Kits I supply,
you learn how to build Radio Circuits, construct
your own Test Equipment. I'll show you how to
cause typical Radio defects so you can watch and
see how they act. You learn the latest methods for
trouble-shooting and repair. All this adds up to

the finest kind of "bench" experience. And you get
it right in your own home. In no time at all, you'll
be ready for a business of your own or a good job
in Radio, FM, Television,
Radar, Industrial Elec-
tronics, etc. Now's
the time to get
started!

VETERANS!
Approved for
G.I. Training
Under Public
Laws 16 and 346.
Mail Coupon
for Full
Details.

**SEND FOR MY
VALUABLE
FREE BOOKS!**

"How To Read Radio Diagrams and Symbols"
A wonderfully complete new book, which explains in
simple English how to read and understand any Radio
Set Diagram. Includes translation of all Radio sym-
bols. Send for this volume at once! It's free! With
it I'll send you another Big Free Book, describing in
detail my Radio Electronic Training!

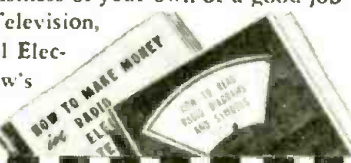

SPRAYBERRY ACADEMY OF RADIO
F. L. Sprayberry, President
Room 2068, Sprayberry Building, Pueblo, Colorado
Please rush my FREE copies of "How to MAKE MONEY in RADIO, ELEC-
TRONICS and TELEVISION" and "HOW to READ RADIO DIAGRAMS and
SYMBOLS."
 Check here if a veteran.

Name Age

Address

City State

(Mail in envelope or paste on penny postcard)

SAVE ON SURPLUS!

CATHODE RAY TUBES

- 3 CP 1 (Ind. Screen) .95
- 3 DP 1-A (Ind. Screen) .95
- 3 FP 7-A 1.35
- 3 HP 7 1.45

(add 25c each to cover postage and handling)

- 5 FP 7 1.75
- 5 CP 1 1.95
- 5 BP 1 2.45
- 5 HP 1 2.45

(add 35c each to cover postage and handling)

- 7 BP 7 2.65
- 7 CP 1 3.25

(add 40c each to cover postage and handling)

- 9 GP 7 3.50

(Shipped express, charges collect)

ALL NEW!



Command Set Antenna Relay \$1.95

Antenna Relay Unit BC-442A or RE-2/ARC-5. Originally used on Command Set (SCR-274). Contains an antenna change-over relay, a 19 1/2 millivolt meter, with an external 3/4 amp. thermo-couple. The meter scale reads R.F. current on a linear scale calibrated 0 to 10. All new. A truly sensational buy at only \$1.95 (add 25c to cover postage and handling).

Clearance Specials!

NOTICE

We need room. That's why we're slashing our already sensational prices on these limited quantity items. Our stock is definitely limited, so rush your order now, to be sure not to miss any of these unusual bargains.

LOOP ANTENNA



A NEVER AGAIN BUY \$3.95

Used primarily on aircraft & Marine ADF Systems, Loop LP-21-A contains an electric motor and selsyn. These loops have been removed from salvage aircraft, but are guaranteed to be in excellent working condition.

Shipped Express Collect

FORMATION STICK

Originally used in conjunction with the Automatic Pilot. Contains innumerable gears and resistors; a potentiometer and Centrifugal Governor. Really a gadgeteer's paradise, and a truly unusual buy at only \$1.95. (Add 40c to cover postage and handling.)

500' \$2.95

3 CONDUCTOR TELEPHONE WIRE

3 conductor Braided insulated copper & steel telephone wire. It is made of copper for conductivity, and steel for strength. Worth at least 3c per ft. Yet due to an exceptional buy, we can now offer it at less than 1c a ft.

Shipped Express Collect

BC 450 CONTROL BOX

Triple remote control box for Command Receivers (SCR 274 N Series). Equipped with 3 tuning dials, 3 volume controls, and 6 selector switches. Used, but in excellent condition, a steal at only \$1.50 ea. (Add 25c to cover postage and handling.)

BRAND NEW MINE DETECTOR \$9.50

complete (except batteries) in original case. Each unit contains an instruction Manual. Good for detecting objects under the earth's surface. Requires one 6 volt and three 4.5 volt batteries. (Shipped express charges collect)

RADIO COMPASS WORTH A LOT MORE

RS/ARN7 or 433G, either of these Radio Compass Receivers complete with tubes. Ideal for conversion for home reception. Used but good. A real buy at only \$14.95. (Shipped express collect)

PHANTOM ANTENNA 85¢

A transmitting antenna, for use an approximately 450 MC. Complete with standard coax connector. A weather-proof unit. (Add 25c to cover handling and postage).

STEEL OXYGEN TANK

These tanks are approximately 44" long by 6" in diameter. They will stand up to 400 lbs. pressure, and have an outlet on either end threaded with standard 1/4" pipe thread. A real buy at only \$1.50. (Shipped Express Charges Collect.)

7.95 12VOLT 50AMP Generators 9.45

These generators are excellent for truck or bus use. They also will make a fine power supply for your radio shack or nice light welder. Brand new in original boxes as pictured with pulley, \$9.45 each or with keyed shaft less pulley - \$7.95 each. (Shipped Express Collect)

LIMITED SUPPLY AT

ALL NEW!

ONLY! \$22.50

LS-1 Squadron Signal Generator (Navy Type CML-60049) used for Type ZA Glide path equipment. Frequency range 90-95 mc. Amplitude modulated - variable frequency; audio oscillator tuned to 60 cycles. R F level measured by self contained VTUM. Contains 0-50 micro-amp meter.

Shipped Express Collect

NO C. O. D. ORDERS

IMPORTANT!

NOTE

Due to customs regulations which require excessive paperwork and packaging complications, we cannot accept orders for shipment outside the United States or its possessions.

Recording Wire \$1.49

.006 Stainless Steel recording wire. New on original spools as used by Army and Navy recorders. Each spool contains at least 1/4 mile of wire. Can be used on standard wire recorders. Add 25c to cover handling and postage.

All merchandise subject to prior sale, minimum order \$2.00, No C.O.D. orders accepted. Michigan residents must add 3% State sales tax.

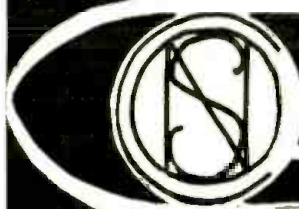

N. SILVERSTINE CO.

6532 EAST McNICHOLS ROAD DETROIT 12, MICHIGAN

"Seven Acres of Surplus"

RADIO-CRAFT for

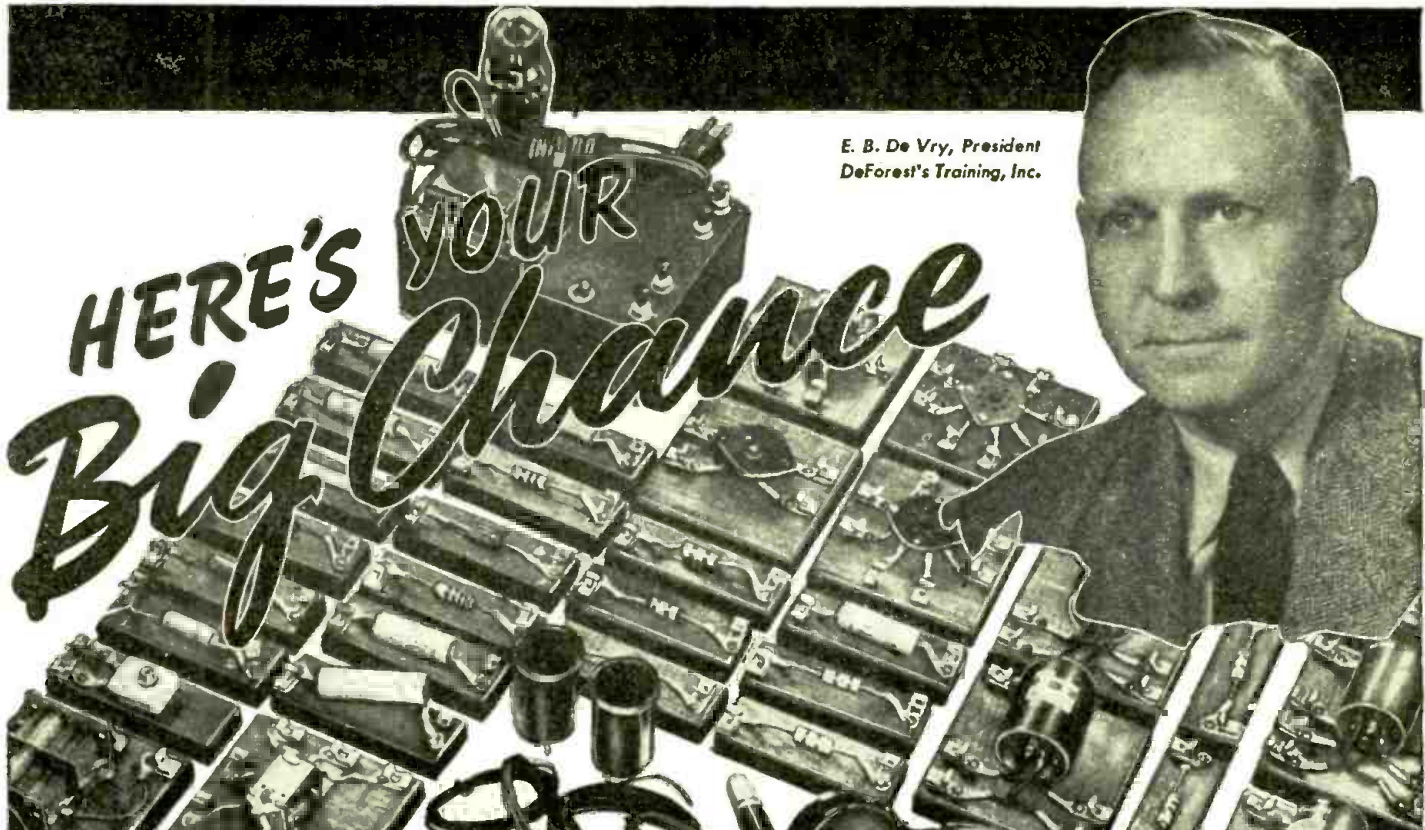

E. B. DeVry, President
DeForest's Training, Inc.

HERE'S YOUR Big Chance

Profit Through Training in RADIO-ELECTRONICS

Prepare at HOME or in our CHICAGO LABORATORY to get REAL MONEY, a BETTER JOB, or a BUSINESS OF YOUR OWN

Our business is helping men . . . and young men . . . get into a well-paying future in the highly profitable fields of RADIO-ELECTRONICS. During the past sixteen years we have trained many men who desired better jobs or businesses of their own. We can effectively provide you with this same opportunity either in our new, modern Chicago laboratories or in the privacy of your own home.

TAKE YOUR CHOICE

If you choose to come to Chicago, we shall find comfortable living quarters for you. If you train at home, we shall send you modern, practical equipment. In either of these two methods, you will have the supervision of some of the finest instructors in the country. Fill in coupon below and we shall send you, absolutely FREE, full information about our program of building men for better opportunities in RADIO-ELECTRONICS. DeForest's Training, Inc. also includes instruction in FM Radio, Television and Industrial Electronics.

If you prefer to remain at home, you receive eight (8) big kits of radio parts and assemblies from which you can work out dozens of fascinating radio circuits to gain practical experience in your own home. In addition, you receive a 16 mm. motion picture projector and 12 information-packed reels of film which help you learn faster . . . easier. You also get modern looseleaf lessons with handy fold-out diagrams.

EMPLOYMENT SERVICE

When you complete your training our effective Employment Service helps you get started toward a real future. Mail coupon below today . . . do not delay.

VETERANS

Both our (1) Chicago Laboratory and (2) Home Study training are accepted under the "G. I. Law." If you qualify, the Government will pay cost of either training you select.

MAIL THIS OPPORTUNITY COUPON NOW!

Mr. E. B. DeVry, President
DeForest's Training, Inc.
2533 N. Ashland Ave., Dept. RC-E6
Chicago 14, Illinois

Please show me how I may get started toward a good job or a business of my own in Radio-Electronics.

Name.....Age.....

Address.....Apt.....

City.....Zone.....State.....

If under 16, check here for special information.

If a discharged Veteran of World War II check here.

DeForest's Training, Inc.

CHICAGO,
ILLINOIS

Associated with the DeVRY Corporation
Builders of Movie & Electronic Equipment

JUNE • 1948 — Special FM Issue

EDITORIAL

The Rising Tide of FM by Hugo Gernsback 17

COVER FEATURE

Frequency Modulation—1922 and 1948 by Edwin H. Armstrong 20

FM (Pages 21-61)

FM Fundamentals	by John B. Ledbetter	21
FM Receivers		22
FM Sweep Generators	by Bob Stang	25
Advantages of FM	by Leigh L. Kimball	26
FM Tuners		28
FM Receiver Servicing Technique	by Milton S. Kiver	30
Simplified FM Receiver Uses Crystal Detector	by Robert E. Altomare	32
FM Discriminator Circuits	by Douglas H. Carpenter	34
FM Receiving Antennas	by H. W. Secor	36
FM Receiver From War Surplus Radio BC-624	by Robert C. Paine	38
Complete FM Station List		40
Glossary of FM Terms	compiled by John B. Ledbetter	44

Foreign News (Page 68)

Report From Britain by Major Ralph W. Hallows 68

Construction (Page 69)

Modern Crystal Receiver by W. V. Nutall 69

Servicing (Pages 71-74)

Return of the Veteran by Emmett Brightwell 71
 Production-Line Technique for Service Shops by Jack King 72

Audio (Pages 75-76)

Connecting FM Tuners by Albert Loisch 75

Amateur (Pages 77-79)

A Sailplane Transmitter by Fritz Compton 77

Test Instruments (pages 80-81)

Economy Voltmeter by Homer L. Davidson 80

Departments

The Radio Month	18
Technotes	46
Radio-Electronic Circuits	62
New Patents	64
Question Box	66
Try This One	67
New Devices	70
Communications	82
Book Reviews	87

"NEW LOOK" FOR RADIO-CRAFT

For the greater convenience of our readers, RADIO-CRAFT introduces a new format this month. All articles on the same subject are grouped together, "Sign-posts" are placed on each page, identifying the subject. Continuations (except where unavoidable) will be eliminated in the next few issues. We trust you will like the new classified and systematized RADIO-CRAFT. Let us have your reactions!



Incorporating
SHORT WAVE CRAFT* TELEVISION NEWS*
RADIO & TELEVISION
 *Trademark registered U. S. Patent Office

- HUGO GERNSBACK**
Editor-in-Chief
- FRED SHUNAMAN, *Managing Editor*
- M. HARVEY GERNSBACK,
Consulting Editor
- ROBERT F. SCOTT, W2PWG,
Technical Editor
- ANGIE PASCALE,
Production Manager
- I. QUEEN, W2OUX, *Editorial Associate*
- ELMER FULLER, *Shortwave Editor*
- G. ALIQUO, *Circulation Manager*
- JOHN J. LAMSON,
Advertising Director
- ALFRED STERN, *Promotion Manager*

In Our Next Issue

INGENIOUS TEST INSTRUMENT
 TELEVISION POWER SUPPLY
 DOUBLE BRIDGE VOLTMETER

On the Cover:



Major Edwin H. Armstrong, Father of FM, in the shadow of one of the latest antennas used for FM broadcasting.

Chromatone by Alex Schonburg



ABC PAID CIRCULATION 6 MONTHS TO DEC. 31, 1947—102,688. (Publishers Statement)

PRINTED FOR JUNE ISSUE—153,000.

RADCRAFT PUBLICATIONS, INC. Hugo Gernsback, President; M. Harvey Gernsback, Vice President; G. Aliquo, Secretary

Contents Copyright, 1948, by Radcraft Publications, Inc. Text and illustrations must not be reproduced without permission of Copyright owners.

RADCRAFT PUBLICATIONS INC. • PUBLICATION OFFICE 29 Worthington Street, Springfield 3, Mass. Address all correspondence to N. Y. office.
 EDITORIAL AND ADVERTISING OFFICES 25 West Broadway, New York 7, N. Y. Telephone REctor 2-9690. BRANCH ADVERTISING OFFICES: Chicago: 308 W. Washington Street, Chicago 6, Ill. Tel. Randolph 7363. Detroit: Frank Holstein, Manager, Room 402 Lexington Bldg., 2970 West Grand Blvd., Detroit 2, Mich. Telephone Madison 7026-7. Los Angeles: Ralph W. Harker, Manager, 606 South Hill St., Los Angeles 14, Calif. Tel. Tucker 1793. San Francisco: Ralph W. Harker, Manager, 582 Market St., San Francisco 4, Calif. Tel. Garfield 1-2481.

RADIO-CRAFT, June, 1948, Volume XIX, No. 9. Published monthly on 25th of month preceding date of issue. Allow one month for change of address. When ordering a change, please furnish an address stencil impression from a recent wrapper. All communications about subscriptions should be addressed to the Circulation Manager, Radio-Craft, 29 Worthington St., Springfield 3, Mass., or 25 West Broadway, New York 7, N. Y.

SUBSCRIPTION RATES: United States and possessions, Mexico, Central and South American countries, \$3.50 a year; \$6.00 for two years; \$8.00 for three years. Canada, \$4.00 a year; \$7.00 for two years; \$9.50 for three years. All other foreign countries, \$4.25 a year, \$7.50 for two years; \$10.25 for three years.

FOREIGN AGENTS: Great Britain: Atlas Publishing and Distributing Co., Ltd., 18 Bride Lane, Fleet St., London E.C.4. Australia: McGill's Agency, 179 Elizabeth Street, Melbourne. France: Brentano's, 37 Avenue de l'Opera, Paris 2e. Holland: Technisch Bureau Van Baerle, Bemelmans & Co., Heemsteedsche Dreef 124, Heemstede. Greece: International Book & News Agency, 17 Amerikis Street, Athens. So. Africa: Central News Agency, Ltd., Cor. Rissik & Commissioner Sts. Johannesburg; 112 Long Street, Capetown; 369 Smith Street, Durban, Natal. Universal Book Agency, 70 Harrison Street, Johannesburg. Middle East: Steimatzy Middle East Agency, Jaffa Road, Jerusalem. India: Susil Gupta (Distributors) Co., Amrita Bazar Patrika Lt., 14 Ananda Chatterjee Lane, Calcutta.

RADIO-CRAFT for

PHOTOFACT Publications Help You to Success!

Have more practical, useful, complete data than you can get anywhere else...

READY NOW!

PHOTOFACT VOLUME 4

Includes First Three TV Course Installments!

Latest companion to popular Volumes 1, 2 and 3 — brings your file of post-war receiver service data right up to July 1948! Most accurate and complete radio data ever compiled... an absolute **MUST** for all Servicemen. Everything you need to know for faster, more profitable servicing, in handy, unified form. Includes: Exclusive Standard Notation schematics; photo views keyed to parts lists and alignment data; complete parts listings and proper replacements; alignment, stage gain, circuit voltage and resistance analysis; coil resistances; dial cord stringing; disassembly instructions; record changer repair instructions. Order Volume 4 today — it's the *only* service data that meets your *actual* needs!

Your Price
Each Volume,
in Deluxe Binder
\$18³⁹

- Vol. 4. Models from Jan. 1, 1948 to July 1, 1948
- Vol. 3. Models from July 1, 1947 to Jan. 1, 1948
- Vol. 2. Models from Jan. 1, 1947 to July 1, 1947
- Vol. 1. All post-war models up to Jan. 1, 1947

1947 Automatic Record Changer Manual

Nothing like it! Covers more than 40 different post-war models. Absolutely accurate, complete, authoritative — based on actual analysis of the equipment. Shows exclusive "exploded" views, photos from all angles. Gives full change cycle data, adjustment data, service hints and kinks, complete parts lists. Shows you how to overcome any kind of changer trouble. **PLUS** — for the first time — complete, accurate data on leading Wire, Ribbon, Tape, and Paper Disc Recorders. 400 pages; 8½" x 11"; hard cover; opens flat. Don't be without this manual. **ONLY \$4.95**

Radio Receiver Tube Placement Guide

The book that shows you exactly where to replace each tube in 5500 radio receiver models. Covers receivers from 1938 to 1947. Each tube layout is illustrated by a clear, accurate diagram. Saves time — eliminates risky hit-and-miss methods, especially when the customer has removed tubes from the set. A handy pocket-sized 192-page book, indexed for quick reference. You'll use it profitably every single day. Order several copies for your bench and outside calls! **ONLY \$1.25**



**FAMOUS \$500⁰⁰
TELEVISION COURSE
At No Extra Cost to You!**

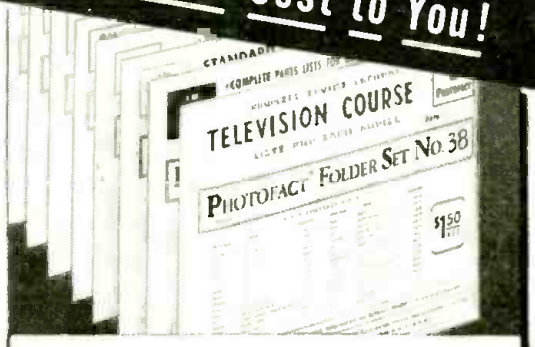

NOW RUNNING IN CURRENT PHOTOFACT FOLDER SETS

Here's the first practical, successfully proved Television instruction for the Service Technician! Now — at no extra cost to you — you can prepare for profitable Television servicing without taking time off from your business. If you can service a Superheterodyne, the **PHOTOFACT** Course will teach you clearly and simply how to service a Television Receiver. Telegrams, letters and 'phone calls by the hundred acclaim the first installment of the \$500 Television Course which appeared in **PHOTOFACT** Folder issues) — be sure to get **PHOTOFACT** Sets No. 38, 39 and 40 today! Stay ahead of the game with **PHOTOFACT!**

Don't Miss a Single Installment!

Dial Cord Stringing Guide



The book that shows you the one *right* way to string a dial cord. Here, for the first time, in one handy pocket-sized book, are all available dial cord diagrams covering over 2300 receivers, 1938 through 1946. Makes dial cord restringing quick and simple. Pays for itself in time saved on a single dial cord repair job. A "must" for every service bench and tool kit. Order today! **ONLY \$1.00**

BOOST YOUR EARNING POWER!

- Mail This Order Form to **HOWARD W. SAMS & CO., INC.**, 2924 E. Washington St., Indianapolis 7, Indiana
- My (check) (money order) for \$.....enclosed.
- Send Photofact Sets — 38, — 39, — 40. (\$1.50 per Set).
 - Send Photofact Volume 4 (including Sets Nos. 31 through 40) in DeLuxe Binder, 18.39.
 - Vol. 3. Vol. 2. Vol. 1 (\$18.39 each).
 - Automatic Record Changer Manual, \$4.95.
 - Tube Placement Guide, \$1.25.
 - Dial Cord Stringing Guide, \$1.00.
 - Send **FREE** Photofact Cumulative Index.

Name _____
Address _____
City _____ State _____

HOWARD W. SAMS & CO., INC
INDIANAPOLIS 7, INDIANA
Export—Ad. Auriema—89 Broad St., New York 4, N. Y.—U. S. of America
Canada—A. C. Simmonds & Sons, 301 King St., East—Toronto, Ontario

PHOTOFACT SERVICE

"The Service that pays for itself over and over again!"



ESSE Specials!

Do not fail to closely examine this list of bargains. We believe that every item listed below is a sensational value that soon can never be repeated. All equipment advertised herein is unconditionally guaranteed to the customer's satisfaction to this extent: Return any item advertised within five days after delivery for full refund except transportation charges (both ways).

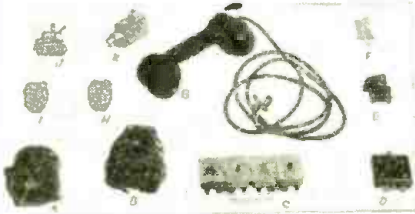

- (A) **IGNITION SWITCH**
3" across face and 2" deep. Has off position or will switch to either or both of two circuits \$1.60
- (B) **BENDIX SCINTILLA MAGNETO SWITCH**
4" high x 4" deep. Contains one off-on toggle type switch, two rotary type switches each with off position and two on positions. \$1.75
- (C) **CUTLER-HAMMER SWITCH ASSEMBLY**
Consists of four DPST bat-handle toggle switches, each rated at 20 amps 125 volts, with connecting straps. Price per assembly of four \$1.00
- (D) **CIRCUIT BREAKER**
30 amps. 2"x2"x3/4". Automatic push to reset. New \$1.50
- (E) **HEAVY DUTY TOGGLE SWITCH**
CH type C-5A DPST 20 A. 125 V. \$3.35
- (F) **HEAVY DUTY TOGGLE SWITCH**
CH type AN-3023-10 DPDT Momentary Contact 30 A. 125 V. \$3.35
- (G) **SOUND POWERED TELEPHONES**
Shipping weight about 7 lbs. per pair. Require no batteries or external source of power. Will operate up to several miles with two wire circuit, or use one wire and ground, lightweight. Brand new. Price per pair \$19.50
- (H) **HEAVY DUTY TOGGLE SWITCH**
CH type C-2 DPDT Center off 30 A. 125 V \$5.50
- (I) **HEAVY DUTY TOGGLE SWITCH**
AN-3022-6B SPDT Center off 30 A. 125 V. \$2.25
- (J) **HEAVY DUTY TOGGLE SWITCH**
CH type AN3027-2B DPST 20 A. 125 V. \$2.25
- (K) **MICRO-SWITCH**
Weather-proof, metal clad. 10 A. 125 V. type YZE.TROTN SPST normally open. ... \$3.35

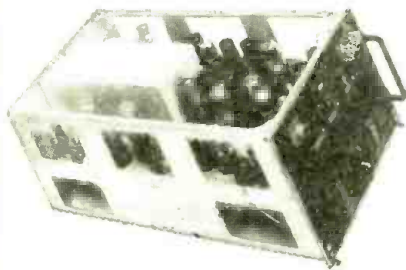

SN8/APQ-5B

Contains 31 useable tubes consisting of 2-6H6's, 3-6AC7's, 2-2050's, 1-6SA7GT, 2-VRI05's, 10-6AG7's, 7-6SN7GT's, 1-VR75, 2-6SL7GT's; 1-6N7. Other parts such as 17 Shallerross precision wire-wound resistors of 30,000, 120,000, 150,000, 250,000, 20,000, 200,000 and 100,000 ohms Value. Relay DPDT, variable condensers, Amphenol and Cannon connectors, tap switches, networks and transformers make this another invaluable parts item at the advertised low price. Weight 28 lbs. Contained in aluminum case 17 1/2" L x 11 1/4" W x 7 1/2" H. **PRICE \$14.95**



LS-3 SPEAKER

6" PM type, housed in heavy metal case. Contains output transformer to match 4000 ohm impedance. Used but guaranteed okay. Size about 8"x8"x4". Shipping weight approx. 10 lbs. Has jack for plugging in cord to receiver. Ideal for BC-348 receiver. **\$8.50**



TYPE CRZ-43AA AIRCRAFT RADIO RECEIVER

Another item for the VHF experimenter. Contains ten tubes: 6-SH7's, 2-6H6's, and 2-7193's. Relays, condensers, resistors Amphenol connectors, dynamotor, carbon pile voltage regulator and numerous other parts. Weight approx. 32 lbs. Size, 12"W x 11"H x 8"D **\$6.95**

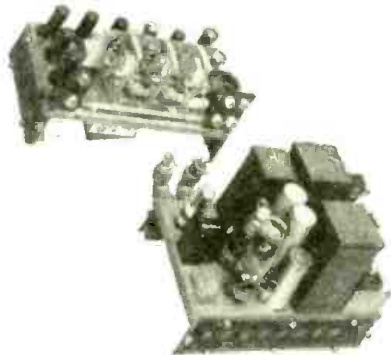

BC-800A RADAR TRANSMITTER & RECEIVER

Loaded with tubes and components for the VHF experimenter. Contains 19 tubes including 1-955, 3-956's, 1-2C26, 1-5U4G, 1-2X2, 1-6SN7, 7-6AC7's, 2-6SL7GT's, 1-6V6GT, and 1-6H6GT/G. Several HF tuned circuits, 7 amphenol chassis fittings, sockets, 24 V. blower and motor (will operate on 110 V. AC), 2-4Mfd. 600 V. condensers, and many other resistors and parts. Weight approx. 40 lbs. In metal case 12 1/2" x 11 1/2" H x 8"D **\$14.95**



DYNAMOTOR PE101C

Size about 4" dia. x 14" long. Shipping weight approx. 15 lbs. Made to order for BC-645A 420 MC. Citizens Band transmitter-receiver. Input 13 or 26 V. DC; output 400 and 800 V. DC and 9 V. AC. Brand new in original sealed cartons **\$3.95**

ARGON INCANDESCENT LAMP
2 watt pear shape with regular AC type screw base. NEW 35c ea.
Sold carton of ten only.

WESTINGHOUSE MERCURY-VAPOR
Battery charger bulbs. Commercial 6A. Style 289416, for screw socket. For 6 or 7 batteries charged at one time—2000 to 3000 hours with special high resisting glass. **\$3.95**
NEW

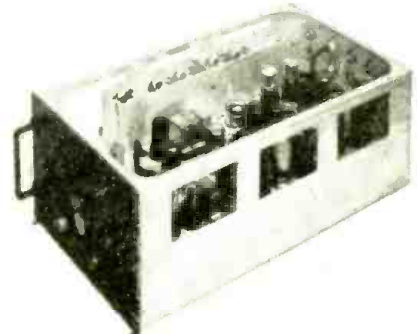

BC-1155-A SYNCHRONIZER

Another Invaluable unit for the Television and VHF experimenter. Contains 19 Mc. IF strip using 5-WE717A tubes. A total of 24 tubes included, consisting of 6-WE717A's, 2-6SL7GT's, 2-6AC7's, 5-6SN7GT's, 2-6N7GT's, 2-6L6's, 1-6V6GT, 2-6AG7's, 1-6AC7, and 1-6H6GT. Other parts included are 6 pots, 10 Amphenol 831R chassis connectors and numerous condensers, resistors, and transformers. Weight 22 lbs. Size 21"L x 11 1/2"W x 7 3/4"H. **PRICE \$17.75**



PP-51/APQ-9 RECTIFIER-POWER UNIT

400 cycle 115 V. Contains 4-5R4GY tubes, 2-4Mfd. 1000 V. DC condensers, 2-1 Mfd. 1500 V. DC condensers, 400-2600 cycle transformers, power resistors, etc. Weight 38 lbs. Size 21"L x 5 1/2"W x 7 3/4"H. **\$4.95**

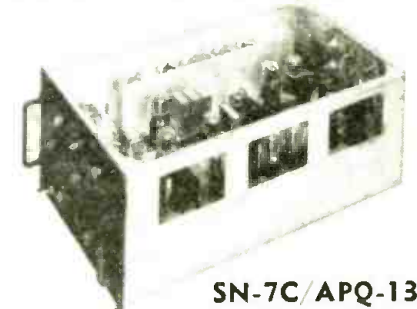

SN-7C/APQ-13

Sensational offer for Television engineers. Contains 19 Mc. IF strip containing 5-WE717A tubes. Other HF strips containing 2-6AK5's, 3-6SL7GT's, 1-WE717A, 4-6SN7GT's, 2-6N7's, 2-6L6's, 1-6H6, 3-6AC7's, 2-6AG7's, 1-6V6. A total of 26 tubes. Other parts such as DPDT relay, 7 pots, 12 Amphenol 831R chassis connectors, and numerous condensers, toggle switches, RF chokes, variable condensers, and transformers. Weight approx. 25 lbs. Size 20"L x 11 1/2"W x 7 3/4"H. **PRICE \$19.50**



PP-2/APQ-5 POWER UNIT

400 cycle, 115 V. Contains 10 tubes as follows: 2-5U4G's, 1-6X5GT, 4-6Y6G's, 1-6SL7GT, 2-VRI50-30's and numerous condensers, transformers and resistors. Weight 17 lbs. Size 21"L x 5 1/2"W x 7 3/4"H. **PRICE \$5.75**

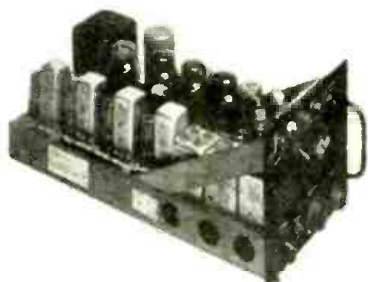

RECEIVER AND POWER SUPPLY FOR APN-4

Contains 16 tubes: 1-6SN7, 1-6SL7, 1-6H6, 4-6SK7, 1-VR105-30, 1-6SJ7, 2-2X2, 1-5U4G, 3-6B4G, 1-6SA7. Shipping weight 32 lbs. **\$19.50**

MARKER-BEACON RECEIVER

Can be adapted to radio controlled devices. Was used by pilots to flash a signal lamp on aircraft range of a beacon transmitter. Responds to modulated signals over a variable range of 62 to 80 Mc. Tube plates and filaments operate directly from 24 V. DC. Can be adapted for radio control of experimental apparatus opening garage doors, etc. Circuit diagram and parts list included on either model shown below:



BC-357—contains 12CB and 12SQ7 tubes and sensitive relay (size 5 3/4" x 5 1/4" x 3 1/4"). **\$2.95**

BC-1033 — contains 6SH7, 6SL7 and 12SN7 tubes, sensitive relay (size 5 3/4" x 5 1/4" x 3 1/4"). **\$3.50**

OXYGEN TANKS



Aviators oxygen breathing bottles. Non-shatterable. Choice of two types.

(A) Withstands 2000 lbs. pressure.

(B) Withstands 500 lbs. pressure.

CHOICE **\$5.95 ea.**



INTERPHONE AMPLIFIER

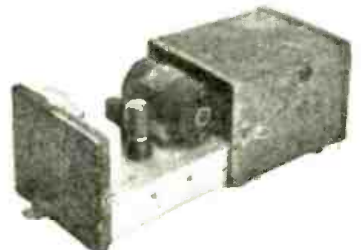

Beautifully constructed in gray finish sturdy metal cabinet. Operates on 24 V. input. Complete with dynamotor. Has 1-6V6 and 1-6SJ7 tube, volume control, carbon or magnetic microphone input. Fastened to sturdy resilient mounting on rubber. Size 6" x 7" x 9". Shipping weight **\$3.45** 14 lbs.



T-26/APT-2 RADAR TRANSMITTER

Contains tunable VHF circuit using 2-JAN CTL 703's or 368AS tubes. Other tubes are: 2-5R4GY's, 1-2X2, 1-807, 1-6AG7, 2-6AC7's, and 1-931A. Other parts such as 24 V. DC motor and blower, HV. condensers and transformers, terminal strips and Amphenol connectors, knobs, fuse holders, etc., make this unit invaluable for parts alone. Weight approx. 45 lbs. Size 21"L x 10 1/2"W x 7 3/4"H, in metal case **\$9.75**

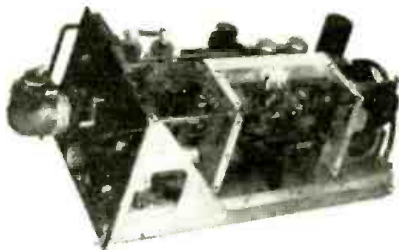

T-39/APQ-9 RADAR TRANSMITTER

Loaded with VHF parts and tubes such as 2-RCA 8012's, 1-931A, 2-807's, 1-6AG7, 2-6AC7's. The RCA 8012's are rated at 50 W. input to 500 Mc. Contains variable parallel-plate oscillator silver plated, ventilating blower and motor, ceramic tap switch, pots, terminal strips, gears, counters, etc. Weight 36 lbs. Size 22"L x 10 1/2"W x 7 3/4"H. PRICE **\$9.75**

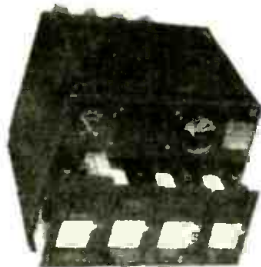

SPERRY A-5 AUTO PILOT AMPLIFIER RACK

Contains 115 V. AC voltmeter and 350-450 cycle Frequency meter. A total of 4 amplifier chassis complete with following tubes included in rack: 2-1631's, 6-1632's, 3-1633's, 3-1634's, and 2-1644 tubes. Numerous transformers, resistors and condensers make this unit invaluable for parts. Weight 38 lbs. Size 12"L x 14"W x 10 1/4"H. PRICE **\$6.95**

SCR-522 TRANSMITTER - RECEIVER

Operates from 100-156 Mc. Easily adaptable to amateur radio, fire department, taxicab purposes, for mobile or fixed station installation. A redhot item for the amateur 6-10-11 meter rig. In excellent condition. Complete with all tubes, dynamotor, and remote control, and not beat-up. Shipping weight 45 lbs. **\$24.95**

Same as above except not in excellent condition and not guaranteed condition **\$14.95**

Dynamotor for SCR-522. Size about 13" x 8" x 5" high. Shipping weight about 35 lbs. Delivers all necessary power for the SCR-522 transmitter & receiver. Can be operated from 28 V. DC or coupled to gas engine or electric motor mechanically **\$4.95**



BC-314 RECEIVER

Frequency coverage 150-1500 Kc. in 4 ranges. Two RF stages, 1st detector, two IF stages, second detector, RF oscillator, CW oscillator and audio. Total, 9 tubes. 14 V. DC at 5.3 amps. input to dynamotor. Easily converted for 110 V. AC. Use headphones or speaker or both. New, with manual **\$89.50**
Used **\$69.50**

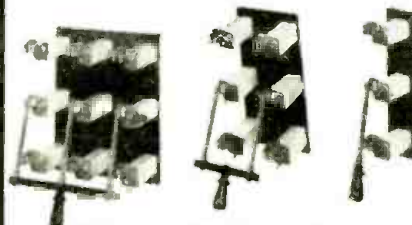

ANTENNA KNIFE SWITCH

Has 2 1/2" porcelain insulator bakelite base, heavy blades 4" long. Single Pole Double Throw **\$.75**
Double Pole Double Throw **1.00**
Triple Pole Double Throw **1.25**

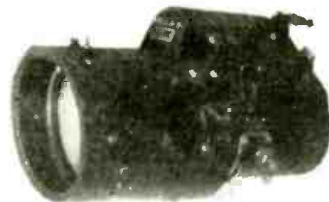

INDICATOR SCOPE ID-41/APQ-13

About 6" diameter by 15" deep. Contains 1-5FP7, 1-6AK5 tube, 5 Grain of Wheat 3 V. pilot lights, magnetic deflection yoke, condensers, resistors, potentiometers, sockets. **\$6.95**

WILLARD LEAD ACID CELLS



6 V. (New) (Dry-charged) **\$3.00**
6 V. (In metal carrying case) (Add electrolyte specific gravity 1.265) (Drugstore) **\$4.00**

DYNAMIC HANDMIKE

High impedance type—with press-to-talk switch that shorts microphone when released and operates a relay or other circuit when depressed. Designed for close talking PA and mobile communications service. Speech is brisk and clear. Made to stand rough handling. Black wrinkle finished. Has 6 ft. 3 conductor shielded rubber covered cable and standard amphenol plug. Made by Electro-Voice for the Signal Corps. Comparable mikes **\$7.95** list at \$28.00. SPECIAL. EACH



Radio Co
130 W. New York St.
Indianapolis 4, Ind.

Unless Otherwise Stated, All of This Equipment Is Sold As Used
CASH REQUIRED WITH ALL ORDERS
Orders Shipped F.O.B. Collect

SLASHED PRICES DOWN

No. T-4640

TRANSFORMER



Here is a rugged transformer built to Army specs. Hermetically sealed with Franklin Terminals for easy soldering. Primary 115 v. 60 cys. Sec. No. 1 8.5 v. ct @ 58 ma. Sec. No. 2 5.4 v. @ 3 a. Sec. No. 3 6.4 v. @ 6 a.

Weight 10 lbs. Your cost **\$2.49**

No. T-406

MODULATION TRANSFORMER



Designed for an 807 final. 6L6 tubes as modulators, a small compact job to handle moderate power.

\$3.25

No. M4214

DYNAMIC MIKE



Has push to talk switch designed for the famous Mark II Transmitter, but can be used anywhere—A wonderful value—Black Bakelite Frame.

Complete with 3 ft. rubber cord and PL55 plug **\$1.75**

No. M-462

3 1/2 INCH "S" METER



Used in a Bridge Circuit, will give you accurate readings on your surplus receiver or receiver not equipped with meter. Uses light for lighting meter face.

\$4.95

No. D-4064

DYNAMOTOR

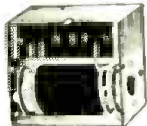

Used with the popular BC-312 Radio Receiver. 12 volts input—235 volts @ 90 ma. Output complete with filter mounted in can.

\$2.49

No. C-611

R.F. UNITS FROM THE BC-312

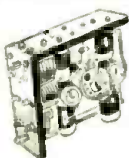

Contain six coils which cover from 1500 KC to 18 Mc. Has a ceramic band switch to change from any coil. Each coil is tuned with an air padder. Build your own receiver or signal generator with this assembly. A marvelous Buy at ...

\$1.98

No. H-100

WATERPROOF METAL BOX

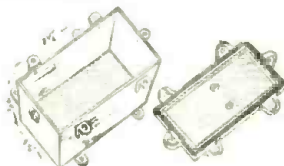

Easily opened. Completely sealed against moisture when closed. Large enough to use for tuning units outside at beam at any place where waterproofing is necessary. 4 1/2" high, 5 1/2" wide, 8 1/2" long ...

\$2.00

K I T S !

TUBE KITS

Complete Set of Tubes for SCR-522 **\$17.95**
 Complete Set of Tubes for BC-348 **\$7.95**
 Complete Set of Tubes for BC-312 **\$7.95**
 Specify Model Numbers

BC-348 Owners

CONVERTER FOR BROADCAST BAND

Convert that BC-348 without any alteration in your circuit. Our special converter takes power from receiver. Just tune your set to 450 kc. and forget it. All tuning is done on a converted panel covering 550 to 1600 kc.—double conversion means High Sensitivity, Excellent Fidelity and Higher Selectivity—complete basic kit with schematic and full instructions—less chassis dial and tuning knobs. Terrific Buy at..... **\$6.50**

Model 200-EA. 5-ELEMENT 2 METER BEAM KIT. Folded di-pole driven element. All-aluminum construction. Feed with low impedance coaxial cable. Amateur net price..... **\$8.40**

No. H-487



ANTENNA MOUNTING BASE

Here is a unit for mounting your mobile ant. on the car—made of heavy gauge steel with rubber housing enables your Ant. to take any kind of shock without breaking. Will handle 50 lbs. 16 feet long, 5/8" diam. **\$1.89**

No. M-248

2 1/2" 0-1 MIL MOVEMENT



Bakelite cased meter—27 ohms. Basic resistance may be used wherever a small 1 mil movement is needed—for S-Meter in receiver or basic meter in test equipment. A steal at..... **\$2.95**

DESIGNED FOR THE 522 TRANSMITTER

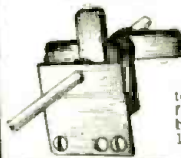

A Four Band Selector Unit Which replaces the selector motor allowing you to change frequency from the front panel quickly. Can be installed in 10 minutes **\$3.00 each**

No. 3-651

DI HEPTAL SCOPE SOCKET



Socket 14 pin for the new 10HP4 complete with leads. Designed for high voltage. A very popular item. **\$1.49**

No. H-3040

Here is a Buy—Dual Grinder

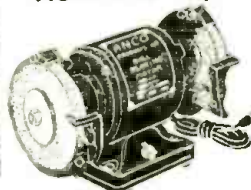

HEAVY DUTY

Using 1/3 horsepower motor—if you do any work around the house this will save you endless hours of labor.

\$36.50

No. S-3006

START STOP PUSH BUTTON



Designed for push starting or stopping of the transmitter. Fast operation of the rig. Stop button is red. Start button is black. Give your rig that professional appearance **\$1.25**

No. N-268

VIBRATOR POWER SUPPLY

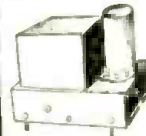

Made by Mallory. 12 volts input. Delivers 190 volts @ 85 ma. Perfect for mobile receivers. Lo-drain battery current. Made to rigid Army specifications. **\$3.50**

No. S-4611

HEAVY 8" P.M. SPEAKER



Will handle Power—7 oz. Alnico 3 Magnet. A wonderful buy. This speaker is designed with a flippable cone for faithfully reproducing the low frequencies. **\$3.89**

Only two to a customer.

No. R-4602

DUAL RELAY



2 110v 60 cy Relay Mounted on one frame. Both relays double pole. One single throw. One double throw. Coils can be paralleled or used independently.

\$2.20 each

No. B-4011

2 VOLT STORAGE BATTERY



Wonderful for mobile equipment. A rugged plastic case will allow you to use this battery without worrying about breakage—30 amp capacity balls on side tells when battery needs recharging. Size 5"x3"x4" **\$3.49**

No. T-6042

POWER TRANSFORMER



Heavy Duty 750 volts C.T. @ 250 ma. with a 130 volt bias tap—perfect for oscilloscope supply or any application needing these voltages. Size 5 1/2" high 5 1/2" wide 3" deep. Weight 21 lbs. **\$5.45**

No. F-604

NAVY FONES



Complete with 5 foot rubber cord. low impedance 600Ω. has a chin band which is adjustable—These phones are very sensitive and designed for rugged service. **\$1.75**



VIBRATORS in stock

Type A Standard 6 Prong Base Synchronous 6 volt. Type B. Same as above but designed for 110 v.

Either Type **\$1.09**

20% DEPOSIT WITH ORDERS UNLESS NOTED

NIAGARA RADIO SUPPLY CORP.

160 GREENWICH STREET

NEW YORK 6, N. Y.

ALL PRICES F. O. B., N. Y. C.



WANT YOUR FCC COMMERCIAL LICENSE IN A HURRY?

Use CIRE Training and Coaching Service—and Get Your “Ticket” in a Few Short Weeks!

Thousands of new jobs are opening up—FM, Television, Mobile Communication Systems. These are only a few of the radio fields which require licensed radio technicians and operators.

Get your license without delay. Let Cleveland Institute prepare you to pass FCC license examinations, and hold the jobs which a license entitles you to, with CIRE streamlined post-war methods of coaching and training.

Your FCC Ticket Is Recognized in ALL Radio Fields as Proof of Your Technical Ability

More than ever before an FCC Commercial Operator's License is a sure passport to many of the better paying jobs in this New World of Electronics.

Employers frequently give preference to the license holder, even though a license is not required for the job. Hold an FCC “ticket” and the job is yours!

Hundreds of Satisfied, Successful Students

“I have taken the first class Phone license examination and received my first class ticket last Saturday, May 31. In closing I must say yours is an excellent radio course, and I really appreciate your help and the fine service you have rendered me.”
Student # 2876N12

“I passed the FCC examination in radio-telephone 2nd class, at Detroit on June 3rd, and I want to thank you for your ready assistance as my instructor on Section 1 of Nilson's Master Course.”
Student # 2799N12

“I have had my 1st class radio-telephone license since March of this year, and plan to continue with your course since I find it a great help in studying transmitters.”
Student # 2779N12

“After sending in Lesson E-9 I took the commercial operator's license examination for 2nd class radiotelephone, and passed O.K. I received the license last week.”
Student # 2772N1



I can show YOU HOW TO PASS FCC COMMERCIAL RADIO OPERATOR'S EXAMS

If you've had any practical radio experience—amateur, Army, Navy, radio servicing or other, my time proven plan can help you, too, on the road to success. Fill out the coupon below and mail it. I'll send you, FREE, the entire story.

Edw. H. Guilford
Vice President

CIRE training and coaching makes it EASY to get your FCC ticket EVEN WITH THE NEW EXAM



BULLETIN

FCC adds FM and television to the First Class License Exam. Effective July 1, 1948, to get a First Class ticket, you will be examined in Frequency Modulation and Television, too.

CLEVELAND INSTITUTE OF RADIO ELECTRONICS
RC-6 Terminal Tower, Cleveland 13, Ohio

I want to know how I can get my FCC ticket in a few short weeks. Send me your FREE booklet, "How to Pass FCC License Examinations" (does not cover exams for Amateur License) as well as a sample FCC-type exam and Catalog A, describing opportunities in Radio-Electronics.

NAME

ADDRESS

CITY ZONE STATE

Veterans check for enrollment under G.I. Bill
NO OBLIGATION — NO SALESMEN

12 BOOKS IN 1

IN THE

RADIO DATA BOOK

The only Radio Handbook of its kind! . . . 1148 pages, 12 sections, each a complete coverage of one radio subject.

Together, the 12 sections form the most complete Radio Handbook you can BUY! Easy to read . . . A quick reference!

Plan every operation in radio and electronics with the Radio Data Book. This new radio bible will be your lifelong tool . . . you will use it every day, on the board, at the bench, in the field! Use it for engineering, construction, trouble-shooting and testing. The RADIO DATA BOOK will be your invaluable aid in design, experiment and in layout. It will help make your production better, faster and easier. In any and every operation in radio and electronics, you will use the RADIO DATA BOOK!

The RADIO DATA BOOK is a work of complete authority, prepared by engineers with many years of practical experience. They have been assisted by the Boland & Boyce staff of editors skilled in preparing electronics manuals for the U. S. Signal Corps for many years. These men have worked for several years gathering material for this book . . . all the knowledge of radio principles and operation . . . all the statistics . . . all the newest developments in electronics . . . every possible angle and detail. Eighteen months were spent digesting this material into the most concise, the clearest, and the most readable form. The result is this invaluable manual . . . The RADIO DATA BOOK. Whether you use this book for general reference, for scientific instruction, or for education, one thing is certain—the practical help, the daily usefulness you will derive from it will prove to be worth many, many times its astonishingly low price!

Here's a description of just ONE section—Section 5, Sound Systems:

This section covers the planning, selection of components, and assembly of complete P.A. installations. Every type of unit and material used in a sound system is described and analyzed. Components are classed as to size and type of P.A. installations in which they should be used. Tables and charts are given from which to determine power and ratings. Microphone and speaker construction are described and illustrated in detail . . . placement in auditoriums, etc., for proper acoustical results is explained and illustrated. Patterns of the different types of microphones are illustrated as are the proper methods of wiring up the various units, etc.

The above is just one of the twelve big sections in the RADIO DATA BOOK. We wish we had room here to describe all twelve in detail, but just look over the list of sections, and you will see why this is the best radio handbook money can buy. Send in your order for the RADIO DATA BOOK today!

Coming Soon!

The VIDEO HANDBOOK

Everything in Television in one Complete Textbook.
Over 500 pages completely illustrated.

This new handbook will be invaluable to everyone concerned with the technical aspect of Television. Everything from the basic theory of television through the design and characteristics of receivers to final installation, operation, and maintenance is covered. This is a completely new book that includes all of the latest developments in the field—the components discussed are of the newest design—the practical maintenance described is a result of intensive study of the equipment placed in operation during the past few months.

There are five completely illustrated sections in the VIDEO HANDBOOK, each over a hundred pages long. Each section completely covers.

The VIDEO HANDBOOK will be out October 15th, but we have received a flood of orders already. To insure your getting a copy in the first printing—mail your order now.

The VIDEO HANDBOOK is \$5.00 alone, or you can order it with the RADIO DATA BOOK and get both books at the special price of \$9.00. Send in the coupon today!

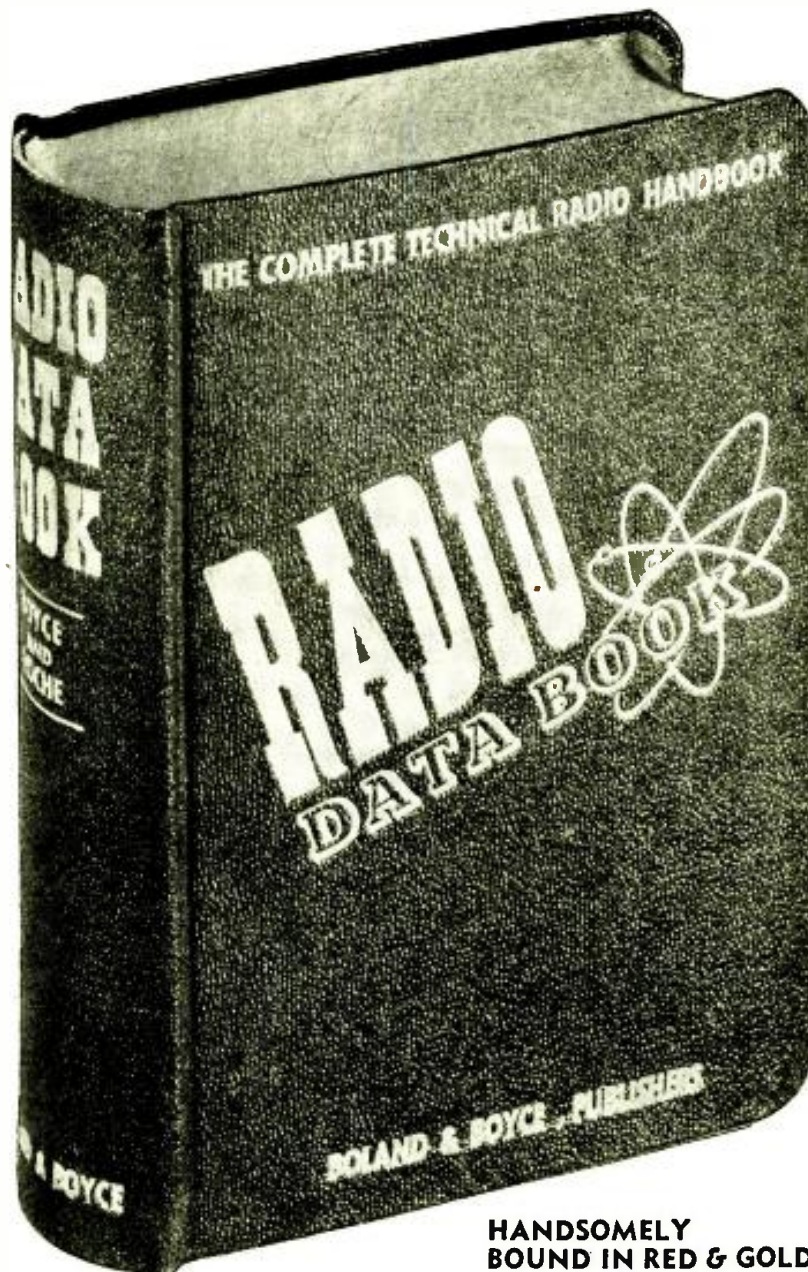

**HANDSOMELY
BOUND IN RED & GOLD**

12 sections . . . 1148 pages . . . Completely Illustrated

- SECTION 1. THE 150 BASIC CIRCUITS IN RADIO.
- SECTION 2. COMPLETE TEST EQUIPMENT DATA.
- SECTION 3. TESTING, MEASURING AND ALIGNMENT.
- SECTION 4. ALL ABOUT ANTENNAS.
- SECTION 5. SOUND SYSTEMS.
- SECTION 6. RECORDING.
- SECTION 7. COMPLETE TUBE MANUAL.
- SECTION 8. CHARTS, GRAPHS AND CURVES.
- SECTION 9. CODES, SYMBOLS AND STANDARDS.
- SECTION 10. 50 TESTED CIRCUITS DESIGNED FOR OPTIMUM PERFORMANCE.
- SECTION 11. DICTIONARY OF RADIO AND ELECTRONIC TERMS.
- SECTION 12. RADIO BOOK BIBLIOGRAPHY.

12 complete books in one only \$5.00

Less than 42c per book!

Mail this coupon to your jobber—or direct to:

RC-6

BOLAND & BOYCE, INC., PUBLISHERS
460 Bloomfield Ave., Montclair, N. J.

Please send me:

- The Radio Data Book at \$5.00.
- The Video Handbook at \$5.00.
- Both Books at the Special price of \$9.00.

- I enclose full payment.
- I enclose \$1.00 and will pay balance to postman on delivery.

NAME

ADDRESS

CITY ZONE.....

STATE

BOLAND & BOYCE, INC., PUBLISHERS

RADIO-CRAFT for

THE RISING TIDE OF FM

FM, in the midst of its boom, still rises rapidly.

By HUGO GERNSBACK

IN the middle of April, when this was written, there were in actual operation in the U.S. 463 FM broadcasting stations. In addition the Federal Communications Commission has authorized 564 more FM stations which are as yet not on the air. Besides the above, 88 more applications are pending. As soon as the latter are in operation, we will therefore have 1,115 FM broadcast stations in the U. S. This does not by any means represent the saturation point. Conceivably between 3,000 and 4,000 FM stations can operate successfully in continental U.S. without undue overcrowding.

Why so many stations? The reason of course is that the effective transmitting radius of an FM station is its optical horizon—in flat country from 25 to 35 miles, in hilly or mountainous regions from 35 to 100 miles. The topography in the U.S. being preponderantly level, it follows that over 85% of the FM stations will have an effective transmitting range of only an average of 35 miles radius. Hence many more transmitters are needed to cover the entire country.

The present trend indicates that in a foreseeable time the U.S. will undoubtedly be converted from AM to FM. The reason is simple: once a radio set buyer has listened to the much clearer, practically noiseless and staticless radio reception of an FM receiver, he will shy away from AM. This is indeed what is now happening all over the U.S. It also explains the present FM boom, both in transmitters being erected and receivers sold.

Here are the latest FM receiver statistics: There are now in use (up to April 30) 2,022,547 FM receivers, which figure includes FM tuners (converters) and AM-FM sets. Radio manufacturers are producing now about 148,000 FM units monthly. These figures are compiled from RMA and independent sources.

At one time it was thought that FM would be a completely independent adjunct to radio broadcasting in America. It was felt then that every FM station would disseminate its own programs, or that there would be a country-wide high-fidelity FM network which would actively compete with AM stations and AM networks. This did not come about, although there are of course many independent FM stations which originate their own programs—mostly phonograph music at pres-

ent—and one or two high-fidelity regional FM networks.

Instead of strictly independent FM programs, the present trend is unmistakably toward a solid duplication of those broadcast by the AM stations. More and more do AM broadcast station owners invest in FM transmitters. And as soon as they do so they now invariably duplicate the programs which are broadcast by their AM transmitters over their FM transmitters as well, even though this means sacrificing high-fidelity transmission to ordinary network standards (100-5,000 cycles).

Moreover, the exigencies of economics will make it necessary for the independent small-town FM transmitters to take the high-grade, sponsored AM network programs originating in New York and Hollywood. This is but a repetition of broadcasting history when early independent small-city AM broadcasters found it necessary to become affiliated with the big radio networks.

The reason for such affiliation is a purely economic factor: no small-center independent FM station can possibly afford to pay for a continuous stream of high-class programs. Besides, the American public has been educated to the big-feature, big-star radio programs. If the FM stations do not broadcast these features, then FM would be doomed to failure. Clearly this will not come about, and the present tendency supports this view.

That the public's listening trend is unmistakably toward FM is clearly shown by the radio receiver manufacturers. There is first of all a huge output of pure FM radios.

Next we have an even higher output (at present) of FM tuners that can be attached to old-style AM receivers to bring in FM programs. Then, we have combination AM receivers with FM, to bring in both types of programs. Finally all the newer and better television sets are also equipped for FM, making reception much more pleasurable.

How long will it be till the entire U.S. broadcasting facilities have been completely converted to FM? From about 8-10 years might be a conservative estimate for 85% to 90% of our transmitters. But from 10% to 15% of them may remain AM for much longer—in fact some of the larger stations may continue to transmit AM indefinitely.

**This Special FM Issue
is Dedicated to
Major
Edwin H. Armstrong
Father of FM**

RADIO-CRAFT is happy and proud to dedicate this special number on FM radio, to Major Edwin H. Armstrong—scientist, radio engineer and inventor extraordinary.

Few radiomen in U.S. history have achieved the towering stature of Armstrong. His unprecedented and epoch-making basic discoveries: the superheterodyne, superregeneration, and frequency modulation will forever make him one of Radio's Great Immortals.

Armstrong, who is professor of electrical engineering at Columbia University, is now in the prime of his eventful and productive life. Let us wish him a long and healthful future, in the full knowledge that he will bestow more of his priceless gifts on radio and all of us.

RELIABLE FM RANGES may extend far beyond the horizon, K. A. Norton of the Bureau of Standards reported last month. Experimental research undertaken by the Bureau has shown that atmospheric "ducts" and boundary layers in the lower troposphere both reduce the attenuation of high-frequency radio waves with distance at points beyond the line of sight. These results are expected to provide a firmer basis for the prediction of the service and interference ranges of FM broadcasting stations; they should also aid in the solution of problems that may occur in connection with other uses of the spectrum above 30 megacycles.

Variations in the density of the atmosphere within a few hundred feet of the ground provide differences of refractive index which can increase the curvature of a radio wave by an amount equal to or greater than the curvature of the earth. Known as *ducts*, these characteristic changes in the refractive index of the air near the surface of the earth become more and more effective in bending radio waves as frequency increases.

For the overland propagation paths which are usually involved in frequency modulation broadcasting, effective atmospheric ducts are to be expected after the sun sets and the earth begins to cool the atmosphere. Under favorable circumstances this cooling may continue throughout the night with the formation of a duct of great width. The received fields would then be expected to reach their peak values early in the morning before the sun has had opportunity to destroy the duct by warming the earth.

This general behavior has been observed for the fields of FM broadcast station WCOD at Richmond, Virginia, as received at the National Bureau of Standards in Washington, D. C. On August 4, 1947, for example, the station began broadcasting about 6:25 in the morning. Throughout the day the fields gradually increased until a little after midnight. At this time the received field increased markedly, and the fading, which had occurred at a fairly rapid rate during the day, decreased both in amplitude and frequency of occurrence. The calculated field intensity corresponding to propagation in a vacuum over a flat earth was exceeded for the half hour just prior to 1 am, when the station went off the air. Presumably this favorable propagation condition lasted throughout the night since the fields

were again very strong on the following morning when the station began broadcasting at 6:25 am. The mechanism responsible for the strength of these fields and for the comparative absence of fading is considered to be atmospheric refraction.

From analysis of the field-intensity data obtained by the Bureau, it appears that external receiving antennas may be used with considerable advantage for reception of FM broadcasts at points far beyond the horizon of the transmitting antenna. The FM fields from stations at large distances may be expected to reach their maximum levels in the early morning hours during the summer months; at these times effective ranges up to several hundred miles may be expected.

AUTOMATIC CODING and decoding of confidential information is now possible with a new magnetic recording system, the Codit Company of Chattanooga, Tennessee, announced last month.



Magnetic disc machine codes as it records.

The system consists of a specially coded plastic tracking disc. The disc is placed over a paper or plastic record on a turntable, and the grooves in it act as a guide for the needle which controls the movement of the special recording arm. As the arm moves across the surface of the record, it records the voice magnetically on the iron-oxide-coated surface.

The magnetic pattern cannot be understood or analyzed without the use of an identical tracking disc during playback. Since each purchaser receives a set of identical discs, and no other discs are made to the same pattern, he has his own private code which cannot be deciphered.

FACSIMILE NEWSPAPERS will soon be broadcast in rural areas if a plan suggested by William G. Finch of

Finch Telecommunications, Inc., is approved by the FCC. Mr. Finch is now negotiating for the construction of six FM stations in northern New York, with the idea of using them in a facsimile network as well as for FM broadcasts.

These facsimile papers would furnish farmers with a permanent record of livestock prices, weather reports and farming tips, as well as news flashes and pictures. Such a service would also provide a big market for rural advertising.

TWO-WAY RADIO for funerals is planned by the Catholic archdiocese of Chicago. An application filed with the FCC last month to set up a permanent land station and two mobile field units at Mt. Carmel cemetery near Chicago.

Radio communication among cemetery workers would eliminate confusion when several funerals are handled, according to the petition submitted by the Rev. William P. Casey, cemeteries director.

A PAGING RADIO little bigger than a package of cigarettes may solve the problem of reaching doctors or business men in theaters or city streets, it was revealed last month.

According to Sherman Amsden, president of Telanserphone, Inc., New York, the little receivers would be tuned to the frequency of a special transmitting station. Each subscriber would receive an identifying number (his own private station call). Telanserphone, which is a telephone-answering service, would receive important messages and immediately start broadcasting the subscriber's call. The subscriber need switch his radio on for only a few moments to listen through the list of calls being broadcast. If his is among them, he telephones to the service and receives his message.



Receiver is practically cigarette-pack size.

With this system, a single set of batteries should last three months, according to the designer, Richard Florac of New York City. No entertainment which would tempt the user to run the radio for long periods will be broadcast—only paging calls, weather reports and emergency news.

RADIO-CRAFT for

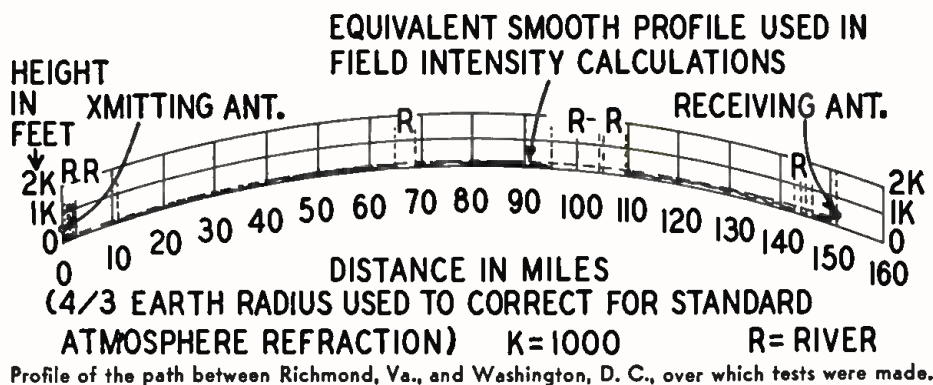

MACHINES THAT LEARN were reported last month by the Philips Lamp Works of Eindhoven, Holland. The machine in question is an electronic telephone switching apparatus of great complexity, similar to a computing machine.

Usual switching equipment goes through the same blind search until the dialed number is located and the call put through. But this machine learns to distinguish frequently-called numbers, and when a number is called often, it can make the connection more rapidly. It makes "intelligent" short-cuts.

The invention, it is stated, can be applied to mathematicians' electronic computers. In a factory where machinery is run by control apparatus, it would speed the most common operations. And if new jobs were developed, the machine might learn those, too!

PASTEURIZATION BY RADIO takes less than one second, the Radio Corporation of America reported last month. In the process, the bacterial count of milk drops from 50,000 to 100, an unusually low figure. The milk is homogenized at the same time by the action of the rapidly fluctuating electric field on the tiny oil droplets suspended in the milk.

RADIO-ELECTROCUTION

Readers—especially radio technicians—will do well to read the item below with extreme care. A household radio can be dangerous! This is the second report of a double electrocution in the bathtub due to a midget radio. The other one was that of a mother and three-year-old child. The child caught the line cord and pulled the radio into the tub. It is the duty of radio servicemen to point out to customers potential dangers in (especially) midget a.c.-d.c. radios. If a radio is used in the bathroom, it must be permanently installed—bolted firmly to a shelf at a distance from the tub or wash-bowl. The same precautions are necessary with kitchen radios. A set near the sink can be as deadly as one near the bathtub!

A small radio caused the death by electrocution last month of two small girls in Binghamton, New York. The girls, Wanda Thompson, 12, and Marlene Monell, 11, were killed in the bathtub when the radio to which they were listening fell into the tub. The 117-volt current was sufficient to cause instant death under the circumstances, the coroner reported.

Investigators reported that Marlene had often taken the radio into the bathroom, set it on the tub and listened to programs during her evening bath.

Ironically, the father is an electrical-appliance repairman. He was called out on an emergency refrigerator job during the evening and was not at home at the time of the accident.

THEATER TELEVISION using the delayed technique was presented for the first time in a sneak preview at the Paramount Theater in New York City last month.

The broadcast consisted of two amateur boxing bouts. It was sent by 7,000 megacycle microwave relay from the arena to the top of the *Daily News* Building and from there again relayed to the top of the theater building.

At the theater, the telecast was transposed almost instantaneously onto 35-millimeter film by a special recorder, and the film was projected through the standard 35-millimeter projector. Only 66 seconds elapsed from the time a scene was telecast to the time it appeared on the screen. In the strict sense this is not television, but rather *delayed* video.

LICENSING for New York City's radio technicians will remain a dead issue till next Fall at least, city councilman Stanley Isaacs promised last month. This, said the originator of the measure to license radio repairmen, is to "give the industry a chance to clean up its own problem."

Reason for the respite is the encouraging progress being made by the Associated Radio Servicemen of New York (City). The ARSNY has formed grievance committees to handle customer complaints against any radio repairmen, whether Association members or not, is now sponsoring a course of technical lectures, and is planning to co-operate in organizing for New York City a Town Meeting of Radio Technicians (similar to the Philadelphia meeting) late this summer.

TELEVISION may not reach "a good share" of the population of this country, Joseph H. Ream, executive vice-president of the Columbia Broadcasting System, declared last month. Rural sections, he continued, will be beyond the service range of television stations, and that "very probably" smaller cities and towns may never be able to support stations.

CANADIAN FM LICENSES now number 44, it was stated last month in reply to a question in the Canadian Parliament. At least 11 stations are in active operation. These FM stations are located in four provinces, from New Brunswick to British Columbia, and range in power from 250 to 3,000 watts.

In addition to the stations already licensed, at least four more applications have been received.

Of the stations now in active experimental operation, five are under the Canadian Broadcasting Corporation. The remainder are privately owned. While definite frequency assignments have not yet been made the stations now operating are all working on frequencies between 93 and 106 mc, and it is expected that the Canadian FM band will approximate that now authorized for United States FM broadcasting stations.

AUTHORIZED DEALERS who are discovered reducing list prices on fixed-price television receivers have been dropped by the Allen B. DuMont Laboratories, Inc., Victor E. Olson, receiver sales manager, revealed last month. He also disclosed that the company has discontinued franchises of dealers who have transhipped merchandise to non-authorized stores.

A shopping agency has been engaged to watch retailer activities in states which have fair trade laws.

FM TRANSPORT RADIO has been installed on 250 Greyhound buses operating midwest routes, Motorola announced last month. This system permits bus dispatchers to keep in constant communication with all buses and terminals in the network. The transmitters and receivers are housed in a special compartment at the rear of the bus (see photo below).

The busses also have a small speaker built into the headrest of each passenger's seat. An individually operated switch gives the passenger a choice of either one of two radio programs.

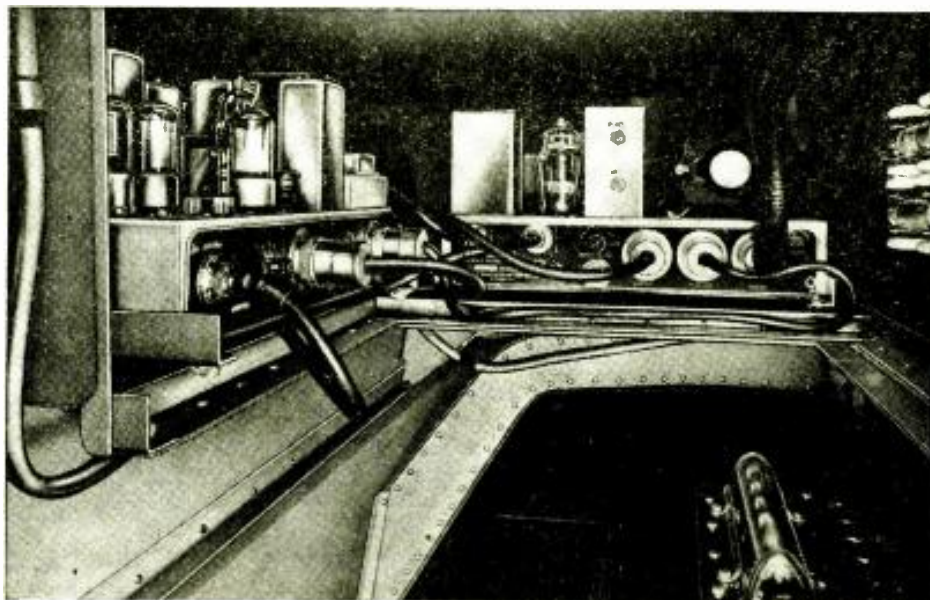

This bus installation provides communication for the driver and programs for passengers.

Frequency Modulation— 1922 and 1948



Courtesy of Fortune Magazine; photo by Eric Schaal
Armstrong revisits the Yonkers room, scene of his early work.

Rodio Broodcasting—1922—(Looking Bockword)

IN the year 1922, when broadcasting was just getting under way, amplitude modulation was the method employed. Nobody called it amplitude modulation, because most people didn't know there was any other kind. To them it was simply "modulation."

Nonetheless, the idea of varying the wave length of the signal, or its frequency, could be found in the text books more than fifteen years before broadcasting started. As a practical reality, however, it was still an idea and all attempts to make use of the method had resulted in failure.

In the nineteen-twenties, the characteristics of the wave resulting from modulating the frequency were examined by some very able mathematical physicists. The consensus was summed up in a conclusion appearing in a paper in the *Proceedings of the Institute of Radio Engineers* in 1922 in the words:

"Consequently this method of modulation (frequency modulation) inherently distorts without any compensating advantages whatsoever."

So amplitude modulation became enthroned as the accepted method of doing the job.

Now many of the readers of this article remember the great amount of effort that was put forth in the nineteen-twenties, or earlier, to discover or invent a "static eliminator". They will also remember that the people who put any great amount of emphasis on, or expressed any great amount of hope in, the possible solution of the problem, were considered rather visionary—a bit "queer", in fact.

In 1928, again in the *Proceedings of the Institute of Radio Engineers*, we find the consensus of the art at that time in a mathematical demonstration of the fact that

". . . static, like the poor, will always be with us."

So it appeared in the early nineteen-twenties that the broadcasting art was destined to be forever limited by the vagaries of the forces of nature and the imperfections of the amplitude modulation system, wherein a "radio" sounds like a "radio" and not like a musical instrument.

Rodio Broodcasting—1948—(Looking Forward)

But as everyone now knows, those pronouncements turned out to be false prophecies. Some discoveries were made, and what were regarded as axioms in the art had to be rewritten.

1922 and 1948

Edwin H. Armstrong

The system now popularly known as FM operates with less than one-tenth of the distortion of the best AM system, and improvement in this direction is not yet at an end. A new era of realism in the transmission of music with all its tones and dynamic range has become a practical possibility. As everyone also knows, the problem of static, both natural and man-made, has ceased to be a problem. FM reduces noise to 1/100th of its energy on an AM signal on the same frequency, and since the system operates in the very high frequency ranges, still further immunity from atmospheric static is obtained.

It is clear, therefore, that the inventing and engineering responsibilities of those men who worked to bring about this new era in broadcasting have been successfully met and their duties successfully discharged. Their work is done.

The question now is squarely raised: Will the public get the benefits of this work to which it is most certainly entitled, since in the end it pays the bill? The responsibility to see that it does no longer rests with the inventors and those who have engaged in the creative engineering that brought FM into being. It rests upon the administrative governmental bodies, upon the broadcaster, and most heavily

(Continued on page 55)

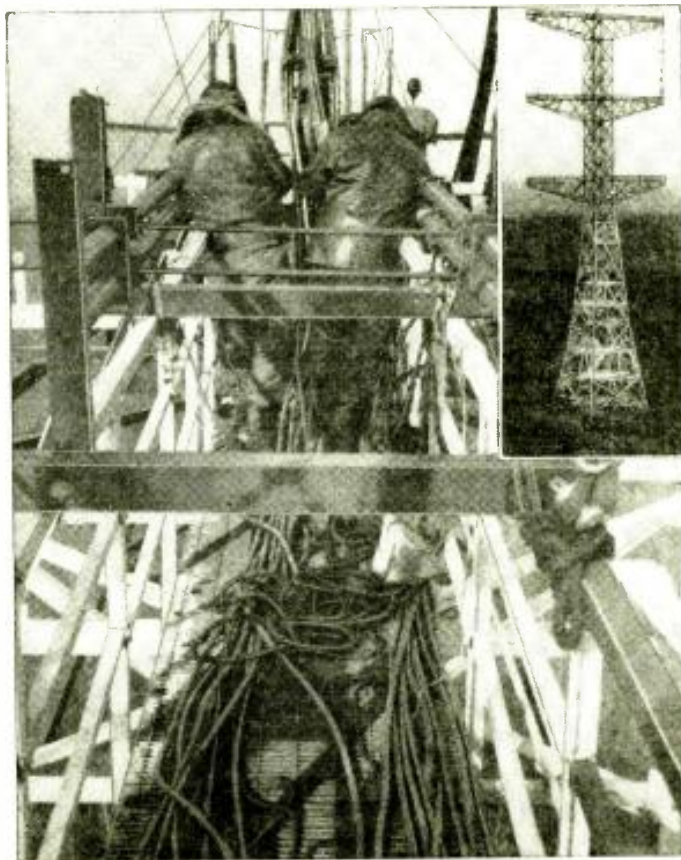

Men working on an arm of the pioneer FM antenna at Alpine, N. J.

FM Fundamentals

Why FM radio is free from many of the drawbacks of AM broadcasting

By JOHN B. LEDBETTER

FREQUENCY modulation is not new. Since the early days of broadcasting various attempts have been made to utilize some form of FM as a means of overcoming radio disturbances and other disadvantages of AM broadcasting. Early attempts were unsuccessful because any advantages gained by use of FM were lost in the receiver, and because a frequency-modulated signal produced less than one-tenth the power of an amplitude-modulated signal. It remained for Major Edwin H. Armstrong, professor of electronics at Columbia University and inventor of the superheterodyne and superregenerative circuits, to develop and introduce the system which is the basis of present-day FM.

Advantages of frequency modulation over amplitude-modulated systems include 1. immunity to static and man-made noises, 2. freedom from fading and interference, and 3. high-fidelity reproduction. Other gains are greater efficiency and economy of transmitter operation, increased service area, and lower-power requirements.

Noise can generally be classified as being either impulse or random. Impulse noise contains bursts or pulses which occur at separate or infrequent intervals. This type is produced by electric razors, ignition systems, power lines, and other electrical equipment. Random noise pulses overlap or run together to form a continuous sound. Examples of random noise are thermal agitation and tube hiss, both disturbances which originate in the receiver. Atmospheric disturbances and precipitation static are similar to random noise.

When this noise is received by an AM receiver, it is detected and amplified along with the desired signal. Such noise—or even an interfering AM station—can be objectionable even though its intensity is only 1% that of the desired signal.

When such noise is picked up by an FM receiver, it passes through the converter and mixer stages just as in an AM set. The FM detector, however, is designed to detect only variations in frequency of the applied signal, not changes in amplitude. Two methods are common. In the Foster-Seeley discriminator circuit, one or two limiter tubes precede the detector. These are i.f. stages which operate at low plate and usually zero grid voltages. As a result, their output cannot exceed a certain amplitude, and, if they receive a reasonably strong signal, the output amplitude is uniform at the maximum of which the limiter is capable. This uni-



Author checks frequency on built-in scope at WCTS, Cincinnati. Motor control is above hand.

form output carries all the frequency deviations of the original signal faithfully. Applied to the discriminator, these variations produce an audio output which varies in amplitude.

The *ratio detector* uses no limiters, but operates by distinguishing between the ratio of signal strength above and below the mean carrier frequency. Since this ratio varies according to the modulation in the frequency-modulated wave, but remains constant or nearly so in noise and amplitude-modulated signals, only the frequency modulation affects the output.

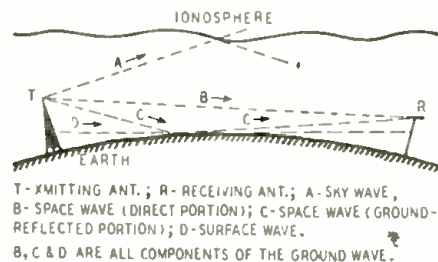

Fig. 1—Wave propagation at FM frequencies.

Thus one of the worst enemies of good reception is defeated at the start. Certain types of noise which are actually frequency-modulated do get through to the audio output, but these are rare and almost negligible.

As pointed out in another article in

this issue, another weakness of present-day broadcasting is the interference—complicated by fading—which ruins reception at night in large sections of the country.

Fading and interference

Radio waves consist of two components, the sky wave and the ground wave (Fig. 1). The sky wave is emitted skyward from the antenna and reflected back to earth at distant points by the ionosphere. The ground wave travels along the surface of the earth. The ground wave proper may be subdivided into two parts, the *surface wave* and the *space wave*. It is the surface wave which determines the daytime coverage of AM broadcast stations. At night broadcast frequencies may be transmitted long distances by the sky wave. The result is that the AM signal is reflected at a number of different angles, and appears at a number of different distant points. Many times the interfering station is located thousands of miles from the point of interference.

FM owes its freedom from fading and station interference to the fact that at high- and ultra-high frequencies, the sky wave is generally not reflected back to earth by the ionosphere, but continues out into space in practically a straight

(Continued on page 53)

FM RECEIVERS

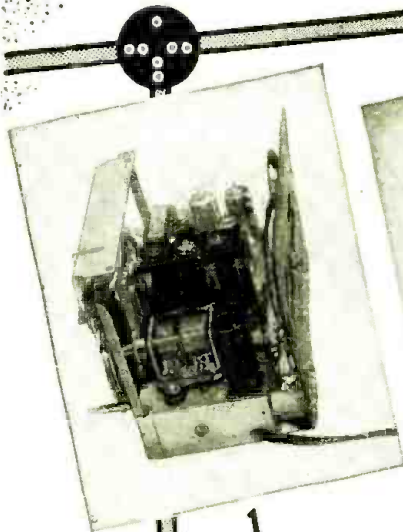

1

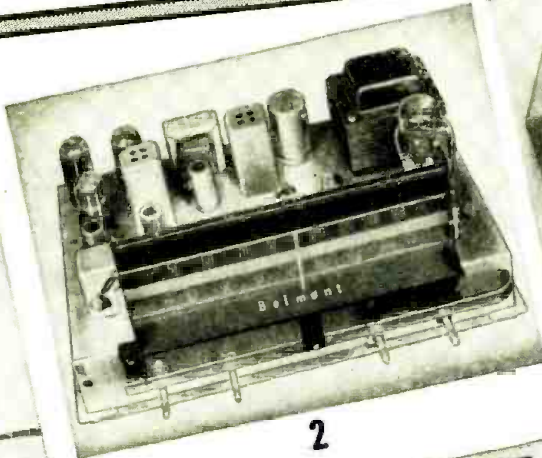

2

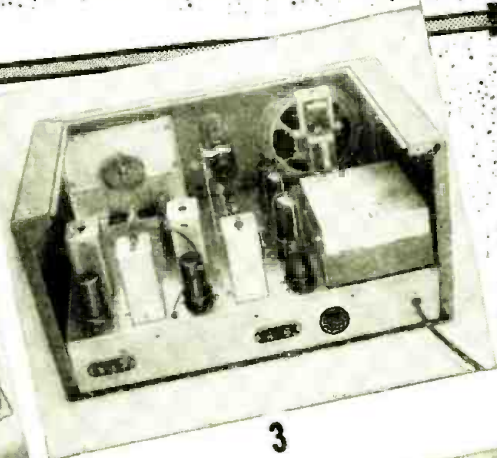

3

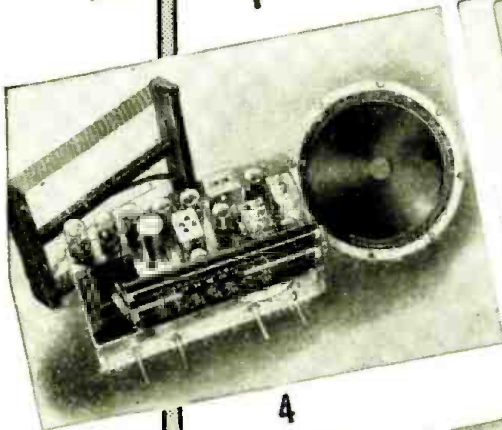

4

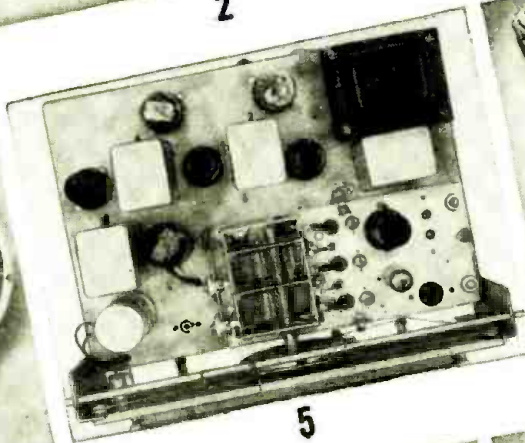

5

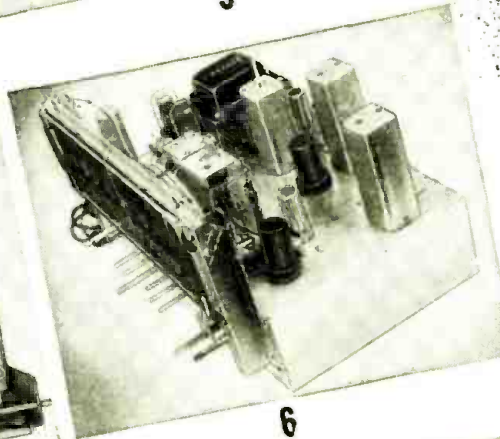

6

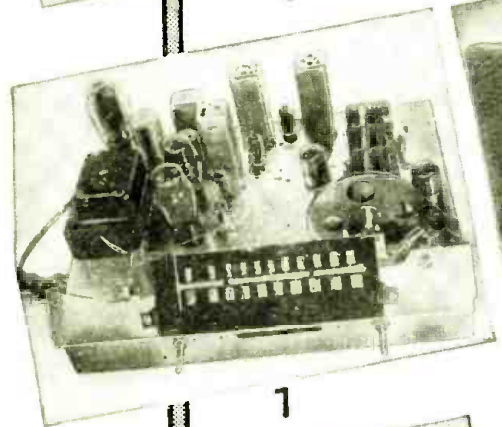

7

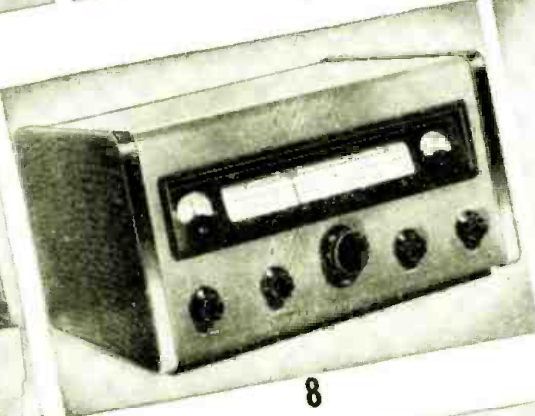

8

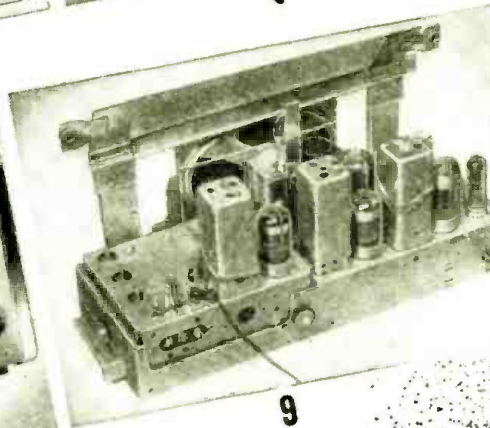

9

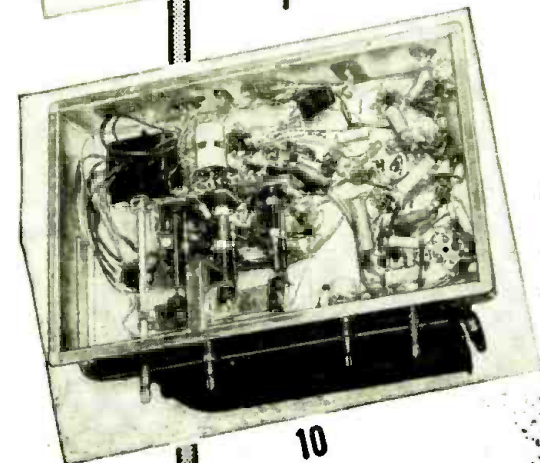

10

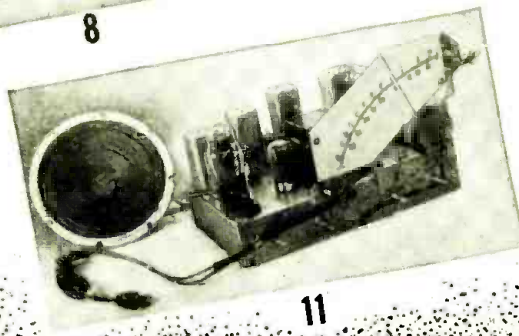

11

1—The coaxial tuner is shown behind the tuning condenser of the Motorola 77XM. 2—This Belmont Model 11AF21 has 11 tubes and uses a quarter-wave indoor FM antenna. 3—Rear view of the National NC-108T. The receptacle is for power to a.f. amplifier. 4—Espy-7B. This chassis and speaker are available for custom-built installations. 5—Capacitors tune FM and AM r.f. sections in the Farnsworth GK-084 to GK-087 sets. 6—Stewart-Warner A92CR3 to A92DR6. The FM and AM permeability tuners are ganged. 7—This 11-tube chassis is used in the Westinghouse Models H-164, H-166 and H-167. 8—The REL 646 is a commercial type set with field-strength and tuning indicators. 9—The r.f. sub-chassis of this Philco Model 48-472 is shock-mounted with rubber. 10—Under chassis of the Belmont Model 11AF21 shown in the center of top row. 11—Chassis of Westinghouse Models H-161 and H-168. Note the novel dial arrangement.

FM receivers, fundamentally alike, vary in many details and use components unknown to older radio sets

FM broadcasting has mushroomed from an entertaining curio into a full-grown industry in a comparatively few months. Set manufacturers, spurred by the ever-increasing number of FM broadcasting stations, are now breaking records for producing FM receiving equipment. There are a few straight FM receivers on the market but most manufacturers are producing sets for receiving both FM and AM broadcast stations.

The prospective purchaser of an FM set often finds very little technical information available on any set he may consider. This article and the data in the accompanying table may supply some of the lacking information, as well as give a brief review of the main features of the more common receivers.

The typical FM receiver consists of a mixer-oscillator (sometimes preceded

by an r.f. stage) one or more i.f. amplifiers, one or more limiters (in some types of circuits) a discriminator, an a.f. amplifier and a power supply. All sets are designed along these lines, but a number of them have outstanding differences due to different engineering approaches to identical problems.

Differences in discriminators

The ratio and Foster-Seeley discriminators are the most popular types in use today. The latter type normally requires one or two limiters following the i.f. amplifiers. These add to the size and over-all cost of the finished product. The ratio discriminator does not require limiters. Cheaper and more compact sets can therefore be made with this circuit. (FM detectors are discussed in another article in this issue.)

The locked-in oscillator discriminator

used by Philco, differs from both common types. The circuit of this section is shown in Fig. 1. It is designed around the FM 1000 tube, the No. 1 and 2 grids of which are connected in a modified Colpitts oscillator circuit tuned to the 9.1-mc i.f. with L1 and C1-C2. The

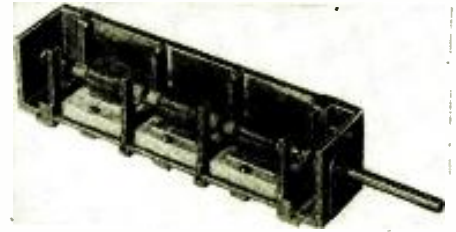

The Ware Inductuner, described on page 24, oscillator circuit is coupled to the plate through the electron stream. The plate coil L2 is also tuned to 9.1 mc. Its bandwidth is increased to about five times the width of the FM signal by the 5,600-ohm swamping resistor across it. The signal from the third i.f. amplifier is fed into the No. 3 grid. The coupling between circuits causes the oscillator to

(Continued on following page)

OUTSTANDING CHARACTERISTICS OF THE BEST-KNOWN FM RECEIVERS

Manufacturer and Model No.	Tuning Range	No. of Tubes	Tubes in Use FM/AM	Tuning System FM/AM	R. F. Amplifier FM/AM	FM Discriminator	Built-in Ant. FM/AM	A. F. Amplifier	Loudspeaker	Rectifier	Line Operation	Accessories	Tube Complement
ADMIRAL 7C64 (Ch. 8B1)	FM-AM	8	8/7	P P	1 FM 1 AM	Ratio	Fold. d'ple Loop	S-E	10" PM	5Y3	A.C.	Changer	6SB7-Y, 6AU6, 6AL5, 6SJ7, 6V6, (2) 6BA6
ADMIRAL 7C73 (Ch. 9A1)	FM-AM	9	9/7	P P	2 FM ¹ 1 AM ²	Ratio	Fold. d'ple Loop	S-E	12" PM	5Y3	A.C.	Changer	6SB7-Y, 6AL5, 6V6, 6SJ7, (4) 6BA6
ADMIRAL 9B14 to 9B16 (Ch. 9B1)	FM-AM	9	9/7	P C	2 FM ¹ 1 AM ²	Ratio	Fold. d'ple Loop	S-E	12" PM	5U4G	A.C.	Changer	6SB7-Y, 6AL5, 6SQ7, 6V6, (4) 6BA6
AIRLINE (WARDS) 74BR-1812	FM-AM	9	9/6	C C	None None	Ratio	1/4-wave Hank Loop	S-E	6" x 9" oval ED	5Y3	A.C.	Phono Input	6C4, 6AT6, 6V6, 6AL5, (4) 6BA6
AIRLINE 74BR-2702	FM-AM	9	9/6	C C	None None	Ratio	1/4-wave Hank Loop	S-E	10" ED	5Y3	A.C.	Changer	6C4, 6AT6, 6V6, 6AL5, (4) 6BA6
AIRLINE 74WG-2705	FM-AM ³	10	9/6	C C	1 FM None	Ratio	Loop Loop	S-E	10" ED	5Y3	A.C.	Changer, Tuning Ind.	(3) 6BA6, 6BE6, 6J6, 6AL5, 6AT6, 6V6, 6U5/6G5
BELMONT 11AF21	FM-AM	11	11/8	C C	None None	Ratio	1/4-wave Hank Loop	P-P	10" ED	5Y3	A.C.	Changer	(4) 6BA6, (2) 6C4, (2) 6K6, 6AT6, 6AL5
CROSLEY 38CR	FM-AM ⁴ 5	8	8/7	C C	None None	F-S	None Loop	S-E	PM or ED	5Y3	A.C.	Changer	(2) 6SG7, 6AC7, 7F8, 6H6, 6V6, 6SQ7
CROSLEY 148CP, 148CQ	FM-AM ⁶	14	13/9	C C	1 FM None	F-S	None Loop	P-P	12" PM	5U4	A.C.	Changer Tuning Ind., PB ⁷	(3) 6SG7, (2) 6SQ7, (2) 6V6, 6SA7, 6H6, 6AC7, 7F8, 6SH7, 6E5
ESPEY Chassis 7B	FM-AM	11	10/7	C C	1 FM None	Ratio	Fold. d'ple Loop	P-P	10" PM	5Y3	A.C.	None	6BA6, 7F8, 7AH7, 7SH7, 7A6, 6SG7, 7F7, 7Q7, (2) 7C5
FARNSWORTH GK-084 to -087	FM-AM	8	8/6	C C	1 FM 1 AM	Ratio	Fold. d'ple	S-E	PM	5Y3	A.C.	Changer	(3) 6SK7, 6SB7-Y, 6AG5, 6S8, 6V6
FREED-EISEMAN 30, 32	FM-AM ¹⁰	21	16/11	C C	1 FM 1 AM	F-S	Fold. d'ple Loop	P-P	12" woofer 3" tweeter	(2) 5U4	A.C.	Changer, Tuning Ind., FM Squelch	6H6, 6U5, (2) 6SA7, (2) 6SK7, 6SL7, (3) 6J5, (2) 6L6, (2) 5U4, (3) 6AG5, (2) 6SG7, (2) 6SH7
MOTOROLA 77XM21 to 77XM22B 77FM21 to 77FM23	FM ⁵ AM	6	6/5	Co-ax C	None None	F-S	Hank ⁸ Loop	S-E	5" PM	Selen.	AC/DC ⁹	Changer ¹⁰	(2) 12BA6, 50B5, 19T8, 12AT7, 12BE6
MOTOROLA 107F31	FM-AM ¹¹	10	8/7	Co-ax C	None 1 AM	Ratio	Loop Loop	P-P	12" ED	5Y3	A.C.	Changer PB Tuner ¹² (motor controlled)	(2) 6V6, 7W7, 6SQ7, 6SK7, 6AL5, 7Q7, 7F8, 6SG7
NATIONAL NC-108T, NC-108R	FM	11 ¹¹		C	1 FM	Ratio	None	S-E	5" PM	5Y3	A.C.	Tuning Ind.	(3) 6SG7, 6BA6, 6AG5, 6C4, 6H6, 6SJ7, 6V6, 6U5/6G5

(table continued on following page)

Manufacturer and Model No.	Tuning Range	No. of Tubes	Tubes in Use FM/AM	Tuning System FM/AM	R. F. Amplifier FM/AM	FM Discriminator	Built-in Ant. FM/AM	A. F. Amplifier	Loudspeaker	Rectifier	Line Operation	Accessories	Tube Complement
OLYMPIC 7-925, -934 -936	FM-AM	10	10/8	C	1 FM 1 AM	Ratio	Fold. d'ple Loop	P-P	12 ED	5Y3	A.C.	Changer	(3) 6BA6, 6AL5, (2) 6SQ7, 6BE6, (2) 6K6
PHILCO 48-472	FM-AM	7	7/6	C	1 FM None	Ratio	Hank ⁸ Loop	S-E	4 x 6 oval FM	117Z3	AC/DC		14F8, (2) 14H7, 12AW6, 14X7, 50A5
PHILCO 48-1290	FM-AM ¹⁴	13	11/9	C	1 FM None	L-I	Hank ⁸ Loop	P-P	ED 12-M	5U4	A.C.	Changer PB Tuner, Scratch Elimin.	(2) 6BA6, 6AU6, 7A7, 7F8, 7AF7, FM1000, 6SQ7, 7E7, 7F7, (2) 6V6
PHILCO 48-1274, 48-1276	FM-AM ¹⁴	16	13/12	C	1 FM 1 AM	L-I	Fold. d'ple Loop	P-P	14" woofer 5" tweeter	5U4-G	A.C.	Changer Auto. PB Tuning, Scratch Elimin.	6AU6, 7E5, 7B7, (2) 7H7, 7F8, FM1000, (3) 6J5, 7E6, 7F7, 7E7, (2) 6L6
RCA VICTOR 710V2	FM-AM	10	9/7	C	None None	Ratio	Fold. d'ple Loop	P-P	12" PM	5Y3	A.C.	Changer	(2) 6BE6, 6BA6, 6AU6, (2) 6SQ7, 6AL5, (2) 6K6
REL 646	FM	12	12	C	1 FM	F-S	None	P-P	None	5U4	A.C.	Field Strength and Tuning Ind.	(5) 7AG7, (2) 7C5, (2) 7F8, 7A6, 7F7
STEWART-WARNER A72T1 to A72T4	FM-AM	7	7/5	C	1 FM None	Ratio	Hank Loop	S-E	5" PM	Selen.	AC/DC		(3) 12BA6, 12H6, 6AQ6, 50B5, 12BE6
STEWART-WARNER A92CR3 A92CR6	FM-AM	9	9/7	P	1 FM 1 AM	Ratio	Fold. d'ple Loop	S-E	10" ED	5Y3	A.C.	Changer	(3) 6BA6, 6AL5, 6SB7-Y, 6SQ7, 6S17, 6V6
STROMBERG CARLSON 1210	FM ¹⁵ -AM	11	11/8	P	1 FM 1 AM	Ratio	None Loop	P-P	PM	5Y3	A.C.		(3) 6BA6, 6BE6, 6AU6, 6H6, 6AT6, 6SC7, (2) 6V6
WESTINGHOUSE H-161, H-168 (Ch. V-2118)	FM-AM	8	8/6	C	None None	Ratio	Fold. d'ple Loop	S-E	8" ED ¹⁶	5A24	A.C.	Changer	(2) 6BA6, 6J6, 7A6, 6L6, 6AT6, 6AU5
WESTINGHOUSE H-164, H-166, H-167	FM-AM	11 ¹⁸	10/8	C	1 FM None	Ratio	Fold. d'ple Loop	P-P	12" ED	5U4	A.C.	Changer	(2) 7F8, 6AU6, (2) 6BA6, (2) 6AT6, 6H6, (2) 6Y6, 6SC7 ¹⁵
ZENITH 7H820 (Ch. 7E01)	FM ¹⁵ -AM	7	7/6	P	1 FM 1 AM	F-S	Hank ⁸ Loop	S-E	PM	Selen.	AC/DC		(3) 12BA6, 12BE6, 12AU6, 19T8, 35E5

FM — 88 to 108 Mc
AM — 540 to 1600 kc (approx.)
C — Condenser tuning
P — Permeability tuning
F-S — Foster-Seeley discriminator
L-I — Locked-in oscillator
PM — Permanent magnetic dynamic
ED — Electro-dynamic
P-P — Push-pull
S-E — Single-ended

PB — Push-button
1 — First stage grounded-grid amplifier
2 — Conventional r.f. amplifier
3 — Plus the 9 to 15.5-mc short-wave band
4 — Plus the 9.4 to 11.9-mc short-wave band
5 — Double superheterodyne
6 — Plus 2.5 to 6.7 and 6.7 to 18.5-mc bands
7 — Push-buttons for tone control and BC tuning
8 — FM antenna in line-cord
9 — Series 77XM only, others straight a.c.
19 — Plus 6.2 to 9.9-mc and 12 to 17.5-mc bands

10 — On series 77 FM only
11 — Plus 5.6 to 12.2-mc band
12 — Any combination of 6 AM or FM stations
13 — 6U5/6G5 replaced by meter in NC-108R
14 — Plus 9.3 to 15.5-mc band
15 — Plus 44 to 50-mc FM band
16 — 10" speaker on Model H-168
17 — Changer on Model H-168 only
18 — A 6SC7 phono preamplifier is included on Models H-166 and H-167

"lock-in" with the i.f. signal and follow its variations. The current through the load resistor R1 is linear and inversely proportional to the frequency. Thus frequency variations are converted to linear a.f. voltage changes. The a.f. signal is taken from R1 and fed to the a.f. amplifier through a decoupling network.

Various tuning methods

The most noticeable difference in FM receivers is usually in the r.f. or front end. The methods of r.f. tuning include:

1. Varying a capacitor across a coil.
2. Varying the permeability of the coils by movement of an iron or brass slug through the cores.
3. Using special tuning elements like the Mallory-Ware Inductuner, the Guillotine or co-axial lines.

The circuit of the Philco Models 48-1274 and 48-1276 is one of the most interesting of those reviewed. The r.f. circuit, using a 6AU6 r.f. pentode, is standard. The 7F8 oscillator has some original features. It operates at half the frequency required to beat with the signal to produce the i.f. The other half is

a doubler supplying the heterodyning signal. This reduces oscillator drift.

The co-axial lines type of tuner is used in Motorola FM radios. The high Q of this type of tuning circuit makes it possible to dispense with r.f. stages to eliminate images. Indeed, so selective is the circuit that Motorola uses the low 4.3-mc i.f. which was standard in sets built for the old FM band, thus obtaining certain advantages in stability, gain, and ease of adjustment inherent in the lower intermediate frequency.

Some of the Motorola models are interesting also in that they use a Foster-Seeley discriminator without limiters. The manufacturers claim that with a signal tuned in exactly, noise impulses tend to balance themselves out across the two diodes of the discriminator.

The Inductuner, one of the simplest of all tuning circuits, is a set of inductors mounted on a rotatable form. Sliders make contact with each inductor, the amount of inductance varying as the form is turned. This type of tuning circuit has an enormous range, and is used with success to tune across both the FM

and both television bands (44 to 216 mc).

The General Electric Guillotuner is a modification of the "butterfly" tuning unit, and combines inductance and capacity in circuit unit. It, and the other tuning systems mentioned above, were

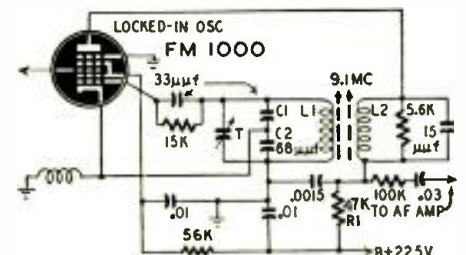
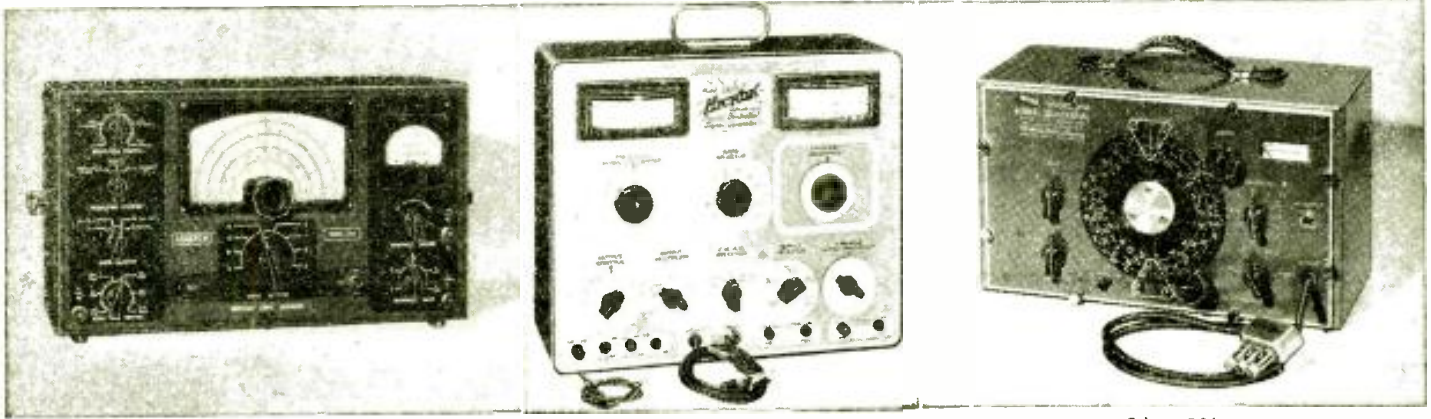

Fig. 1—Philco uses this locked-in oscillator.

described at some length in the December, 1947, issue of RADIO-CRAFT.

An electronic squelch circuit is a feature of the Freed-Eisemann Models 30 and 32. These sets use separate FM and AM tuner circuits. The FM tuner uses 10 tubes. The AM tuner uses a standard 4-stage plus tuning eye superheterodyne covering the standard broadcast band (Continued on page 52)



Jackson 641

Hickok 288X

Silver 906

FM SWEEP GENERATORS

By **BOB STANG**

CROSS INDEX OF POPULAR FM-AM SIGNAL GENERATORS

THE radio serviceman who is to continue to succeed must spend a portion of his time keeping up with technical developments in his field. With the advent of FM, television, automatic frequency control, noise silencers, and dynamic noise suppression, not to mention a number of developments at present in process, the serviceman is hard pressed to keep his technical knowledge at a level high enough to enable him to do a satisfactory job. This need is recognized by the number of new technical magazines which have sprung into being concurrent with these developments, as well as the increased circulation of the "old reliables," and the large number of pertinent books published. The enterprising technical man therefore has reams of material at his disposal.

While technical know-how depends partly upon how anxious each serviceman is to obtain it, the problem of selecting proper test equipment is another matter entirely. The only information on the subject generally available is from manufacturers' catalogs which, while very useful, are naturally biased in their own favor. More information for evaluating equipment features is needed so that the prospective buyer can weigh function against cost, and decide what is best for his individual needs.

FEATURES	JACKSON 641	HICKOK 288X	SILVER 906	G. E. YGS-3	TRIPLETT 3433	RCA WR-53A
Frequency range fundamentals	100 kc to 160 mc; 8 bands	100 kc to 160 mc; 7 bands	90 kc to 170 mc; 8 bands	100 kc to 150 mc; 7 bands	100 kc to 170 mc; 10 bands	85-110 mc; 8.3-10.7 mc
FM maximum deviation range	0 to ±400 kc	0 to ±450 kc	Not variable	0 to ±750 kc	25 kc steps to ±150 kc	±400 kc
FM sweep frequencies	Var. from 100 to 10,000 cycles	60 or 400 cycles	400 cycles or 400 kc	Var. from 100 to 12,000 cycles	60 or 400 cycles	60 cycles
Output calibration	Calibration meter; 5 ranges; 0 to 100kmv	None, db meter built in	Calibration meter; 5 ranges; 0 to 100kmv	Magic eye; no calibration	Meter, not Calibrated in mv	None
Amplitude modulation in cycles	60, var. 100 to 10 kc	60, 400 var. 0 to 15 kc	400	60, 400 var. 100 to 12 kc	60 400	—
Scope synchronization	Yes	Only 60 cycles	No	Yes	Yes	Yes
Phasing control	Yes	No	No	No	No	No
Variable amplitude modulation %	0 to 80%	No	0 to 50%	0 to 100%	No	—
Voltage regulation	Yes	No	Yes	No	Yes	No
Accuracy	1/2 of 1%; Fixed freq. standards—no beat adj. required	Set by beating against int. crystal	1%	Set by beating against int. crystal	1%	2%
Type of dial	Glass protected; Knife-edge pointer; Fixed dial	Glass protected; Fixed pointer; Rotating scale	Plastic protected; Rotating dial; Fixed pointer	Plastic protected; Rotating dial; Fixed pointer	Rotating wire pointer over etched panel	Glass protected; Fixed pointer; Rotating scale
Serviceman's price	\$159.50	\$159.06	\$116.50	\$195.00	\$157.50	\$162.50

Today's most useful piece of test equipment, with the possible exception of the oscilloscope, is the FM-AM signal gen-

erator. This instrument, if properly designed, can be used in conjunction with (Continued on page 60)



General Electric YGS-3

Triplett 3433

RCA WR-53A

ADVANTAGES OF FM

The listener to frequency-modulated programs hears more stations and better music undamaged by interference, natural or man-made.

By LEIGH L. KIMBALL*

THE frequencies from 88 to 108 megacycles today embrace the finest system of aural broadcasting which has been available to the public since the beginning of radio history. Yet not so long ago it was believed that any frequency above 30 megacycles was limited strictly to service as far as the horizon and that the generation of large amounts of power at these shorter wave lengths was an impossibility. It took World War II to inspire the miracles of engineering which have made it possible to develop kilowatts of power in the vicinity of 100 megacycles.

The miracles were not confined solely to transmitting developments. Receiving-tube design also advanced, keeping step with transmitter research. A tremendous amount of research was also undertaken on high-frequency antennas and v.h.f. propagation. The accumulated experience led the Federal Communications Commission to assign FM broadcasting to the 88 to 108-megacycle band which only a few years before had been considered an absurd assignment for broadcast service.

How greatly FM has progressed since its original assignment to this frequency band is illustrated by the fact that there are now a number of FM broadcast stations operating with effective power in excess of 200 kilowatts. It is estimated that there are over 1,620,000 FM home

receivers in use today. They are common pieces of living room furniture, whereas ten years ago a superheterodyne receiver operating at 100 megacycles would have been even a laboratory curiosity.

Now comes the question—of what use and what advantage is this new system of broadcasting to the average person? The first advantage is the well-known one of high audio fidelity. The chart in Fig. 1 shows the extended audio range possible with FM. Full frequency response to the limits of human hearing is possible because the 20-megacycle width of the FM broadcast band accommodates wide-band stations with ease, whereas the approximately 1-megacycle wide AM broadcast band poses a problem of frequency conservation. In addition wide-band FM is inherently free from noise.

The FCC has set up frequency-response standards and requires compliance with these standards within + or - 1 db from 50 to 15,000 cycles. Distortion requirements are as follows:

Modulating Frequency (Cycles)	Maximum Permissible Distortion (%)
50 to 100	3.5
100 to 7500	2.5
7500 to 15000	3

Before a license is issued, the larger FM Stations are required to submit actual measurements from microphone terminals to antenna showing that the

over-all system has the required frequency response and meets distortion specifications.

The advantages of FM are not limited to high-quality program transmission only. FM offers real benefits to broadcast listeners who live beyond the normal nighttime service ranges of AM transmitters.

The degree to which AM broadcasting deteriorates at night is amazing. Millions of listeners in this country who live in rural and semirural areas nightly experience a tremendous reduction in available AM program service. The number of stations in the country has more than doubled since the end of the war. Right now, there are more than 1,970 AM stations on the air or under construction. As a result, most of them are operating under increased interference conditions at night when sky waves

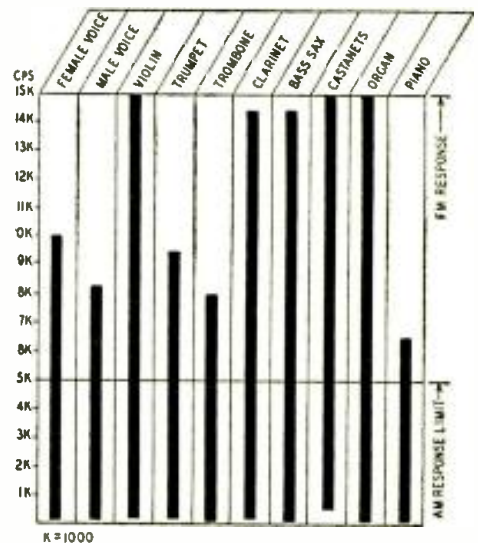
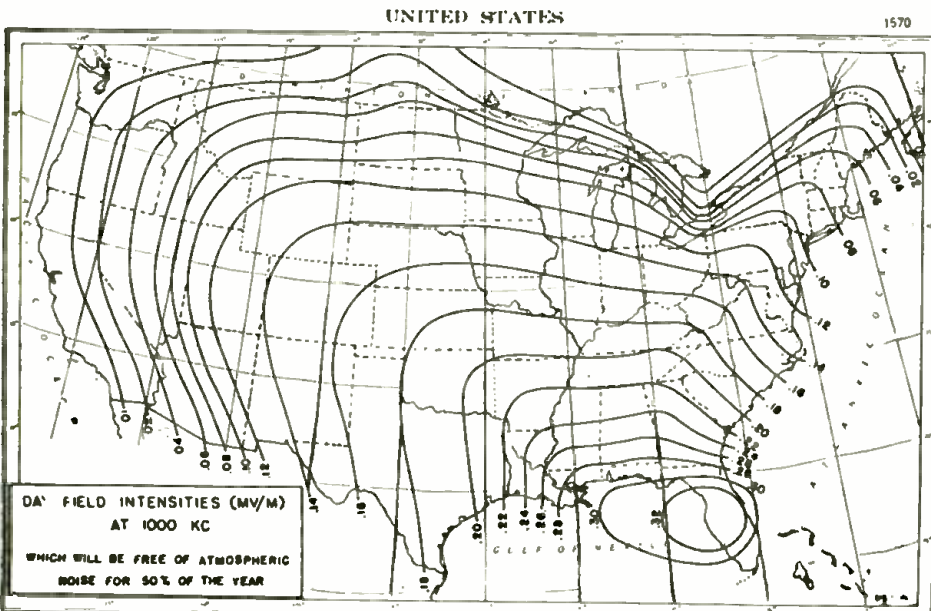

Fig. 1—FM reproduces the full audio range.

cover tremendous distances compared to ground-wave coverage in the daytime. After sundown, these sky waves may travel halfway or further across the country, to interfere with any or all other stations on the same channel. In the early days of broadcasting, when there were fewer stations, sky-wave transmission was a boon—people developed their first keen interest in radio by sitting up into the wee small hours to listen to distant stations. But today, sky-wave propagation in the form of interference from other stations on his channel has become a plague to the broadcaster.

Of the AM stations now licensed, 851 (more than half) are class IV locals, all

RADIO-CRAFT for



The map above shows how serious are the effects of static on ordinary AM transmissions. Many southern areas can have satisfactory radio program service only with static-free FM.

of which are crammed into six of the 101 channels available for AM broadcasting—an average of about 142 stations per channel. These stations range from 100 to 250 watts and serve a radius of anywhere from 20 to 50 miles in the daytime, depending upon frequency and soil conductivity in the area. At night, the interference-free coverage of a local station in most areas is reduced to something less than a 5-mile radius, due to interference from all the other stations on the same channel.

FM coverage area is practically constant. The distance signals can cover at this high frequency is roughly the same during day or night. Interference from other FM stations is much less than with AM because the desired FM signal need be only twice as strong as the interfering signal on an adjacent channel to blanket it completely. A desired AM signal must be 100 times stronger than an interfering AM signal.

Because of these factors, a greater number of FM stations can be assigned in a given area, and can give more complete coverage than a smaller number of AM stations. This is a much more effective system for all concerned—the broadcaster, the time-buying advertiser, and the vast majority of listeners. Because of the stability of FM coverage, it was possible for the FCC to set up a tentative allocation plan to serve as an allocation guide for FM broadcasting throughout the country. The plan provides for two types of FM broadcast stations. The first is the class A station, designed to serve small communities and towns other than the main city of an area and its surrounding rural area. These stations are limited to an effective radiated power (effective radiated power = transmitter output power × antenna power gain × transmission line efficiency between transmitter and antenna) of 1 kilowatt and an antenna height of 250 feet above the average terrain. Twenty FM channels have been set aside for use by class A stations.

The second type is the class B station, designed to render service primarily to a metropolitan district or principal city and its surrounding rural area.

The allocation plan also divides the United States into two areas to tailor the class B stations to the different needs of the country. Area I includes southeastern New Hampshire; all of Massachusetts, Rhode Island, and Connecticut; southeastern New York as far north as Albany-Troy-Schenectady; all of New Jersey, Delaware, and the District of Columbia; Maryland as far west as Hagerstown; and eastern Pennsylvania as far west as Harrisburg. These are generally the more densely populated areas which can better support a larger number of FM stations, but other sections may be added as required. The rest of the country is in Area II.

Class B stations in Area I are licensed to operate with not less than 10-kw effective radiated power with an antenna height of 300 feet and a maximum of 20-kw effective radiated power with an

antenna height of 500 feet. If the antenna height is greater than 500 feet, the radiated power must be scaled proportionately but in no case may the radiated power exceed 20 kilowatts. As an example, the radiated power must be reduced to 3 kilowatts for an antenna height of 1,000 feet. Incidentally, this illustrates graphically the relatively tremendous effect upon coverage of height as compared to the effect of power.

The minimum power in Area II is 2 kw and the minimum antenna height is 350 feet. No limit is placed upon the power and antenna height of class B stations in Area II, provided that the new station does not interfere with existing stations. Consequently, stations in this area are able to serve the sprawling rural area. A considerable number of construction permits have been issued for 450-kilowatt stations.

As an example of the way the tentative allocation plan works, 20 class B channels have been assigned to serve the entire metropolitan area of New York City on a constant day-and-night basis. In addition to these 20 channels, there are 13 class A channels available to serve local interests, making available a total of 33 FM stations in the New York area.

The pattern is the same throughout the country. In general and wherever practical, cities have been assigned

channels on a population basis. Smaller cities capable of supporting relatively few stations have been assigned relatively few channels, and the larger cities have been assigned correspondingly

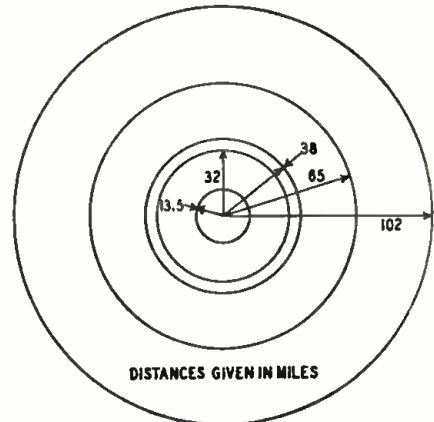

Fig. 3—Approximate ranges of FM stations.

larger numbers of channels. Because of methodical planning by the FCC, the most efficient channel usage for FM broadcasting facilities has been assured.

The map in Fig. 2 illustrates what coverage may be obtained by FM stations according to the coverage prediction system set up by the FCC. It compares the predicted coverage area of one FM station with the coverage ac-

(Continued on page 60)

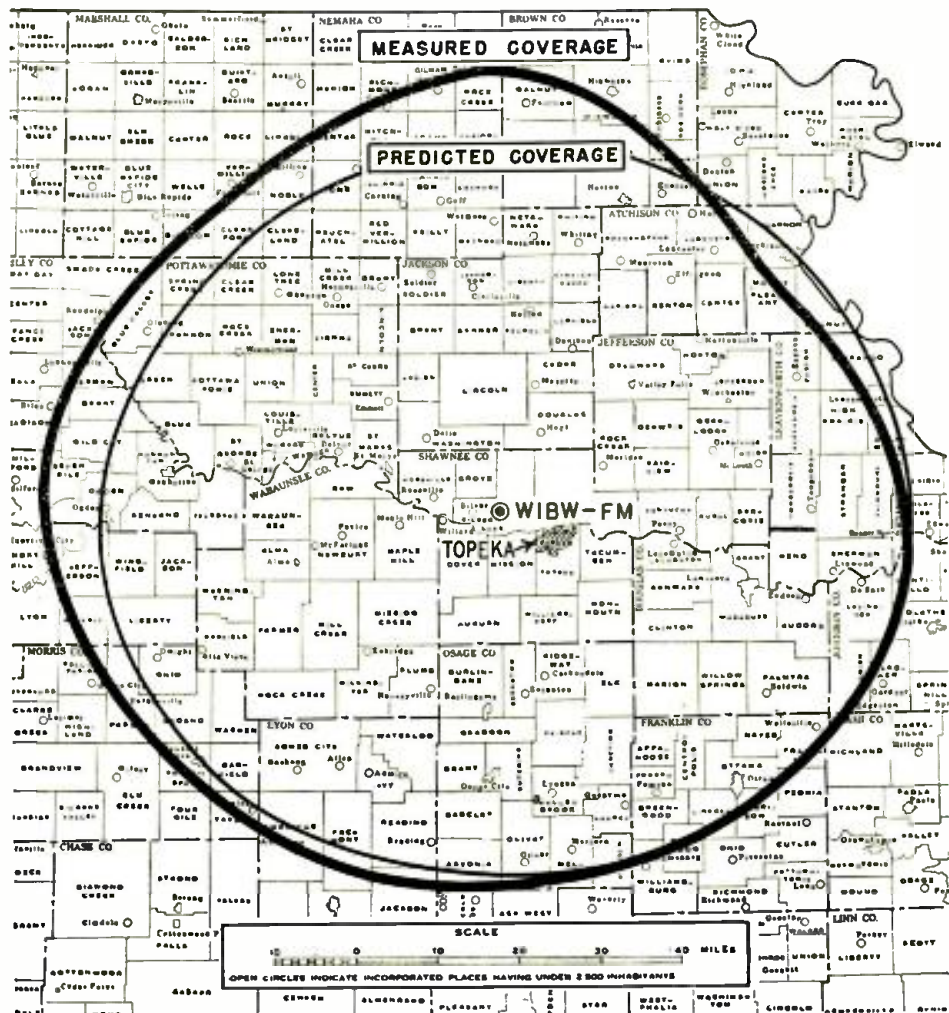
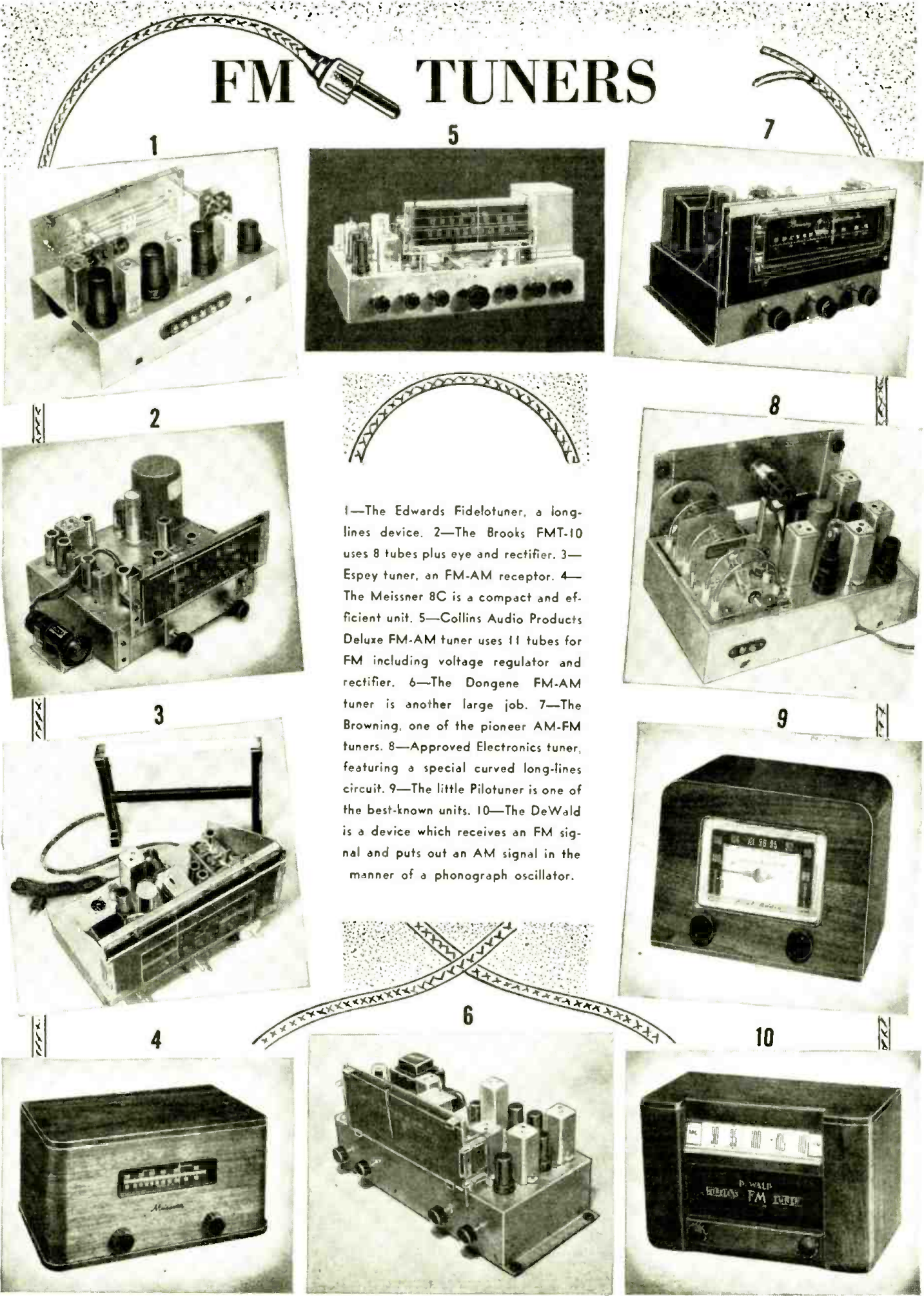

Fig. 2—Correlation between predicted and actual coverage of typical FM broadcast station.

FM TUNERS



1—The Edwards Fidelotuner, a long-lines device. 2—The Brooks FMT-10 uses 8 tubes plus eye and rectifier. 3—Espy tuner, an FM-AM receptor. 4—The Meissner 8C is a compact and efficient unit. 5—Collins Audio Products Deluxe FM-AM tuner uses 11 tubes for FM including voltage regulator and rectifier. 6—The Dongene FM-AM tuner is another large job. 7—The Browning, one of the pioneer AM-FM tuners. 8—Approved Electronics tuner, featuring a special curved long-lines circuit. 9—The little Pilotuner is one of the best-known units. 10—The DeWald is a device which receives an FM signal and puts out an AM signal in the manner of a phonograph oscillator.

FM tuners may be almost as satisfactory as complete receivers to listeners with good AM receivers

FM is no longer the coming form of radio broadcasting. It has arrived! There are now more than 500 FM stations actually on the air, and 1,000 are expected before the end of the year. Yet many listeners are still without FM receivers. There are two main reasons for this lack. Supply of FM receivers has not been equal to the demand (at least until very recently) and many owners of good AM receivers have hesitated to buy a new set just to get the extra FM band.

FM receivers to suit all tastes and purses are daily becoming more available, so the problems of the first group are rapidly reaching the vanishing point. For the second group—those with the fine AM receivers—an FM tuner may well be the answer. They are readily available, their cost is lower than that of a complete receiver (varying from about \$30 to \$130 for straight FM tuners), and they can be attached immediately to any radio which has a phonograph input. If the radio is not so equipped, the local serviceman can install one easily.

For worth-while FM reception, the original receiver must have an excellent audio end. If not, quality will be little better on FM than on AM. Where natural static or electrical interference ruins AM reception, the listener may find it desirable to get interference-free reception with an FM tuner, even though his AM receiver is not a high-

fidelity type as required for best results.

The would-be FM listener has as wide a choice among FM tuners as among receivers. They vary as widely in characteristics as in price. Small 5-tube jobs are available for the person who wants a simple, low-cost tuner. The listener who lives far from FM stations will prefer to use a bigger one, with (at least) two i.f. stages and possibly also an r.f. stage. The listener in a big city, with many powerful FM broadcasters, will be more interested in the r.f. stage as an interference eliminator. For the same reason, he will be attracted by the double-conversion feature of some of the circuits. Other units are equipped with AM tuners as well, and need only an excellent amplifier and speaker to be a high-fidelity receiving system.

Among the most interesting technical variations are those in the tuning circuits. Two—the Edwards Fidelotuner and the Approved—use modified long-lines circuits. In the Edwards tuner, these lines are straight, approximately 5½ inches long, and ½ inch apart. One set tunes the r.f. and the other the oscillator section of the 6J6 converter tube. The two sets of lines are mounted below each other in polystyrene end blocks and are tuned by a pair of shorting strips, mounted in a polystyrene block and moved along the lines by the dial cord. Both sets are loaded with small coils and are tracked with trimmer condensers.

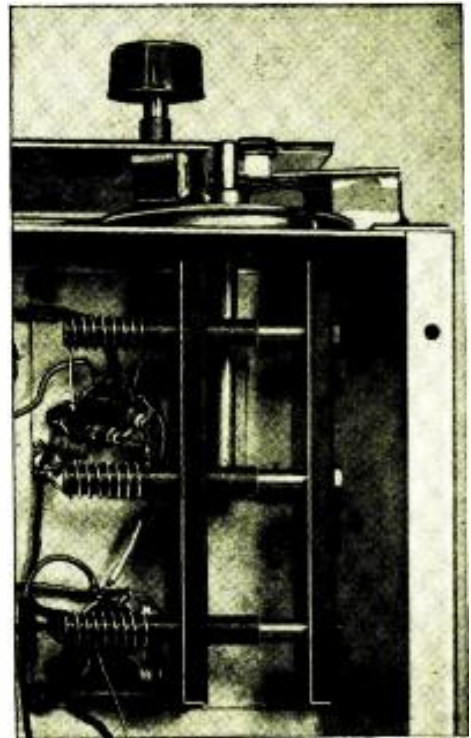

Permeability-tuned coils of the Brooks tuner.

Circular long lines

In the Approved Electronic Instrument set, the long lines are ingeniously bent into a semicircle. The shorting blocks thus have a rotary motion and are attached directly to the tuning shaft. The lines also have end coils and trimmer condensers, though tracking adjustments may be made by moving the shorting blocks slightly on the shafts, to which they are attached with setscrews.

Effect on performance does not appear. (Continued on page 52)

CHARACTERISTICS OF THE MORE POPULAR FM TUNERS

TUNER AND MODEL	LINE OPERATION	NO. TUBES	R.F.	MIXER	I.F.	LIMITER	DISCRIMINATOR	OTHER FEATURES
Approved Electronic Inst.	a.c. 7Y4	6	6AG5	6J6	2-6SH7	6SH7	6AL5 F-S	
Brooks	a.c. 6X4	8	6AK5	6BE6	3-6AK5	2-9001	6AL5 F-S	6U5 tuning indicator
Browning RJ-12	external pack	8	6BA6	6BE6 6C4	2-7AG7	2-6SJ7	6H6 F-S	separate AM channel
Browning RV-10	a.c. 80	7	6AU6	7F8	2-6AU6	2-6SJ7	6H6 F-S	6U5 tuning indicator
Collins Audio Products	a.c. 6X4	9	6J6	6AK5 6C4	3-6AG5	2-9001	6AL5	6AL7 indicator
Collins Audio Products FM-AM Tuner	a.c. 5Y3/GT	9	6J6	6AG5 6C4	1-6AK5 2-6AG5	2-9001	6AL5	V-R tube, audio channel 6AL7 indicator
De Wald	a.c.-d.c. 35W4	5	none	12AT7	2-12BA6	none	12AL5 F-S	12SA7 oscillator
Dongene	a.c. 5Y3	8	6BA6	6BE6 6C4	2-6SG7	2-6SJ7	6H6 F-S	separate AM channel
Edwards Fidelotuner	a.c.-d.c. selen.	5	none	6J6	2-6SH7	6SH7	6H6 F-S	long-lines tuner ckt.
Espey 512	a.c. 5Y3-GT	6	6BA6	6BE6 6C4	2-6SG7	none	6AL5 ratio	also AM tuner 6U5 indicator
Meissner 8C	a.c. 6X5-GT	7	none	2-6AG5 6C4	2-6BA6	none	6AL5 ratio	
Meissner 9-1093	external pack	9	none	2-6AG5 6C4	3-6AG5	2-9001	6AL5 F-S	AM channel, 6U5 indicator separate
Pilotuner	a.c. selen.	5	6BA6	6BE6	2-6BA6	none	6AL5 ratio	

FM Receiver Servicing Technique

By MILTON S. KIVER

The author discusses and solves many problems met in FM receivers. He emphasizes visual alignment methods.

WHEN an FM receiver is brought in for repair, several preliminary tests can be applied to localize the trouble quickly. In many cases these tests save the serviceman considerable time.

Many present FM receivers combine AM and FM in one unit. If the set is normal on the AM bands, but completely inoperative when turned to FM, then the trouble must be in some portion of the receiver which deals exclusively with the FM signal. The audio amplifier and the power supply can be eliminated immediately. Separate i.f. coils are used for each signal, and an open or short may exist in the FM coils. Open leads can be discounted because, in practically all combination circuits, the i.f. coils are connected in series. An FM coil may have shorted out, but this is not a common occurrence and may be discounted at first.

Phonograph attachments can reveal whether or not the power supply and

audio system are functioning, when neither AM nor FM signals are reaching the loudspeaker.

AM and FM receiver differences

Standard broadcast AM and FM receivers differ basically in two respects: frequency of operation and type of detector.

The FM band is from 88-108 mc. At these frequencies, the usual variable condenser and coil arrangement is not too satisfactory. Such tuners are still found in some receivers, but most receivers are tuned by keeping the capacitance fixed and varying the inductance. Thus, Zenith employs permeability tuning, G-E uses guillotines, and Motorola resorts to tuned lines.* Replacements in the r.f. section must be exact duplicates of defective parts. Connecting leads should be kept short, and special care

must be taken not to disturb the placement of other parts.

The FM detector, in 98 out of every

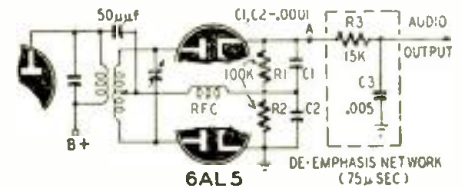

Fig. 1—The well-known Foster-Seeley circuit.

100 receivers, is usually either one of two types:

1. The Foster-Seeley discriminator.
2. The ratio detector.

In the Foster-Seeley circuit (Fig. 1) the audio output voltage is developed across the resistors R1 and R2. This voltage is passed through a de-emphasis network to the audio amplifier. The network reduces the amplitude of the higher-frequency components of the audio signal. This is necessary because the transmitter boosts the amplitude of these frequencies to reduce noise which accompanies the signal.

The frequency characteristic of this detector is the S-shaped curve in Fig. 2. Its linear portion is the useful section of the curve. A certain amplitude of output voltage is derived for every frequency variation. If the curve is off-center (Fig. 3-a) or the center section is not linear (Fig. 3-b), distortion results.

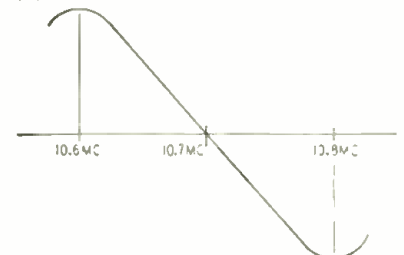
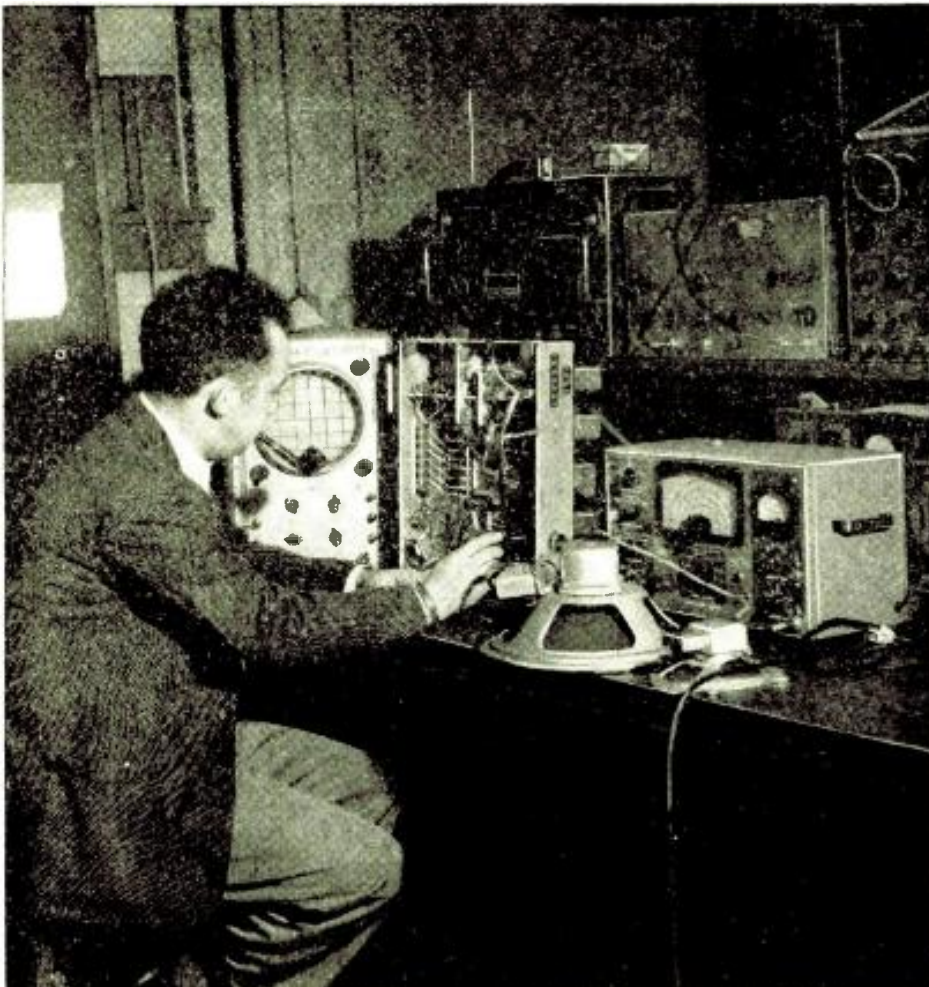

Fig. 2—A good discriminator curve is linear.

The Foster-Seeley discriminator is almost always preceded by a limiter stage whose function is to remove all amplitude variations from the incoming signal. If the frequency variations are accompanied by amplitude variations, these will be detected by the diode rectifier tubes and appear as distortion in the reproduced audio signal.

The limiter is generally a sharp cut-off tube operating at low plate and screen voltages, and with grid-leak bias (Fig. 4). The bias across Rg varies with the amplitude of the signal, and tends to level off all amplitude variations. The low plate and screen voltages permit the tube to saturate easily. As long as the signal is sufficiently powerful to drive



Service engineer at Howard W. Sams checks an FM receiver, using visual alignment method.

the limiter to saturation, reception is noise-free. The hiss heard between stations illustrates what happens when the limiter is not saturated.

Since the voltage across Rg varies with signal amplitude, a vacuum-tube voltmeter or oscilloscope at this point indicates how well the r.f. and i.f. amplifiers have been aligned.

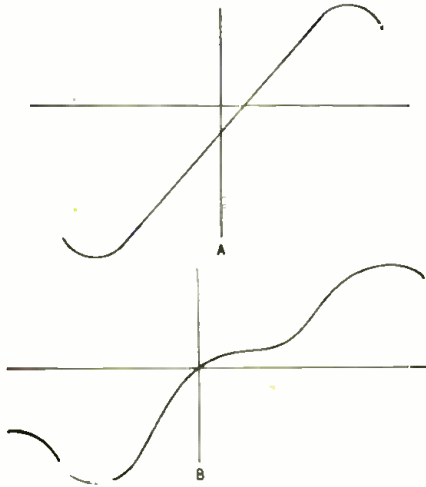

Fig. 3-a, top and 3-b, bottom—Curves like these will produce a distorted a.f. signal.

Some receivers have two limiters in series. In this case, the test point is shifted from the grid circuit of the first limiter to a similar position in the second limiter. The lowest readable signal voltage should be used, when testing, in order not to saturate the first limiter stage. If saturation occurs, the meter will not indicate each change in signal amplitude.

The ratio detector is shown in Fig. 5. Changing voltages across C1 and C2 produce an audio voltage across R3 which passes through a de-emphasis network to the audio amplifier.

Points for the repairman

The voltage between point A and ground depends upon the strength of the incoming carrier. If the incoming broadcast signal is replaced by voltage from a signal generator, then the voltage at A will be maximum when the i.f. transformers are aligned.

Since the audio output voltage is developed across R3, point B is a good spot to place the oscilloscope when the ratio detector is being adjusted. When the primary and secondary of T1 are properly aligned, the audio output is zero when the incoming signal is precisely at the i.f. center frequency. Signals with frequencies above and below this point will produce negative and positive voltages at R3. Thus, the S-curve of Fig. 2 represents the characteristics of a ratio detector, as well as the Foster-Seeley detector. Since the ratio detector does not respond to amplitude variations, it does not require a limiter.

A variation of the ratio detector is shown in Fig. 6. Comparison reveals that point B in each diagram is actually at the same point in the circuit. In place of the r.f.c. of Fig. 5, we now have L3, which is inductively coupled to L1 and receives its reference voltage from

it. The r.f. choke (Fig. 5) obtains its voltage from L1 through C5.

The change from the balanced to the unbalanced circuit will affect the method of aligning the detector. To align the unbalanced detector, first connect two 68,000-ohm resistors in series across R1. Connect a vacuum-tube voltmeter between points B and C. Adjust the trimmers for zero reading on the meter, with a signal at the intermediate frequency. For frequencies above and below this point, the voltage will be either positive or negative, to produce the characteristic S-curve.

In summary, then, FM receivers have several test points which help the serviceman to localize defects in the circuit. For receivers employing the Foster-Seeley type of discriminator, a test point exists in the grid circuit of the preceding limiter or at the output of the discriminator. In the ratio detector an indication can be obtained at point A or across the audio output.

The necessary instruments

1. A sweep signal generator, with frequency ranges from 5-15 mc and 80-110 mc, a maximum frequency sweep of 750 kc being desirable on both ranges;
2. A vacuum-tube voltmeter;
3. An AM signal generator with a frequency range from 5-125 mc;
4. An oscilloscope.

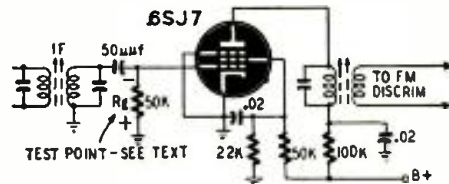

Fig. 4—A limiter precedes the discriminator.

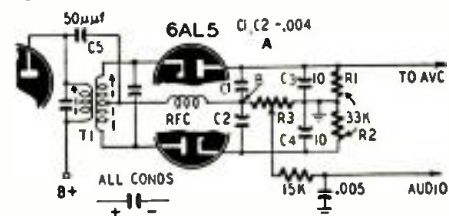

Fig. 5—The original ratio detector circuit.

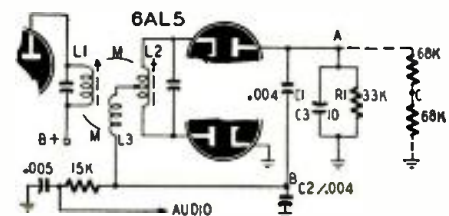

Fig. 6—A variation of the ratio detector.

FM receivers can be repaired with only a vacuum-tube voltmeter and an AM signal generator. But time is money to the serviceman, and all four items are required if repairs are to be made in the shortest possible time. A sweep signal generator produces the full circuit response in one pattern; an AM signal generator can provide information concerning only one point at a time.

The general procedure for trouble shooting an FM receiver by signal tracing is the same as for AM sets. The

audio amplifier is tested by applying an a.f. signal to the grids of the audio amplifier tubes.

The FM detector is next. Connect the sweep signal generator to the grid of the tube preceding the FM detector. Set it to sweep 300 kc above and below the i.f. center frequency. Connect an oscilloscope across the output terminals of the detector.

The shape of the S-curve on the oscilloscope screen tells the complete story about the operating condition of the detector. If the coupling network connecting the FM detector to the previous stage is not properly tuned or centered; the S-curve appears as shown in either Fig. 3-a or 3-b. In either case, the sound output is badly distorted. Adjust the trimmer condensers (or iron cores) in the discriminator primary and secondary windings to correct this condition. The primary controls the linearity of the center portion of the S-curve, while the secondary adjustment affects the centering of the S-curve.

Fig. 7 shows the S-curve when the band width of the tuning circuits is too narrow. The output is distorted when the incoming signal is fully modulated, and the voices appear "hissy" and "raspy." The solution is to realign the circuits.

To obtain marker points on the discriminator curve, connect the AM signal generator in parallel with the leads of the sweep generator and tune it to the frequency to be checked. If the frequency is 10.7 mc, a wiggle (Fig. 8) will be visible at the 10.7-mc point on the S-curve on the oscilloscope screen. Check the extent of the linear portion of the S-curve by shifting the frequency of the AM generator.

When the test must be made with an AM generator, the process is lengthened considerably because only one point can be tested at a time. Here is how to proceed in such a case.

For the Foster-Seeley discriminator (Fig. 1), connect the generator to the grid of the preceding tube. Next, connect a vacuum-tube voltmeter between point A and ground (Fig. 1). Set the signal generator to frequencies 25, 50, 75, and 100 kc above and below the intermediate frequency. Voltage readings should be the same for frequencies equally above and below the center frequency. Equal values indicate a linear discriminator characteristic. If the response is not linear, then the primary and secondary discriminator windings

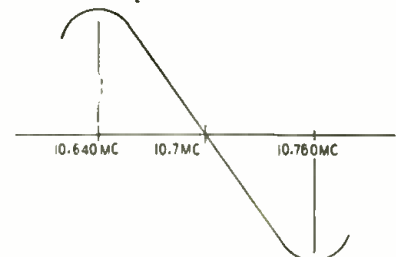
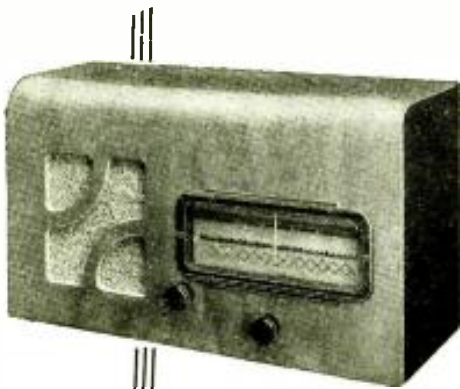

Fig. 7—A curve with too narrow band-pass. must be readjusted.

The method of testing the ratio detector depends upon its form. If it is

(Continued on page 58)



Simplified FM Receiver Uses Crystal Detector

By ROBERT E. ALTOMARE

AS the result of many previous experiments, I decided to design an FM tuner that anyone but the greenest beginner could easily construct. Simplification was the chief objective. The tendency toward instability is minimized by reduced stage gains and correct physical circuit layout. Circuit values are kept well below the critical point, allowing possible wide variations.

The tuner has four tubes: 6AG5—r.f. amplifier; 7F8—mixer-oscillator; 6BA6—first i.f. amplifier; and 6AG5—second i.f. amplifier. A 1N35 dual germanium crystal unit is the detector, although a 6AL5 dual-diode can be substituted with equal results. A 5Y3-GT rectifier is employed.

The frequency range of the receiver was extended to 86.3—109.3 mc because some constructors, however careful, might end up with too much capacitance across the tuned circuits and a reduced tuning range. It is better to recognize this possibility in advance and avoid the disappointment of a limited tuning range.

The tuning section

The complete circuit is shown in Fig. 1. The r.f. section is tuned by a three-gang variable capacitor. Each section has its individual trimmer. These are set initially at one turn from maximum-capacitance positions.

The r.f. amplifier is conventional, but it is especially useful if the tuner is

located at considerable distance from broadcast stations. In addition, it prevents loading of the mixer tank by the antenna and minimizes oscillator radiation. Cathode bias is supplied by the 220-ohm resistor connected between cathode terminal No. 2 and ground. Terminal No. 7 is the return point for the screen and plate bypass capacitors. The plate load inductor L1 has an inductance of 4.25 μ h. It is available commercially (Electrical Reactance type 165), but a substitute can be wound with 50 turns of No. 30 enameled wire on a 100,000-ohm, 5/32-inch diameter insulated, carbon resistor. The effective Q will be about 65.

A 15,000-ohm resistor reduces the plate voltage to approximately 145, and also acts as a decoupling resistor. The screen voltage is 150. The resistor in the control grid circuit reduces any tendency to oscillate. If the circuit does not oscillate, omit the resistor.

The r.f. tuning coil is self-supporting. It is made of 2½ turns of No. 14 tinned wire, ⅜-inch inside diameter. Solder it between the stator terminal of the tuning condenser and to the same ground as R1. One and one-half turns of hook-up wire interwound with the r.f. coil is suitable for a 300-ohm folded dipole. A 72-ohm antenna will require only a single loop of wire for coupling.

Mixer and oscillator

The mixer tuning inductor is similar to the r.f. coil. The coupling condenser is

tapped at ½ turn from the hot end. The mixer plate circuit is made inductive by L2. This coil consists of 15 turns of No. 22 enameled wire wound around a 3/16-inch diameter, 1,500-ohm resistor. Return all ground connections in this circuit to the same point on the chassis, preferably to the frame of the tuning capacitor.

The oscillator is a Hartley type and tunes 10.7 mc higher than the incoming signal frequency. Make the oscillator coil of 1¼ turns of No. 14 bare tinned wire wound on a ⅜-inch form. The oscillator tap connection is not critical. Attach it to a point about ½-turn from the plate end.

Fig. 2 is a suggested circuit layout for the oscillator. Wiring is simplified, and the leads are short.

The oscillator is coupled to the mixer through a small capacitor, C1, made by twisting two 1-inch lengths of No. 18 insulated wire together. Solder one wire to terminal No. 1 and the other to terminal No. 8 of the 7F8 socket. Capacitance can be reduced by untwisting the wires. The two r.f. chokes in the 7F8 and r.f. 6AG5 filament leads consist of 25 turns of No. 26 enameled wire, wound on 68,000-ohm, ½-watt insulated resistors (L4, circled 7 and 8).

The i.f. amplifier section

The tuner has two i.f. amplifier stages.

The 1st i.f. amplifier tube is a type 6BA6; the second, a type 6AG5. Differ-

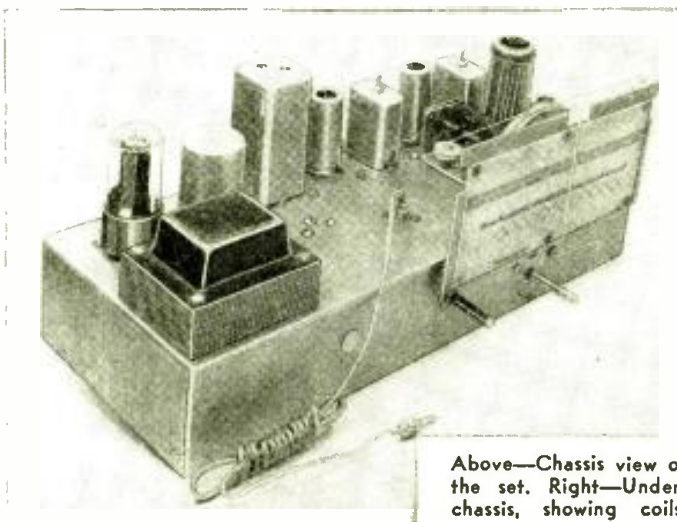

Above—Chassis view of the set. Right—Under-chassis, showing coils.

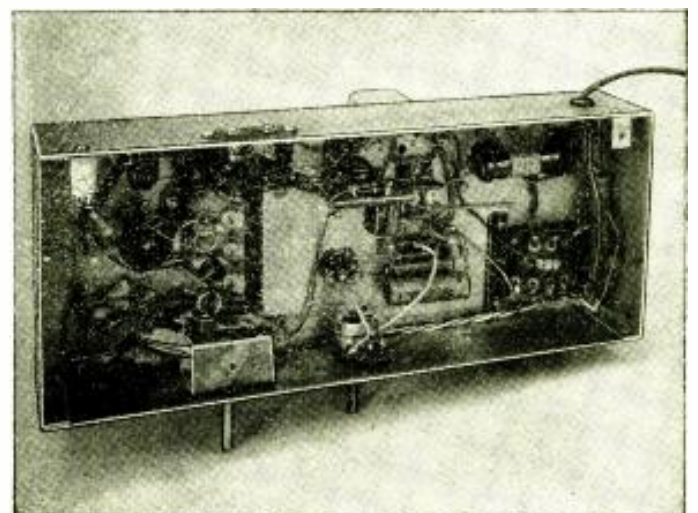

RADIO-CRAFT for

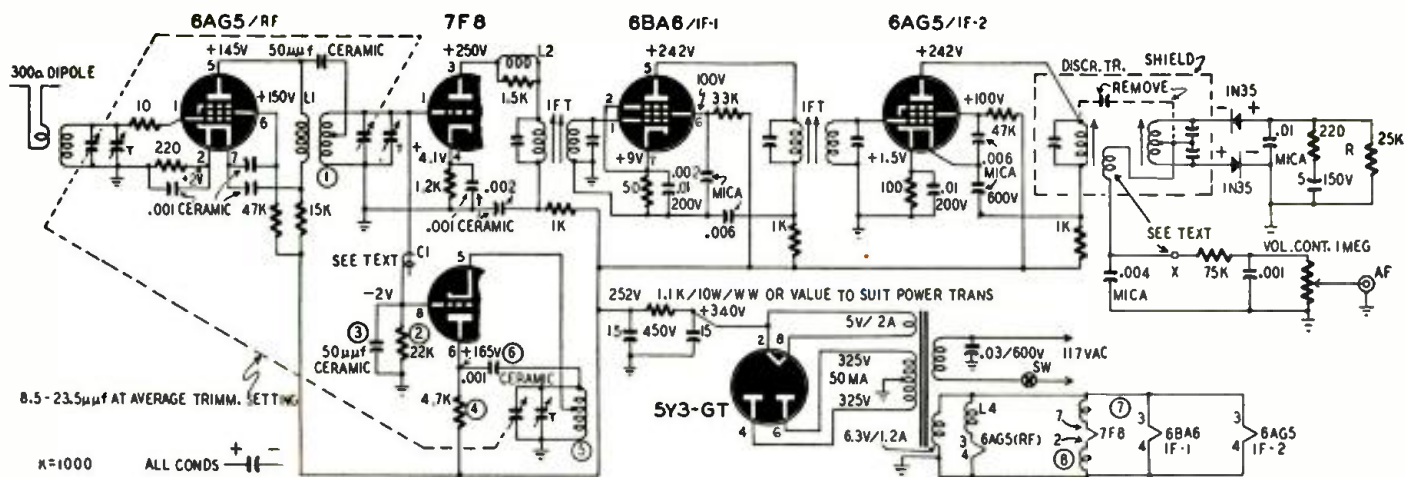

Fig. 1—The schematic. The IN35 crystal is actually two IN34's, carefully matched for equal output. Circled numbers refer to Fig. 2.

ent tubes were used only to emphasize that different types are usable.

The i.f. transformers are slug-tuned to 10.7 mc. Any make can be used.

Orient the 6BA6 and 6AG5 sockets and the transformers to keep the grid and plate leads comparatively short.

Assemble the components of the second i.f. amplifier stage on a terminal board in their entirety.

The final stage is a modified ratio detector. Audio output is taken from a tertiary winding on a standard discriminator transformer. Make this winding of 5 turns of No. 26 sec wire, wound over the cold end of the primary, and in the same direction (Fig. 3). Connect the hot end of this winding to the center tap of the secondary coil. The other end supplies audio output. This lead also connects to ground through a .004- μ f mica capacitor. It will be necessary to remove the coupling capacitor normally connected between the plate lead and the center tap of the secondary winding.

The 75,000-ohm resistor and .001- μ f condenser form a 75-microsecond deemphasis network to neutralize the pre-emphasis inserted at the transmitter to reduce noise. A 1-meg volume control allows control of the output.

Note that the output of a ratio discriminator is half that of a conventional discriminator for a given signal input.

Automatic volume control can be added easily to this FM tuner. It is preferable to control only the last i.f. stage, although sometimes it is also desirable to control the r.f. stage. Fig. 4 shows the circuit for applying a.v.c. to both.

Physical layout

Take care to align the tuning capacitor with the dial. Place the r.f. tube close to the r.f. of the tuning capacitor; the 7F8 should side-straddle the mixer and oscillator sections. See Fig. 2.

Mount all the main components first, and then wire the power supply and filament circuits. Keep the r.f. stage filament choke at least 2 inches away from the r.f. coil. Next wire the discriminator and the i.f. circuit. Test and align the i.f. stages with a signal generator at this point. Hook up the oscillator, mixer, and r.f. stages, following Fig. 2 closely.

Before trying to "get music" from the tuner, check all the circuits. The

d.c. voltages should agree with those indicated in Fig. 1. Measure the oscillator grid voltage with a vacuum-tube voltmeter. Lack of oscillator grid voltage means an inoperative oscillator. This might be due to a bad tube, parts or wiring.

If all voltages are approximately correct, align and track the tuner. A signal generator is practically a necessity. Connect it between the mixer grid and ground and adjust the i.f. transformers and the primary of the discriminator transformer for maximum d.c. voltage across resistor R.

To align the r.f. section, apply the signal generator to the dipole input terminals through two 300-ohm carbon resistors (70-ohm resistors for a 72-ohm dipole). Set the signal generator to 109.3 mc and completely unmesh the tuning capacitor. Now adjust the oscillator trimmer for maximum voltage output across R. There will be two voltage peaks as the trimmer is opened. The second is the correct one.

Now decrease the frequency of the signal generator and at the same time increase the capacitance of the tuning capacitors, continually following the signal at the same time, until the tuning capacitor is entirely meshed. If the signal generator reads about 86.3 mc, the oscillator is correctly adjusted.

If the generator frequency is considerably different from 86.3 mc when the oscillator capacitor plates are "all in," the oscillator inductance is incorrect. For a lower frequency than 86.3 mc, decrease the oscillator inductance by spreading the turns and repeat the whole procedure. If the frequency is greater than 86.3 mc, increase the oscillator inductance by squeezing the coil. If necessary, wind another coil with an additional quarter-turn.

To align the r.f. and mixer sections, set the signal generator to 109.3 mc and again set the capacitor to minimum, tuning in the signal. Adjust the r.f. and mixer trimmers for maximum output. Now retune both the signal generator and tuner to 86.3 mc and check the r.f. and mixer trimmers. If either of these must be tightened the corresponding inductance is too low and should be increased by squeezing. But if either must

be loosened for maximum output, reduce inductance by spreading turns.

Now align the discriminator transformer. Connect two closely matched 75,000- to 100,000-ohm resistors across

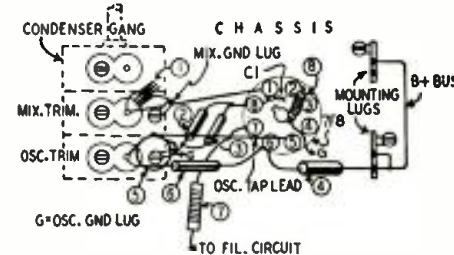

Fig. 2—Detail of part of r.f. section. Numerals on socket indicate pin numbers. Circled ones refer to points on schematic. C1 is a single twist of wire between pins 1 and 8 (gimmick).

R. Place the common lead of a d.c. v.t.v.m. at the junction of these resistors and the hot lead at point X, below the discriminator transformer in Fig. 1.

Adjust the discriminator transformer for zero reading on the meter. The discriminator is then correctly aligned. Now repeat the alignment process. For

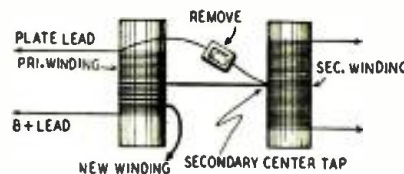

Fig. 3—The ratio detector winding details. more detailed information, see the article on page 30 of this issue.

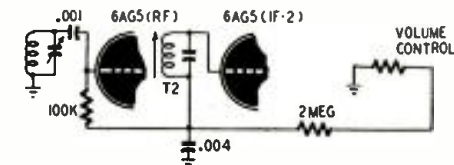

Fig. 4—A.v.c. applied to r.f. and last i.f.

The builder can often persuade a local serviceman to permit the use of a signal generator at his shop for aligning the tuner. In the event no signal generator is available, the alignment process becomes complex and perhaps impossible. Possibly a station could be tuned in and the extremities of the band then approximated, if the i.f.'s are aligned with a 10.7-mc signal.

FM DISCRIMINATOR CIRCUITS

Most FM circuits parallel their corresponding AM equivalents. The FM discriminator, or detector, introduces some totally new features.

By **DOUGLAS H. CARPENTER**

FREQUENCY modulation has today stepped into the limelight both in its own right, and as the sound portion of television transmission. Successful servicing of this equipment requires a thorough knowledge of circuit operation. The visual system of alignment with a cathode-ray oscilloscope and a sweep generator has been covered in recent articles. This method is the accepted way to do a fast, accurate job. In addition to possessing the above equipment the serviceman should have a good working knowledge of the methods employed to convert the frequency-modulated radio signal into the final usable audio. If these circuits are understood, troubles pointed out by the oscilloscope may be more readily located.

The r.f. and mixer stages of an FM receiver do not differ basically from those of a normal AM set. Referring to the schematic of the popular *Pilotuner* we see that the circuit is similar to that of a normal broadcast receiver right up to the detector circuit. This particular unit is a complete, well-designed FM receiver (lacking only the audio system) and is representative of the type of circuit that the serviceman may expect to encounter.

The r.f. and i.f. sections of the receiver must pass a 200-kc band width without too much amplitude variation. This is no problem for the r.f. amplifier, as it is not very selective in terms of 200 kc when operating throughout the high-frequency FM band. Maximum gain is desirable in this stage, however, to keep the signal-to-hiss ratio at low signal levels high.

The i.f. amplifiers must pass this same 200 kc while operating at a much lower frequency. The *Pilotuner* for instance has a center i.f. of 10.7 mc. It is necessary to broaden the natural sharp response of the i.f. parallel resonant circuits to accommodate this 200 kc band. These circuits may be shunted by resistors, or coils of low Q may be used to obtain a more or less flat top response. Another system uses critically-coupled dual i.f. transformers. An amplitude loss of not more than 2:1 at points 75 kc either side of the resonant center frequency is considered satisfactory response.



The *Pilotuner*, a typical standard FM tuner.

Alignment of these amplifiers requires an FM sweep generator and a good oscilloscope. It is perfectly possible to align a FM receiver with an AM generator and output meter only, but it

takes too much time to be practical. As a representative case the *Pilotuner* was aligned by a qualified man using the tedious AM generator-output meter system. It took more than half an hour. A recheck with a sweep generator and a scope showed slight lack of symmetry of both the i.f. and detector patterns. The set was then aligned in five minutes with the sweep generator and scope.

FM limiter circuits

The limiter-discriminator was the first popular system of FM demodulation. This type of receiver is not manufactured as extensively today as the ratio detector type. It may be found in higher-priced receivers, and it requires a greater number of stages to guarantee immunity from noise.

The limiter makes certain that AM noise which may be present with the FM signal is removed before the signal reaches the discriminator (detector). This is done by operating a tube or tubes at low plate and screen voltages so that they saturate easily (are operated to full output with a low value of grid signal drive). Thus the signal which reaches the discriminator is of constant amplitude. The two-stage or cascaded limiter is superior in that it will reach saturation (allow no further change in plate current) with lower grid signal drive. This allows noise-free reception of weaker signals. Noise variations of course can be reproduced as audio if the input signal is too small. The limiter system would not then function properly, as it would not be driven hard enough to saturate. This suggests the use of sharp cutoff tubes in the limiter circuits and high gain in the i.f. system.

The FM discriminator

The discriminator is the detector of the FM set. It follows the limiters, and its purpose is to convert a signal which is varying in frequency into a usable audio voltage. Fig. 1 is the schematic of a back-to-back phase-shift discriminator. If the primary circuit L1-C1 is tuned to the resonant frequency it looks like a pure resistance. The voltage fed to the secondary (L2-L3-C2) is made up of two parts. The first is the voltage across the secondary due to inductive coupling, and the second that which is fed to the secondary center tap through Cc. The phase relations of these two voltages are such that the currents produced by rectification in the two diodes flow through the load circuit (R1-C3-R2-

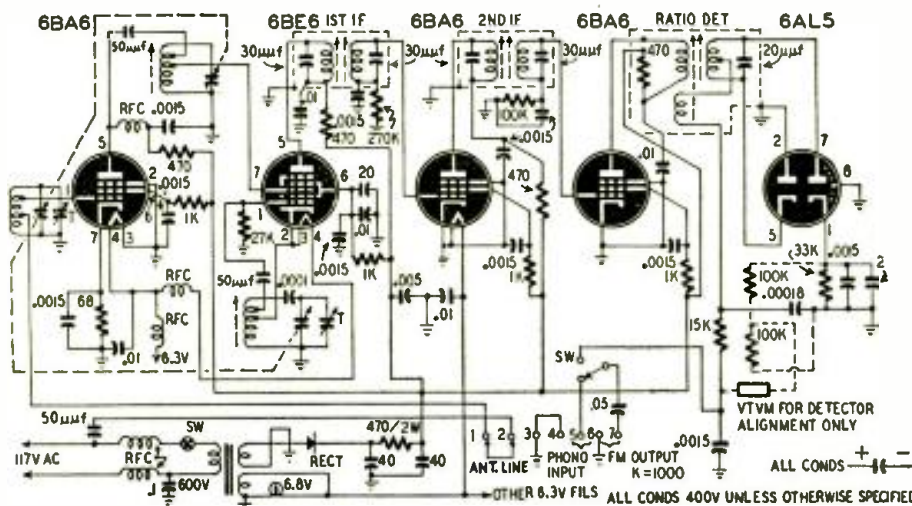

Circuit of the *Pilotuner* referred to above. (Condensed from *RADIO-CRAFT*, September, 1947)

C4) from opposite sides, and buck each other out. The net result is that no voltage appears at the audio terminals.

When modulation is applied to the carrier its frequency shifts above and below the resonant center frequency. If the carrier changes from resonance to a higher frequency the input circuit looks capacitive, and the induced secondary current leads the voltage. This shift in phase causes the current produced by the inductive coupling to combine with that fed to the secondary through Cc in such a way that one diode has more voltage applied to it than the other. The rectified current of this diode increases, while that of the other decreases. The currents in the secondary load circuit are no longer equal, and an audio voltage is produced. If the carrier changes to a frequency lower than resonance the input circuit looks inductive, and the current lags the voltage. In this case the other diode has more voltage applied to it, and the complete load circuit has a voltage across it in the opposite direction to that of the first instance.

The frequency of the audio voltage depends on the rate the carrier is shifted above and below the resonant frequency, and the magnitude depends on how far the carrier is shifted from resonance, as this determines the amount of current unbalance in the load circuit.

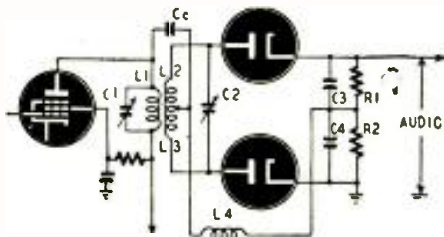

Fig. 1—Back-to-back (Foster-Seeley) circuit.

The width of the frequency band that may be passed without amplitude change depends upon the Qs of the respective coils and the degree of coupling between them. The closer the coupling and the lower the Q, the wider the linear response. The audio voltage difference depends, however, upon the amount of voltage applied to the diodes, and it is desirable to keep the Qs as high as possible, and passing no more than the frequency excursion required.

Since the discriminator responds not only to changes in frequency but also in magnitude of the applied voltage, it is sensitive to amplitude variations such as noise. If a carrier causes the voltage across the two load resistors to be +10 volts across one, and -10 volts across the other, no voltage will be developed across the audio terminals.

If the carrier shifts away from the resonant frequency a certain number of kilocycles the voltage across one resistor will increase to +15 volts, while that across the other will be -5 volts. The voltage delivered to the audio system is then +10 volts. If the carrier received were twice as strong the voltages would be 30 and 10, and the audio signal would be twice as great. This system therefore is rarely used without preceding limiters to wash out undesirable

amplitude variations that come in with the received signal.

The ratio detector

The ratio detector is a discriminator that requires no preceding limiters. It is therefore not necessary to build up the input signal to as high a level as would be necessary to insure saturation in the limiter-discriminator receiver just discussed. Less i.f. amplification is required, and no limiter stages are needed. The production cost of this type of receiver is much less than the limiter-discriminator type, and the ratio detector is used in many lower-priced sets.

The discriminator circuit responds to a change in the average amplitude of the carrier. The voltages developed across the load circuit in the example just given were proportional to the applied signal, but note that the ratios of these voltages were the same. In the first case the voltages across the two load resistors were 5 and 15, or a ratio of 3:1. In the second instance the voltages were 30 and 10, but the ratio was still 3:1. The ratio detector works on changes of this ratio between the voltages developed across both halves of the load circuit. Because of this it is insensitive to amplitude change.

The ratio detector (Fig. 2) works on the principle of separating a fixed d.c. voltage into two parts. The ratio between these two voltages is the ratio of the voltages applied to the separate diodes. This voltage difference is caused by the change in carrier frequency previously explained.

The capacitors C3 and C4 are of equal value, and together with R1 and C2 form the diode load circuit. The rectified currents of the two diodes are in series in this case and create a voltage drop across R1. The voltage developed across this resistor depends on the average strength of the applied signal. Capacitor C2 is large and is an effective bypass for audio variations. The Pilotuner uses an additional small bypass shunted across this high-value condenser to prevent the larger one from acting like an inductor at higher frequencies.

At resonance the current will flow around the series circuit and there will be voltage drop across R1. No voltage will be fed to the audio system, because the ratio of the voltages across C3-C4, is 1:1. If the carrier deviates from resonance more voltage will be applied to one diode than the other, and the ratio of the voltages across C3-C4 no longer will be equal. The total voltage across the load circuit has not changed, but simply the ratio of the voltages across C3-C4. This is realized as useful audio output. The total voltage developed across R1 of course depends on the average strength of the carrier applied. The voltage at the top end of this resistor therefore makes an excellent source of a.v.c.

The large capacitor that shunts the load resistor is called the stabilizing condenser, and serves an additional purpose. A separate variation of the proper phase and amplitude could heterodyne to zero the FM signal itself. If this hap-

pened no voltage would be applied to the diode input circuit, and conduction would be stopped momentarily. The large stabilizing condenser has a charge established across it and has a relatively long time constant. This tends to hold the audio output at the last average level, and the disturbance would not be noticeable to the listener. This detector would not be effective for interference of long duration that satisfied the above requirement. Complex voltage of this type is rare indeed, however.

Summing up the advantages of the two systems, it may be said that the limiter-discriminator type of FM set is slightly superior to the ratio detector system, but requires a greater number of stages for the same practical effect. The ratio detector is found in the majority of currently produced sets because of its lower cost. This conforms with the present policy of manufacturers to produce large numbers of FM receivers at a reasonable price.

An entirely different system of FM detection, employed by Philco, uses a weakly oscillating tube. A heptode specially designed for the work, it has two grids. One of these is the grid of the oscillator circuit; the input signal from the i.f. amplifier is applied to the other.

An oscillator has a well-known tendency to "lock in" with (follow the frequency of) another oscillator tuned near its frequency. Oscillating tubes have another tendency even better known to amateurs. Their frequency varies with variations of plate current. This type of

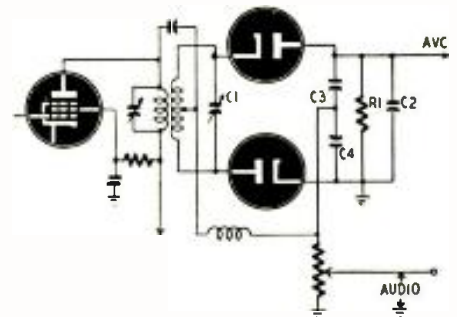

Fig. 2—Circuit of the common ratio detector.

frequency modulation is a very undesirable feature in simple AM transmitters, and one that the ham dislikes.

These two old and heretofore harmful features were used to produce a detector of frequency variations. A circuit (see Fig. 1, page 24) was devised which would increase both these tendencies. The oscillator is so designed that it locks in with and follows faithfully the frequency variations of a relatively small signal applied to its input grid.

The second feature was used in reverse. Changes in the oscillator's frequency are made to produce changes in the plate current. Thus the detector circuit receives a frequency-modulated signal and puts out an amplitude-modulated one.

Other methods have been and are being used to detect FM signals (such as slope detection with superregeneration) but the above are the most important systems, and practically the only ones the repairman will meet.

FM Receiving Antennas

By H. W. SECOR

BEST reception on FM is possible only with an outside antenna. The indoor antenna is more liable to pick up interference from power

For a more accurate calculation, use a correction factor of 7.5% for 98 mc and 3/8-inch diameter tubes or rods for the dipole.

The factor varies with the frequency and the diameter of the antenna elements.

The ordinary simple dipole does not have an even response over the 88—108-mc FM band. A *broad-band* antenna is needed for tuning over the wide frequency range. The *folded dipole*, illustrated in Fig. 3, has been widely adopted for FM because of its broad frequency response.

The frequency response of a simple dipole can be broadened simply by overlapping the inner ends of the two elements, as shown in Fig. 4. The dipole elements are made slightly longer than 1/4 wave length. This extra length makes the antenna inductive. The inductance is compensated for by introducing a capacitance, created by overlapping the inner ends of the tubes.

The plastic twin-lead usually gives very satisfactory results if it is carefully installed and kept away from metal tanks and pipes. To avoid interference pickup, the flat line is sometimes given a twist of about one turn per foot. Some manufacturers supply antennas with center impedances as low as 14 ohms. These must be matched to the (usually) 300-ohm input of the receiver. A simple matching section may be computed and installed as shown in Fig. 5.

Let us assume these factors for an example: Frequency to which antenna is to tune, 98.75 mc; impedance of transmission line, 300 ohms; input impedance of receiver, 300 ohms.

The matching section is a short lead (about 1/4 wave length long), inserted between the antenna and the 300-ohm transmission line. The impedance of the matching section is equivalent to the square root of the product of the two impedances to be coupled, or

$$\text{Impedance of matching lead} = \sqrt{14 \times 300} \text{ or } \sqrt{4200} = 64.9 \text{ ohms.}$$

A choice of three different impedance lines is available: 75 ohms, 150 ohms, and 300 ohms. The nearest value in this case is the 75-ohm line.

To compute the length of 75-ohm line required for the matching section, we use the following formula:

$$L \text{ (inches)} = \frac{11811 \times Y}{f \text{ (mc)} \times 4}$$

The value of Y is chosen from the following tabulation: Y for 75-ohm matching section = 0.69; for 150 ohms, Y = 0.77; for 300 ohms, Y = 0.82. F is the antenna frequency in mc. Substituting 0.69 in the formula gives: L

$$\text{(inches)} = \frac{11811 \times 0.69}{98.75 \times 4} = 20.63.$$

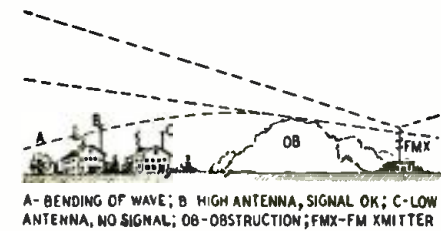

Fig. 1—Line-of-sight may be exceeded by FM.

lines and electrical apparatus, and generally delivers a weaker signal to the input terminals of the receiver.

The higher the FM antenna can be erected, the stronger are the signals, in most cases. If the antenna is low, it may be impossible to receive all the stations in the area. FM signals follow the line-of-sight to a great extent, and the receiving antenna should therefore be as high as possible. There is some bending of the signal due to refraction (Fig. 1). This accounts for satisfactory reception of FM programs at distant locations, even when the receiving antenna is not as high as theory might demand.*

The receiving antenna should be tried in several different locations. Sometimes moving it from one end of a roof to the opposite end spells the difference between poor and good reception. Flexible indoor antennas, when used, can be tested in a number of different positions—under the carpet, on the wall (hidden behind a picture), etc. Keep all FM antennas away from metal masses, metal pipes, and electric wires.

Simplest FM antenna

The simplest FM antenna is the dipole (Fig. 2). It is usually cut to resonate at 98 mc, the center of the FM band. The length of the whole dipole is 1/2 wave length at 98 mc, or 56.7 inches. Each leg of the dipole is one-half this or 28.3 inches.

For general purposes the half-wave length in feet is found from the formula

$$L = \frac{492 - 6\%}{f}$$

where f is the frequency in mc. The 6% corrects for effects due to the capacitance added by the insulators at the ends of the dipole.

quency in mc. The 6% corrects for effects due to the capacitance added by the insulators at the ends of the dipole.

*"Television and FM Antennas," H. W. Secor, RADIO-CRAFT, January, 1948.

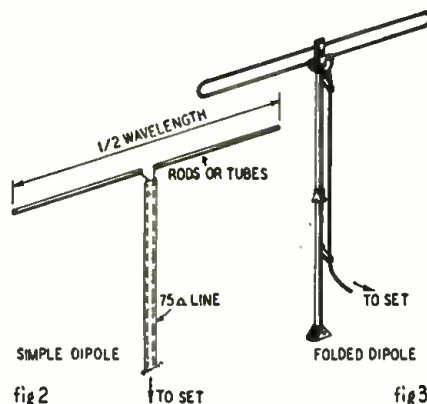

fig 2 fig 3
The simple and folded dipole.

Impedance matching

The average simple dipole has approximately 75 ohms of impedance at the center, at its resonant frequency. The impedance of a folded dipole is about 300 ohms. Since the average FM receiver has an input impedance of 300 ohms (RMA standard), the folded dipole can easily be matched to the receiver with a 300-ohm transmission line. A 75-ohm antenna might be coupled to the receiver (300-ohm input impedance) through a 75-ohm co-axial cable. An impedance matching network should be installed between the end of the co-axial cable and the receiver. Co-axial cable has the advantage of being shielded and not subject to interference pickup, as is the case with the twin-lead flat plastic line.

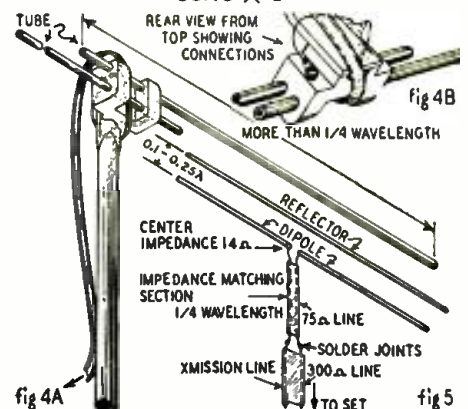

Fig. 4—Overlapping to broaden band.
Fig. 5—A dipole antenna with a reflector.

Fig. 5 shows how the matching section is connected between the 14-ohm antenna and the 300-ohm line to the receiver. The joints between the 75- and 300-ohm lines must be soldered and taped well to protect them against the weather.



Fig. 6—A sensitive and directional antenna.

The directional characteristic of the folded dipole can be improved by adding a reflector. The impedance is somewhat lower (approximately 250 ohms) when the reflector is about 1/4 wave length from it. It is common to match this combination to a 300-ohm transmission line. The small mismatch does not interfere with a satisfactory signal pickup. It is common to space the reflector about 0.15 wave length behind the antenna.

If a *director* element is added to a folded dipole, the directional pattern is still further sharpened—an aid in cases where interference is severe. Since these parasitic elements make the antenna frequency-sensitive and cause response over a narrow band, they are not the best solution of the antenna problem.

A folded dipole with a reflector only

represents a good compromise, since it has a fairly sharp pattern, with broad frequency response and easy matching to a 300-ohm line.

At points remote from the transmitter, where greater signal strength is required, the antenna height can be increased. Or an antenna made of two or more dipoles, one above the other, can be used (Fig. 6). There are several types of omnidirectional antennas. One of them, with the elements arranged in the form of a cross is shown in Fig. 7. A quarter-wave matching section usually connects the two dipoles.

Where it is difficult to pick up a sufficiently strong signal from all the desired stations with one antenna, the use of several antennas may be helpful. Several dipoles can be erected at different locations or one below the other, each one facing the desired station. A simple switch or jack-and-plug arrangement permits the operator to connect any one to the receiver. An alternative is to use one antenna which can be rotated. Sometimes the antenna requires tilting at an angle because of changes in the polarization of the high-frequency waves.

Tuning the FM antenna

While FM antenna adjustment is not too critical, care should be taken when it is erected.

Mount the dipole broadside to the transmitting station. Adjust the length of the dipole elements for maximum signal strength, and also the gap between the inner ends of the elements. About 1 to 1 1/2 inches is a common gap length. Experiment with the distance between the reflector and the dipole for best results—about 1/4 wave length is

suitable for FM. If the length of the reflector is adjustable, vary it too for maximum signal.

It is often best to turn the antenna for the strongest possible signal from the *weakest* stations. The strong signals will take care of themselves. Keep the

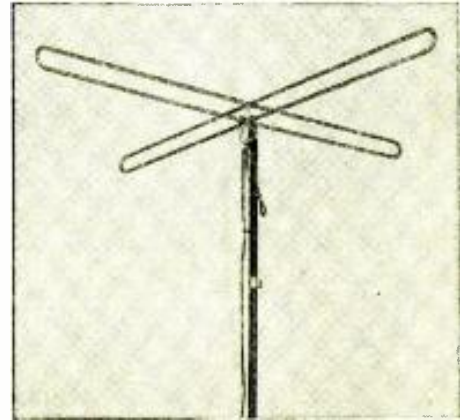

Courtesy Ward Products Co.

Fig. 7—An omnidirectional type of antenna.

lead-in cable away from metal tanks and pipes, and support it away from the building, wall and roof with suitable high-frequency insulators. Anchor it in place so it cannot sway in the wind. Bring the cable into the building through suitable insulators. One method is to use a sheet of polystyrene in place of a glass window pane, passing the lead-in through a hole drilled in the center of the polystyrene panel.

Connect a vacuum or other approved type of lightning arrester to the lead-in. Attach the ground wire to the nearest water pipe or a piece of pipe driven into moist earth. Some types of antennas do not require separate lightning arrestors.

DIRECTORY OF FM RECEIVER MANUFACTURERS

- ADMIRAL CORPORATION
3800 Cortland St., Chicago 47
- AIRADIO, INC.
Melrose Ave. & Barry Place, Stamford, Conn.
- AIR KING PRODUCTS CO., INC.
170 Fifty-Third St., Brooklyn 32, N. Y.
- ANDREA RADIO CORP.
27-01 Bridge Plaza North, Long Island City 1, N. Y.
- ANSLEY RADIO CORP.
41 St. Joes Ave., Trenton 9, N. J.
- APPROVED ELECTRONIC INSTRUMENT CORP.
142 Liberty St., New York 6, N. Y.
- A.R.F. PRODUCTS, INC.
7627 Lake St., River Forest, Ill.
- AUTOMATIC RADIO MFG. CO., INC.
122 Brookline Ave., Boston 15, Mass.
- BELMONT RADIO CORP.
5921 W. Dickens Ave., Chicago 39, Ill.
- BENDIX RADIO
East Joppa Road, Baltimore 4, Md.
- BROOKS ELECTRONIC LABORATORIES
621 Main St., Waltham, Mass.
- BROWNING LABORATORIES, INC.
742-750 Main St., Winchester, Mass.
- BRUNSWICK RADIO & TELEVISION
244 Madison Ave., New York 16, N. Y.
- COLLINS AUDIO PRODUCTS CO.
P.O. Box 368, Westfield, N. J.
- COLONIAL RADIO CORP.
254 Rano St., Buffalo 7, N. Y.
- CROSLEY CORP.
1329 Arlington St., Cincinnati 25, Ohio
- DeWALD RADIO MANUFACTURING CORP.
440 Lafayette St., New York 3, N. Y.
- DONGENE LABORATORIES, INC.
95 Van St., New York, N. Y.
- DuMONT LABORATORIES, INC.
2 Main Ave., Passaic, N. J.
- EDWARDS FM RADIO CORP.
168 Washington St., New York 6, N. Y.
- ELECTRICAL REPRODUCTIONS CO.
1644 N. Ada St., Chicago 22, Ill.
- ELECTRO-TONE CORP.
221 Hudson St., Hoboken, N. J.
- EMERSON RADIO & PHONOGRAPH CORP.
111 8th Ave., New York 11, N. Y.
- ESPEY MANUFACTURING CO., INC.
528 E. 72d St., New York 21, N. Y.

- FADA RADIO & ELECTRIC CO., INC.
30-20 Thomson Ave., Long Island City 1, N. Y.
- FARNSWORTH TELEVISION & RADIO CORP.
3700 E. Pontiac St., Fort Wayne 1, Ind.
- FISHER RADIO CORP.
41 E. 47th St., New York 17, N. Y.
- FINCH TELECOMMUNICATIONS, INC.
4th & Virginia Sts., Passaic, N. J.
- FREED RADIO CORP.
200 Hudson St., New York 13, N. Y.
- GAROD RADIO CORP.
70 Washington St., Brooklyn 1, N. Y.
- GENERAL ELECTRIC CO.
Electronics Park, Syracuse 1, N. Y.
- THE HALLICRAFTERS CO.
4401 W. Fifth Ave., Chicago 24, Ill.
- HOFFMAN RADIO CORP.
3761 S. Hill St., Los Angeles 7, Calif.
- HOUSTON RADIO & TELEVISION CO.
1612 N. Main St., Houston 9, Texas
- HOWARD RADIO CO.
1735 Belmont Ave., Chicago 13, Ill.
- INTERNATIONAL DETROLA CORP.
Beard & Chaffield Aves., Detroit 9, Mich.
- LEAR, INC.
110 Ionia Ave., Grand Rapids 2, Mich.
- LEWYT CORP.
60 Broadway, Brooklyn 11, N. Y.
- THE MAGNAVOX CO.
Ft. Wayne 4, Ill.
- MAJESTIC RADIO & TEL. CORP.
900 N. State St., Elgin, Ill.
- JOHN MECK INDUSTRIES, INC.
Liberty St., Plymouth, Ind.
- MEISSNER MANUFACTURING DIVISION
MAGUIRE INDUSTRIES, INC.
Bellmont & 7th St., Mt. Carmel, Ill.
- MINERVA CORP. OF AMERICA
238 William St., New York 7, N. Y.
- MOTOROLA, INC.
4545 Augusta Blvd., Chicago 51, Ill.
- NATIONAL CO., INC.
61 Sherman St., Malden 48, Mass.
- NOBLITT-SPARKS INDUSTRIES, INC.
13th St. & Big Four RR, Columbus, Ind.
- OLYMPIC RADIO & TELEVISION, INC.
34-01 38th Ave., Long Island City 1, N. Y.

- PHILCO CORP.
Tioga & C. Sts., Philadelphia 34, Pa.
- PILOT RADIO CORP.
37-06 36th St., Long Island City 1, N. Y.
- RCA VICTOR DIVISION
Camden, N. J.
- REL: RADIO ENGINEERING LABS., INC.
35-54 36th St., Long Island City 1, N. Y.
- RADIO TELEVISION PRODUCTS CORP.
Grass Lake, Mich.
- RAYTHEON MANUFACTURING CO.
55 Chapel St., Newton 58, Mass.
- REMLER COMPANY, LTD.
2101 Bryant St., San Francisco 10, Calif.
- SCOTT RADIO LABS., INC.
4541 N. Ravenswood Ave., Chicago 44, Ill.
- SENTINEL RADIO CORP.
2100 Dempster St., Evanston, Ill.
- SONORA RADIO & TEL. CORP.
325 N. Hoyne Ave., Chicago 2, Ill.
- THE SPARKS-WITHINGTON CO.
Jackson, Mich.
- STEWART-WARNER CORP.
1826 Diversey Parkway, Chicago 4, Ill.
- STROMBERG-CARLSON CO.
100 Carlson Rd., Rochester 3, N. Y.
- SYMPHONIC RADIO & ELECTRONIC CORP.
292-298 Main St., Cambridge 42, Mass.
- TELEVOX, INC.
451 South 5th Ave., Mt. Vernon, N. Y.
- TEMPLEONE RADIO MFG. CORP.
100 Garfield Ave., New London, Conn.
- VIEWTONE TELEVISION & RADIO CORP.
81 Willoughby St., Brooklyn 1, N. Y.
- WARWICK MFG. CORP.
4640 W. Harrison St., Chicago 44, Ill.
- WATTERSON RADIO MFG. CORP.
P.O. Box 840, 2700 Swiss Ave., Dallas 1, Texas
- WELLS-GARDNER & CO.
2701 N. Kildare Ave., Chicago 39, Ill.
- WESTINGHOUSE ELECTRIC CORP.
2519 Wilkens Ave., Baltimore 3, Md.
- WILCOX-GAY CORP.
Charlotte, Mich.
- ZENITH RADIO CORP.
6001 Dickens Ave., Chicago 39, Ill.

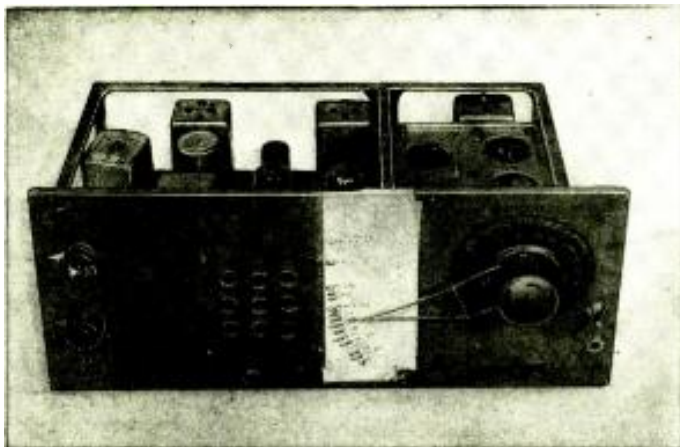

Left, a front view of the converted set. Note the construction of the dial. Below, under-chassis view. R.f. section is on right side.

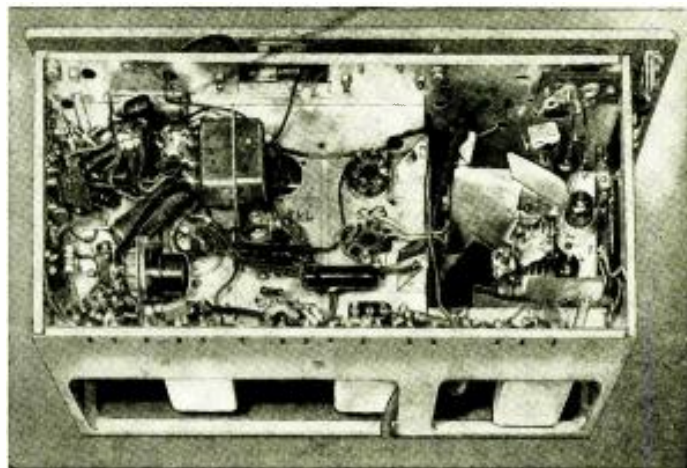

FM Receiver From War Surplus Radio BC-624

By **ROBERT C. PAINE**

FM reception is possible with several surplus sets. The author tells how to convert the BC-624 receiver.

THE BC-624 is still one of the most popular surplus items on the market. It is well liked by amateurs and experimenters who have converted it for receiving AM signals on the 2-meter band. (Detailed instructions for converting the BC-624 for 2-meter reception were given by Mr. L. W. May, W5AJG, in the September, 1947, issue of RADIO-CRAFT. He described the conversion of the companion transmitter in the April, 1947, issue.) In this article we will show how it can be converted with little effort to a standard wide-band FM receiver.

This set is available separately or as a component of the SCR-522—a receiver and transmitter combination designed

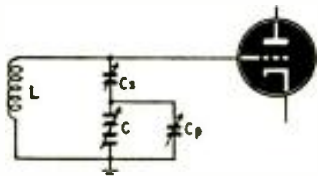

Fig. 1—Trimmers and padders adjust tracking for use on the 100- to 156-mc band. The tube line-up is as follows: 9003 (VT-203) r.f. amplifier; 9003 mixer; 9002 (VT-202) harmonic amplifier; 12AH7 (VT-207) crystal oscillator and squelch relay control tube; three 12SG7 (VT-209) 12-mc i.f. amplifiers; 12C8 (VT-169) second detector; a.v.c. and first a.f. amplifier; and a 12J5 (VT-135) second a.f. amplifier.

There are several versions of the BC-624. The BC-624-A is one with minor electrical or mechanical improvements. The BC-624-AM is the BC-624-A modified—either in the field or factory—to include an additional tube for delayed a.v.c. and automatic noise limiter cir-

cuits. This tube is mounted under the chassis. The latest model, the BC-624-C, is a scarce item on the surplus market. It uses a 12H6 (VT-214) in an electronic squelch that replaces the mechanical system used in earlier models. Any of these models can be used in making this conversion.

Equipment circuit alterations

If your BC-624 is in a rack with the transmitter, remove it by unscrewing the red-painted screws visible when the rack is out of the cabinet. The next step is to remove the mechanical channel selector which turns the tuning condensers through cams. These cams are fastened with Bristo screws that can be removed with a No. 8 Bristo wrench after the cement that prevents their shaking loose has been removed with carbon tetrachloride.

Remove the a.f. transformer (295) and the plate relay in the mechanical squelch circuit. Take out the crystal mounting strip, the tuning coils, power plug, and terminal strips near the 12C8, 12J5, and 12AH7 tubes. The i.f. amplifier is used as is, with only minor changes, but the second detector and audio system are completely rewired. The 12C8, 12J5, and 12AH7 are replaced with a 6SN7, 6K6, and 6X5, respectively.

There are two variable condensers: one has three gangs, and the other has two. These have split stators and insulated rotors. Each section has a capacitance of approximately 16 to 50 μf which makes them ideal for tuning h.f. circuits.

Assuming a circuit capacitance of 4 μf in parallel with the tuning condenser, we have an available capaci-

tance of 20-54 μf . This has a possible tuning range of $\sqrt{54\mu\text{f}/20\mu\text{f}}=1.64/1$. The FM band, 108 mc to 88 mc, requires a range of 1.23/1. This means that the condenser, as it stands, has an excessive tuning range, which results in more difficult alignment and a more crowded tuning scale. The capacitance ratio is changed with trimmers and padders as shown in Fig. 1, where C is the main condenser, Cp the small parallel trimmer built in on the main condenser, and Cs is a 5-35- μf mica trimmer mounted in series with the coil. Since the entire tuning range of the condenser is actually somewhat less than 90 degrees and the active stations come close together, a tuning dial with an expanded scale is desirable. The author used a planetary type (National) with a long pointer attached to the dial.

The R.F. circuit

The circuit of a BC-624 converted for FM operation is shown in Fig. 2. Signal Corps nomenclature, in parenthesis, and color codes have been entered on the diagram to aid in tracing the circuit. The front end of the set is rewired with the 9002 in the oscillator circuit tuned by the center section of the condenser. Self-supporting coils are used in the antenna, mixer, and oscillator circuits. They are 3/8 inch in diameter and are wound with No. 14 wire. L1 is 2 turns placed about 1/4 inch from the grounded end of L2. L2 has 6 turns, spaced to 15/16 inch; L3 has 6 turns, center tapped and spaced to 7/8 inch. L4 is identical to L2.

The original i.f. transformers were designed for AM circuits, and their band width is too narrow for FM reception. The band width should be 200

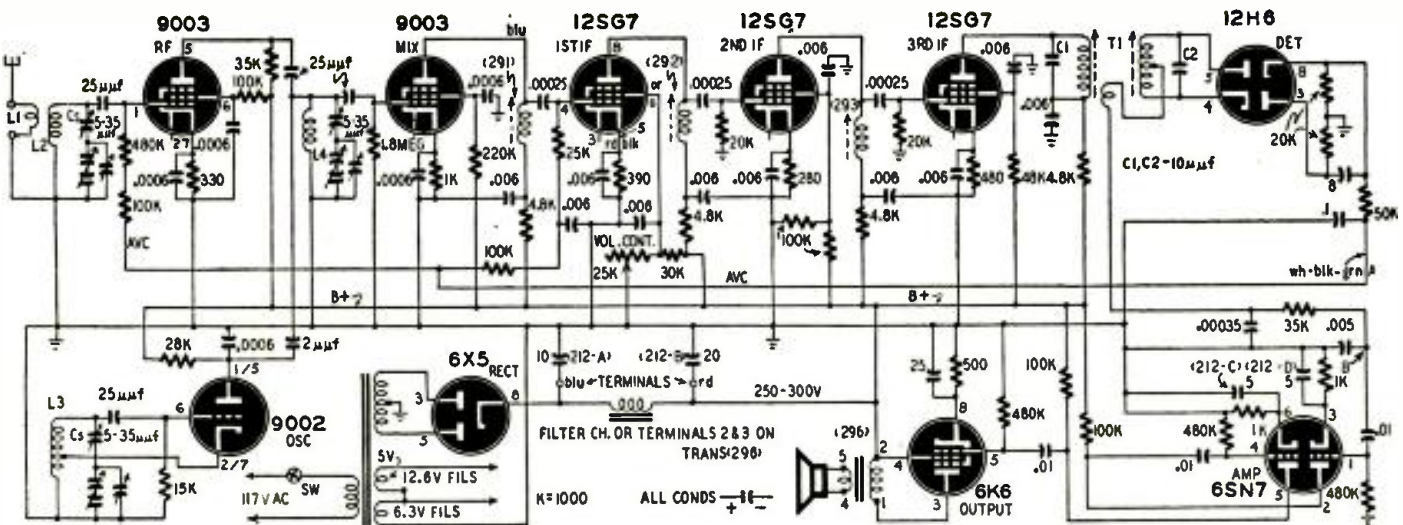

Fig. 2—The schematic. Replacing the 35,000-ohm resistor in the detector circuit with 15,000 ohms will improve high-note reproduction.

to 300 kc. The band can be broadened by using inductive coupling with only one coil of the i.f. transformer, connected as an inductance loaded with a low-resistance grid leak, as shown in Fig. 3. The new parts added are enclosed by dotted lines. The coils are stagger-tuned to different frequencies close to 12 mc to give approximately even gain over a band of 200-300 kc.

A ratio discriminator transformer, T1, must be built to take the place of the 4th i.f. transformer (294). For this purpose the author rewound a 455-kc, iron-core i.f. transformer which happened to be available. The two coils of the BC-624 i.f. transformers are wound on separate, rigidly spaced forms, and it is impractical to vary their coupling. The arrangement of the discriminator coils and the connections for the ratio detector are shown in Fig. 4. The number of turns and values of tuning condensers C1 and C2 will vary, depending on the particular coil form used. The primary and secondary windings should each be tunable to 12 mc. If you follow the specifications given below, C1 and C2 will be about 10 μf each.

A 1/2-inch form was used for the discriminator transformer. The primary winding has 19 turns and the tertiary has 4 turns. The secondary is a bifilar winding made by doubling a length of wire and winding 16 turns on the form, keeping the turns close together and parallel. The doubled end of the wire is the center tap, and the open ends are the ends of the secondary. All coils in the discriminator transformer are wound with No. 30 enameled wire.

The audio system follows conventional lines and is easy to construct. It has a 3-stage circuit. A 6SN7 is connected as a resistance-coupled cascade amplifier working into the 6K6 pentode power amplifier. It is shown in the lower right corner of the complete diagram in Fig. 2. The original output transformer (296) was not designed to handle power so it may be necessary to use a standard output transformer designed to match the 6K6 if good quality is expected. The d.c. output of the detector is connected to the original a.v.c. lead (identified as

a white-black-green wire), since it is desirable to retain this feature of the original circuit.

The power supply

Since the i.f. tubes have 12-volt filaments, we used an ordinary receiver transformer with 6.3-volt and 5-volt filament windings connected in series-aiding to produce 11.3 volts, which will suffice for the 12-volt tubes. The 6.3-volt terminals can still be left available for the 6.3-volt tubes. A cathode-type rectifier, such as the 6X5, can be used for the B-supply. A choke and condensers of standard values or components of the set can be used in the power-supply filter circuit. The output transformer (296) has a choke winding between terminals 2 and 3 that can be used with condensers (212-A) and (212-B) in the metal-cased condenser can. This can also contain two 5- μf , low-voltage units that were used to bypass the cathodes of the 6SN7. You can mount the power transformer in the space formerly occupied by parts that were removed.

Aligning the set

The set can be best aligned with an FM signal generator; however an AM type will do. To align the discriminator transformer, the AM generator is connected to the grid of the third i.f. tube and a high-resistance or electronic d.c. voltmeter is connected to the a.v.c. lead at A (Fig. 2). The primary is then tuned for maximum output at 12 mc. The meter is transferred to point B and the secondary tuned for zero output at 12 mc. When the signal is shifted away from 12 mc the d.c. reading will increase to a maximum value and then drop off, reversing polarity and going through zero as the frequency goes from above to below 12 mc. These maximum values should be equal. There is some interaction between these adjustments so it may be necessary to repeat them.

To align the tuning unit and the i.f. stages with an AM generator, the ratio detector is temporarily converted into an amplitude-modulation detector by grounding one end of the discriminator transformer through a small condenser

and connecting an output meter to the audio output. The i.f. transformers are then stagger-tuned to transmit a band 200 to 300 kc wide at 12 mc. For the r.f. unit, C_s (see Fig. 1) is varied in the r.f. and mixer circuits to obtain the desired range (somewhat greater than 88-108 mc). (We adjusted the set so the oscillator frequency is 12 mc lower than the

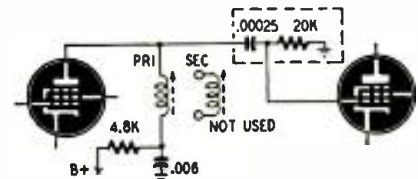
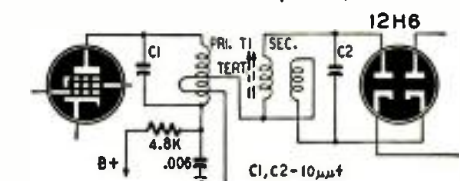

Fig. 3—Coupling inductance in plate circuit. (The secondary is not used for the discriminator signal frequency). The oscillator is tracked at the low-frequency end by adjusting C_s, and at the high-frequency end by adjusting C_p. The coil can be squeezed together or spread apart as required. Alignment is checked by varying the inductance of each coil with a tuning wand. The powdered-iron slug low-

ers the resonant frequency and the copper slug raises it—the condensers or coils must be adjusted according to the indication obtained.



The receiver conversion outlined above results in a reasonably good FM receiver. It is sufficiently sensitive to bring in stations to a distance of about 30 miles away, with only a 3- or 4-foot wire as an antenna.

WANTED: FM SCOUTS

FM is a new art in Radio. Much of it remains to be learned by engineers. The behavior of radio waves in the FM band is still understood imperfectly. According to theory, FM signals should not reach much beyond the horizon. Yet often they do. In some cases extraordinary DX reception has been reported.

RADIO-CRAFT readers can render the radio art a distinct service in reporting such phenomena as well as others, to us regularly. We will publish such information as well as the "FM Scout's" name in this department. Some excellent reports have already been received. Address all letters to FM Department, c/o this magazine.

THE EDITORS

RESPONSE to our last month's call for FM scouts has been encouraging. Several excellent distance reports have been received. A number of others may or may not have been records, but the reports did not give enough information to determine exactly how good the reception was. Reports have also in some cases given the reputed distances (often based on road mileage) to the stations reported, instead of the air-line distance.

Best distance was reported by Jack Wulfmeyer of Valley Park, Missouri, (20 miles southwest of St. Louis). Using a Pilotuner with a Masco 35-watt

amplifier, he has received WKIL-FM, Kankakee, Illinois, and WCSI-FM, Columbus, Indiana. Both these stations are in the order of 250 miles from his location. His antenna is a Ward television folded dipole shortened to tune to the FM band, and he is "atop the highest point in St. Louis County."

Thomas Gray of Arlington, Virginia, reports reception of WCBF-FM and WGYN, New York City, about 215 miles away, on a pre-war G-E converted to the new band. Another long-range report was filed by Lincoln A. Wood of Ayer, Massachusetts. He reports that W2XEA, Alpine, New Jersey, and

WGHF of New York City come in almost nightly, sometimes with very strong signals. The distance is approximately 190 miles. N.Y.C. stations WCBF-FM, WGYN, WNBC-FM and WNYC-FM are also heard occasionally, and WTRI, Troy, and WGFN, Schenectady, are heard practically every night.

To make FM reports really valuable, scouts should furnish the following information:

1. Make and model of receiver(s) used.
2. Type of aerial and transmission line and its height above ground.
3. Airline distance to the transmitters whose signals are received.
4. Time of reception and duration of period in which signals are received.

Please get all the above dope into your next report! Only then can information be gathered which will not only be of real interest, but may also add to the world's knowledge of the behavior of very-high frequency radio waves.

STATION	LOCATION	FREQUENCY (mc)	STATION	LOCATION	FREQUENCY (mc)	STATION	LOCATION	FREQUENCY (mc)
KAGH-FM	Pasadena, Calif.	98.3	KOMB	Des Moines, Iowa	92.3	WAGE-FM	Syracuse, N. Y.	98.5
KAKC-FM	Tulsa, Okla.	94.9	KONG	Alameda, Calif.	104.9	WAIR-FM	Winston-Salem, N. C.	93.1
KALB-FM	Alexandria, La.	96.9	KONO-FM	San Antonio, Texas	92.9	WAJL	Flint, Mich.	107.1
KALW	San Francisco, Calif.	91.7	KOPP-FM	Ogden, Utah	103.9	WAJR	Morgantown, W. Va.	99.3
KAMT-FM	College Station, Texas	94.5	KOPY	Houston, Texas	98.5	WAKR-FM	Akron, Ohio	97.5
KARM-FM	Fresno, Calif.	101.9	KOZY	Kansas City, Mo.	98.1	WAMS-FM	Wilmington, Del.	96.1
KBEE	Modesto, Calif.	103.3	KPDR-FM	Alexandria, La	99.7	WAPO-FM	Chattanooga, Tenn.	94.7
KBIX-FM	Muskogee, Okla.	98.5	KPFF-FM	Portland, Ore.	97.1	WARM-FM	Scranton, Pa.	105.7
KBMT	San Bernardino, Calif.	99.9	KPNI	Palo Alto, Calif.	101.7	WASH	Washington, D. C.	97.1
KBTR	Minneapolis, Minn.	98.5	KPOR	Riverside, Calif.	97.5	WATG-FM	Ashland, Ohio	101.3
KBUR-FM	Burlington, Iowa	92.9	KPRA	Portland, Ore.	95.5	WATL-FM	Atlanta, Ga.	97.5
KCLI	Los Angeles, Calif.	105.1	KPRC-FM	Houston, Texas	102.9	WAYS-FM	Charlotte, N. C.	107.7
KCMC-FM	Texarkana, Texas	92.5	KQV-FM	Pittsburgh, Pa.	98.1	WBAB-FM	Atlantic City, N. J.	100.7
KCRA-FM	Sacramento, Calif.	96.1	KQW-FM	San Francisco, Calif.	103.7	WBAM	New York, N. Y.	98.7
KCRK	Cedar Rapids, Iowa	96.9	KRBA-FM	Lufkin, Texas	95.5	WBBB-FM	Burlington, N. C.	101.1
KCRW	Santa Monica, Calif.	89.9	KRBC-FM	Abilene, Texas	96.9	WBBM-FM	Chicago, Ill.	97.1
KCVN	Stockton, Calif.	91.3	KRCC	Richmond, Calif.	104.5	WBCA-FM	Schenectady, N. Y.	101.1
KDKA-FM	Pittsburgh, Pa.	92.9	KRFM	Fresno, Calif.	93.7	WBCM-FM	Bay City, Mich.	96.1
KDYL-FM	Salt Lake City, Utah	98.7	KRIC-FM	Beaumont, Texas	99.5	WBEN-FM	Buffalo, N. Y.	106.5
KECA-FM	Los Angeles, Calif.	95.5	KRJM	Santa Maria, Calif.	103.1	WBEZ	Chicago, Ill.	91.5
KEAO-FM	Las Vegas, Neb.	103.9	KRKO-FM	Los Angeles, Calif.	96.3	WBGE-FM	Atlanta, Ga.	95.5
KERN-FM	Bakersfield, Calif.	94.1	KRLD-FM	Dallas, Texas	92.5	WBGO	Newark, N. J.	91.1
KFAB-FM	Lincoln, Nebr.	97.9	KROC-FM	Rochester, Minn.	94.7	WBIB	New Haven, Conn.	100.7
KFAC-FM	Los Angeles, Calif.	104.3	KRON-FM	San Francisco, Calif.	96.5	WBIC	Chicago, Ill.	96.3
KFBK-FM	Sacramento, Calif.	96.9	KRSC-FM	Seattle, Wash.	98.1	WBKY	Lexington, Ky.	91.3
KFI-FM	Los Angeles, Calif.	105.9	KRYM	Eugene, Ore.	90.1	WBML-FM	Macon, Ga.	100.7
KFMB-FM	San Diego, Calif.	101.5	KSBR	San Bruno, Calif.	100.5	WBNN	Beloit, Wis.	107.3
KFMX	Council Bluffs, Iowa	96.1	KSBS	Kansas City, Kans.	105.9	WBNU	Aurora, Ill.	103.9
KFMY	Fort Dodge, Iowa	102.7	KSCJ-FM	Sioux City, Iowa	94.9	WBNY-FM	Buffalo, N. Y.	92.9
KFOR-FM	Lincoln, Nebraska	102.9	KSEI-FM	Pocatello, Idaho	96.5	WBOC-FM	Salisbury, Md.	97.5
KFPW-FM	Fort Smith, Ark.	94.9	KSEO	Durant, Okla.	107.3	WBOE	Cleveland, Ohio	90.3
KFSA	Fort Smith, Ark.	107.7	KSFH	San Francisco, Calif.	94.9	WBOW-FM	Terre Haute, Ind.	101.1
KFSH	San Francisco, Calif.	94.9	KSJO-FM	San Jose, Calif.	95.3	WBOX-FM	Louisville, Ky.	100.7
KFUO-FM	St. Louis, Mo.	104.1	KSL-FM	Salt Lake City, Utah	100.3	WBRE-FM	Wilkes-Barre, Pa.	98.5
KFXD-FM	Nampa, Idaho	101.9	KSPI-FM	Stillwater, Okla.	93.9	WBRL	Baton Rouge, La.	98.1
KFXM-FM	San Bernardino, Calif.	95.1	KSTP-FM	St. Paul, Minn.	102.1	WBT-FM	Charlotte, N. C.	99.9
KFYO-FM	Lubbock, Texas	99.5	KSUI	Iowa City, Iowa	91.7	WBTM-FM	Danville, Va.	97.9
KGAR-FM	Garden City, Kans.	99.3	KTFI-FM	Twin Falls, Idaho	99.7	WBUR-FM	Burlington, Iowa	92.9
KGBS-FM	Harlingen, Texas	95.3	KTOK-FM	Oklahoma City, Okla.	104.3	WBUX	Bradbury Heights, Md.	96.7
KGDM-FM	Stockton, Calif.	92.9	KTRH-FM	Houston, Texas	101.1	WBYS-FM	Canton, Ill.	100.9
KGKB-FM	Tyler, Texas	101.5	KTRN	Wichita Falls, Texas	97.3	WBZF-FM	Boston, Mass.	92.9
KGKL-FM	San Angelo, Texas	94.5	KTSJ	Topeka, Kans.	99.5	WBZA-FM	Springfield, Mass.	97.1
KGLO-FM	Mason City, Iowa	101.1	KTUL-FM	Tulsa, Okla.	97.1	WCAC-FM	Anderson, S. C.	101.1
KGNC-FM	Amarillo, Texas	104.3	KUGN-FM	Eugene, Ore.	99.1	WCAO-FM	Baltimore, Md.	102.7
KGOF-FM	San Francisco, Calif.	106.1	KUOA-FM	Siloam Springs Ark.	105.7	WCAP-FM	Asbury Park, N. J.	107.1
KGPO	Grants Pass, Oregon	96.9	KURV-FM	Edinburg, Texas	104.9	WCAU-FM	Philadelphia, Pa.	98.1
KGW-FM	Portland, Ore.	100.3	KUSC	Los Angeles, Calif.	91.5	WCBS-FM	New York, N. Y.	101.1
KHJ-FM	Hollywood, Calif.	101.1	KVCI-FM	Chico, Calif.	101.1	WCBT-FM	Roanoke Rapids, N. C.	98.5
KIDO-FM	Boise, Idaho	106.1	KVEC-FM	San Luis Obispo, Calif.	99.9	WCEC-FM	Rocky Mount, N. C.	100.7
KIMV	Hutchinson, Kans.	105.7	KVNJ-FM	Fargo, N. D.	92.3	WCFC-FM	Beckley, W. Va.	101.3
KING-FM	Seattle, Wash.	94.9	KVWC-FM	Vernon, Texas	98.7	WCFR	Fall River, Mass.	100.9
KISS	San Antonio, Texas	99.5	KWBR-FM	San Francisco, Calif.	97.3	WCHA-FM	Chambersburg, Pa.	95.5
KIXL-FM	Dallas, Texas	104.5	KWBW-FM	Hutchinson, Kans.	93.1	WCIL-FM	Carbondale, Ill.	100.7
KJBS-FM	San Francisco, Calif.	98.9	KWGS-FM	Tulsa, Okla.	90.5	WCJT	Louisville, Ky.	99.7
KKLA	Los Angeles, Calif.	97.1	KWIL-FM	Albany, Ore.	101.7	WCLO-FM	Janesville, Wis.	99.9
KLCN-FM	Blytheville, Ark.	96.1	KWK-FM	St. Louis, Mo.	99.1	WCMT	Newark, Ohio	100.3
KLOK-FM	San Jose, Calif.	98.5	KWLK-FM	Longview, Wash.	104.3	WCMB-FM	Canton, Ohio	94.9
KLZ-FM	Denver, Colo.	94.1	KXEL-FM	Waterloo, Iowa	105.7	WCNB	Connersville, Ind.	100.3
KMBC-FM	Kansas City, Mo.	100.5	KXLW-FM	Clayton, Mo.	101.1	WCOA-FM	Pensacola, Fla.	98.9
KMBT	San Bernardino, Calif.	99.9	KXOA-FM	Sacramento Calif.	107.9	WCOD-FM	Richmond, Va.	98.1
KMFM	Monroe, La.	104.1	KXOK-FM	St. Louis, Mo.	93.7	WCOH-FM	Newnan, Ga.	92.3
KMPC-FM	Hollywood, Calif.	100.3	KXYZ-FM	Houston, Texas	96.5	WCOL-FM	Columbus, Ohio	92.3
KMUS	Muskogee, Okla.	101.5	KYFM-FM	San Antonio Texas	101.5	WCOU-FM	Lewiston, Me.	93.9
KMYC-FM	Marysville, Calif.	99.9	KYSM-FM	Mankato, Minn.	103.5	WCST	Columbus, Ind.	93.7
KNBC-FM	San Francisco, Calif.	99.7	KYWF-FM	Philadelphia, Pa.	92.5	WCTP	Greensboro, N. C.	98.7
KNX-FM	Hollywood, Calif.	93.1	W2XEA	Alpine, N. J.	92.1	WCST	Cincinnati, Ohio	101.9
KOA-FM	Denver, Colo.	95.7	W2XMN	Alpine, N. J.	44.1	WCTW	New Castle, Ind.	103.1
KOAD-FM	Omaha, Nebr.	92.9	WAAT-FM	Newark, N. J.	94.7	WCVS-FM	Springfield, Ill.	102.9
KOCS-FM	Ontario, Calif.	93.5	WABF	New York, N. Y.	99.5	WDAE-FM	Tampa, Fla.	105.7
KOCY-FM	Oklahoma City, Okla.	94.7	WABX-FM	Harrisburg, Pa.	100.9	WDBQ	Dubuque, Iowa	103.3
KOKX-FM	Keokuk, Iowa	102.7	WACE-FM	Chicopee, Mass.	100.3	WDLB-FM	Marshfield, Wis.	103.9
KOMA-FM	Oklahoma City, Okla.	105.9	WAFM-FM	Birmingham, Ala.	99.5			

(Continued on page 42)

MONEY BACK GUARANTEE — We believe units offered for sale by mail order should be sold only on a "Money-Back-If-Not-Satisfied" basis. We carefully check the design, calibration and value of all items advertised by us and unhesitatingly offer all merchandise subject to a return for credit or refund. You, the customer, are the sole judge as to value of the item or items you have purchased.

The Model 88-A COMBINATION **SIGNAL GENERATOR AND SIGNAL TRACER**

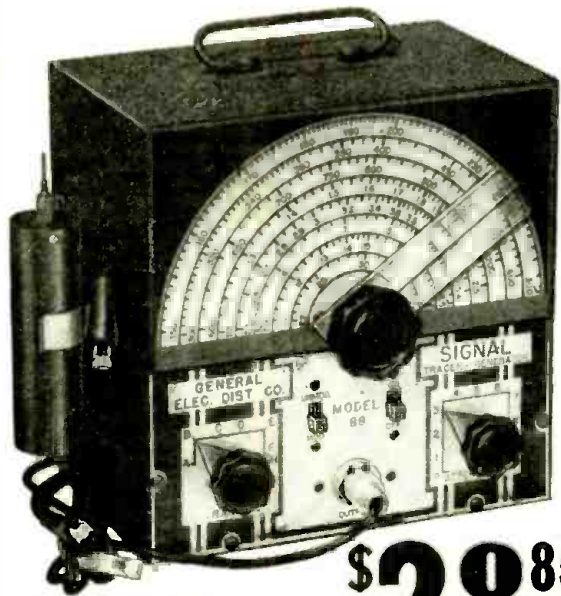

The Model 88 comes complete with all test leads and operating instructions.

ONLY \$28⁸⁵ NET

The ultimate in signal tracing procedure is achieved by the Model 88, for the use of this model, enables you to use either the broadcast signal itself or the signal injected by the Signal Generator. This is especially useful of course when servicing "dead" or "intermittent" receivers. The Model 88 you will find is the greatest time-saver ever provided for by combining a full range Signal Generator and Signal Tracer into one unit the set up time for interconnecting, etc., is entirely eliminated.

Signal Generator Specifications:

- ★ Frequency Range: 150 Kilocycles to 50 Megacycles.
- ★ The R.F. Signal Frequency is kept completely constant at all output levels. This is accomplished by use of a special grid loaded circuit which provides a constant load on the oscillatory circuit. A grounded plate oscillator is used for additional frequency stability.
- ★ Modulation is accomplished by Grid-blocking action which has proven to be equally effective for alignment of amplitude and frequency modulation as well as for television receivers.
- ★ Positive action attenuator provides effective output control at all times.
- ★ R.F. is obtainable separately or modulated by the Audio Frequency.

Signal Tracer Specifications:

- ★ Uses the new Sylvania 1N34 Germanium crystal Diode which combined with a resistance-capacity network provides a frequency range of 300 cycles to 50 Megacycles.
- ★ Simple to Operate—Clips directly on to receiver chassis, no tuning controls.
- ★ Provision is made for insertion of phones of any impedance, a standard Volt-Ohm Milliammeter or Oscilloscope.

The New Model 606 **TUBE & SET TESTER**

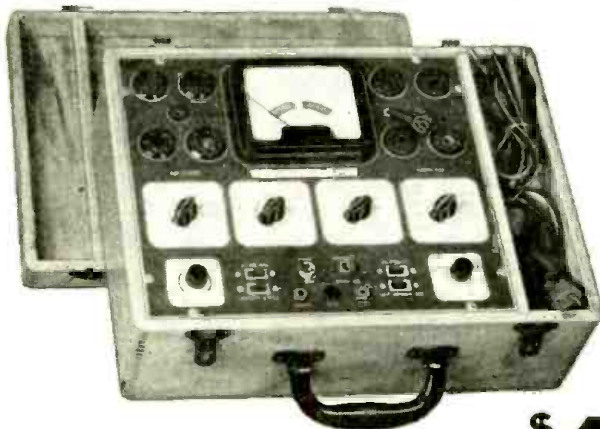

Model 606 comes housed in a beautiful hand rubbed oak cabinet complete with portable cover, test leads, tube charts, and detailed operating instructions—

ONLY \$47.85 NET

A COMPLETE TUBE TESTER

- Tests all tubes including the new post-war miniature loctals such as the 12AT6, 12AU6, 35W4, 50B5, 11723, etc.
- Tests by the well-established emission method for tube quality, directly read on the scale of the meter.
- Tests shorts and leakages up to 3 Megohms in all tubes.
- Tests leakages and shorts of any one element against all elements in all tubes.
- Tests both plates in rectifiers.
- Tests individual sections such as diodes, triodes, pentodes, etc., in multi-purpose tubes.

A COMPLETE MULTI-METER

- 6 D.C. VOLTAGE RANGES:
0 to 7.5/15/75/150/750/1,500 Volts
- 6 A.C. VOLTAGE RANGES:
0 to 15/30/150/300/1,500/3,000 Volts
- 4 D.C. CURRENT RANGES:
0 to 1.5/15/150 Ma. 0 to 1.5 Amps.
- LOW RESISTANCE RANGE:
0 to 2,000 Ohms (1st division is 1/10th of an ohm.)
- 2 MEDIUM RESISTANCE RANGES:
0 to 20,000/200,000 Ohms
- HIGH RESISTANCE RANGE:
0 to 20 Megohms
- 3 DECIBEL RANGES:
-10 to +38 +10 to +38 +30 to +58 D.B.

20% DEPOSIT REQUIRED ON ALL C.O.D. ORDERS

GENERAL ELECTRONIC DISTRIBUTING CO. DEPT. RC-6 98 PARK PLACE,
NEW YORK 7, N. Y.

Complete FM Station List

STATION	LOCATION	FREQUENCY	STATION	LOCATION	FREQUENCY	STATION	LOCATION	FREQUENCY
WDLM	Chicago, Ill.	95.5	WHPE-FM	High Point, N. C.	95.5	WMLL	Evansville, Ind.	94.5
WDNC-FM	Durham, N. C.	105.1	WHTN-FM	Huntington, W. Va.	100.5	WMLN	Mt. Clemens, Mich.	106.3
WDOS-FM	Oneonta, N. Y.	99.1	WHVA	Poughkeepsie, N. Y.	104.7	WMMW-FM	Meriden, Conn.	95.7
WDRC-FM	Hartford, Conn.	93.7	WHYN-FM	Holyoke, Mass.	93.1	WMNE	Boston, Mass.	100.5
WDTR	Detroit, Mich.	90.9	WIBA-FM	Madison, Wisc.	101.5	WMOT-FM	Pittsburgh, Pa.	94.5
WDUL	Duluth, Minn.	92.3	WIBG-FM	Philadelphia, Pa.	94.1	WMRC-FM	Greenville, S. C.	94.9
WDXY	Spartanburg, S. C.	100.5	WIBW-FM	Topeka, Kans.	102.6	WMUN	Muncie, Ind.	104.1
WEAW	Evanston, Ill.	96.7	WIBX	Utica, N. Y.	96.9	WMUR-FM	Manchester, N. H.	95.7
WEAU-FM	Eau Claire, Wis.	94.1	WIL-FM	St. Louis, Mo.	97.3	WMUS-FM	Muskegon, Mich.	100.5
WEBC-FM	Superior, Wis.	92.3	WINC-FM	Winchester, Va.	92.5	WMAM-FM	Neenah, Wisc.	98.5
WEBR-FM	Buffalo, N. Y.	96.9	WINX-FM	Washington, D. C.	96.3	WNAV-FM	Annapolis, Md.	99.1
WEUU-FM	Reading, Pa.	92.9	WIOD-FM	Miami, Fla.	97.3	WNBC-FM	New York, N. Y.	97.1
WEEX	Easton, Pa.	98.3	WIP-FM	Philadelphia, Pa.	93.3	WNBF-FM	Binghamton, N. Y.	100.5
WEFM	Chicago, Ill.	99.5	WIS-FM	Columbia, S. C.	94.5	WNDB-FM	Daytona Beach, Fla.	94.5
WEHS	Chicago, Ill.	97.9	WISE-FM	Asheville, N. C.	102.5	WDR-FM	Syracuse, N. Y.	102.5
WELD-FM	Columbus, Ohio	97.1	WIST	Charlotte, N. C.	104.7	WNLC-FM	New London, Conn.	99.5
WELL-FM	Battle Creek, Mich.	102.1	WITR-FM	Baltimore, Md.	104.3	WNYC-FM	New York, N. Y.	93.9
WENR-FM	Chicago, Ill.	94.7	WIUC	Urbana, Ill.	91.7	WOAI-FM	San Antonio, Texas	102.5
WERC-FM	Erie, Pa.	99.9	WIZZ	Wilkes-Barre, Pa.	103.3	WOHS-FM	Shelby, N. C.	96.1
WESB-FM	Bradford, Pa.	97.5	WJAS-FM	Pittsburgh, Pa.	99.7	WOPI-FM	Bristol, Tenn.	96.9
WEW-FM	St. Louis, Mo.	95.1	WJBC-FM	Bloomington, Ill.	101.5	WOPT-FM	Oswego, N. Y.	104.7
WEWS-FM	Cleveland, Ohio	102.1	WJBK-FM	Detroit, Mich.	93.1	WOTW-FM	Nashua, N. H.	106.3
WEXL-FM	Royal Oak, Mich.	104.3	WJBY-FM	Gadsden, Ala.	103.7	WOWO-FM	Fort Wayne, Ind.	96.1
WFAA-FM	Dallas, Texas	97.9	WJEJ-FM	Hagerstown, Md.	104.7	WPAD-FM	Paducah, Ky.	96.9
WFAH-FM	Alliance, Ohio	101.7	WJEM	Springfield, Ohio	103.9	WPAG-FM	Ann Arbor, Mich.	98.7
WFAS-FM	White Plains, N. Y.	103.9	WJHP-FM	Jacksonville, Fla.	96.9	WPAM-FM	Pottsville, Pa.	95.5
WFBL-FM	Syracuse, N. Y.	93.1	WJJW	Wyandotte, Mich.	103.1	WPDX-FM	Clarksburg, W. Va.	95.1
WFIL-FM	Philadelphia, Pa.	102.1	WJLB-FM	Detroit, Mich.	97.9	WPEN-FM	Philadelphia, Pa.	102.9
WFJS	Freepport, Ill.	102.5	WJLK-FM	Asbury Park, N. J.	94.3	WPIC-FM	Sharon, Pa.	102.9
WFMD-FM	Frederic, Md.	101.5	WJLS-FM	Beckley, W. Va.	99.5	WPLH-FM	Huntington, W. Va.	102.5
WFMI	Portsmouth, N. H.	107.3	WJMC-FM	Rice Lake, Wis.	96.3	WPTL	Providence, R. I.	91.5
WFMJ-FM	Youngstown, Ohio	105.1	WJNO-FM	West Palm Beach, Fla.	98.7	WQAM-FM	Miami, Fla.	94.9
WFML	Washington, Ind.	106.5	WJOB-FM	Hammond, Ind.	92.3	WQDI	Quincy, Ill.	105.1
WFMO	Jersey City, N. J.	103.1	WJPF-FM	Herrin, Ill.	98.5	WQXR-FM	New York, N. Y.	96.3
WFMR	New Bedford, Mass.	98.1	WJPG-FM	Green Bay, Wisc.	101.1	WRAL-FM	Raleigh, N. C.	101.5
WFMU	Crawfordsville, Ind.	102.9	WJTN-FM	Jamestown, N. Y.	93.3	WRAK-FM	Williamsport, Pa.	100.3
WFMY	Greensboro, N. C.	97.3	WJW-FM	Cleveland, Ohio	104.1	WRBL-FM	Columbus, Ga.	93.3
WFNC	Allentown, Pa.	95.9	WKAP-FM	Allentown, Pa.	100.7	WRC-FM	Washington, D. C.	93.9
WFNG-FM	Fayetteville, N. C.	98.1	WKAT-FM	Miami Beach, Fla.	93.1	WRCM	New Orleans, La.	97.1
WFNS-FM	Burlington, N. C.	99.9	WKBH-FM	La Crosse, Wisc.	93.1	WRGA-FM	Rome, Ga.	106.5
WFOB	Fostoria, Ohio	105.5	WKBN-FM	Youngstown, Ohio	98.9	WRGK	La Grange, Ill.	103.1
WFOR-FM	Lincoln, Nebr.	102.9	WKBR-FM	Manchester, N. H.	100.1	WRLD-FM	West Point, Ga.	102.9
WFRO-FM	Fremont, Ohio	99.3	WKIL	Kankakee, Ill.	100.7	WRLD-FM	Lanett, Ala.	102.9
WFRS	Grand Rapids, Mich.	92.5	WKJG-FM	Fort Wayne, Ind.	106.1	WRNY-FM	Rochester, N. Y.	97.9
WFUV	New York, N. Y.	90.7	WKNB-FM	New Britain, Conn.	103.7	WROL-FM	Knoxville, Tenn.	97.3
WGAL-FM	Lancaster, Pa.	101.3	WKNP-FM	Corning, N. Y.	106.1	WROV-FM	Roanoke, Va.	103.7
WGAN-FM	Portland, Me.	101.9	WKOK-FM	Sunbury, Pa.	94.1	WRRN-FM	Warren, Ohio	107.9
WGAY-FM	Silver Springs, Md.	102.3	WKPB	Knoxville, Tenn.	93.3	WRUN-FM	Rome, N. Y.	105.7
WGBA-FM	Columbus, Ga.	95.1	WKPT-FM	Kingsport, Tenn.	98.5	WRUC	Norfolk, Va.	102.5
WGBG-FM	Greensboro, N. C.	100.3	WKRG-FM	Mobile, Ala.	99.9	WRXW	Louisville, Ky.	95.1
WGBR-FM	Goldsboro, N. C.	93.3	WKRT-FM	Cortland, N. Y.	99.9	WSAL	Saginaw, Mich.	98.1
WGMF	Schenectady, N. Y.	99.5	WKWK-FM	Wheeling, W. Va.	97.3	WSAN-FM	Allentown, Pa.	99.9
WGH-FM	Norfolk, Va.	96.5	WKY-FM	Oklahoma City, Okla.	98.9	WSAP-FM	Portsmouth, Va.	99.7
WGHF-FM	New York, N. Y.	101.9	WKYC	Paducah, Ky.	93.3	WSAR-FM	Fall River, Mass.	103.7
WGNB	Chicago, Ill.	98.7	WLAD-FM	Danbury, Conn.	98.3	WSAV-FM	Savannah, Ga.	100.3
WGNCFM	Gastonia, N. C.	101.9	WLAN-FM	Lancaster, Pa.	96.9	WSBA-FM	York, Pa.	103.3
WGOV-FM	Yaldosta, Ga.	92.5	WLAV-FM	Grand Rapids, Mich.	96.9	WSBF	South Bend, Ind.	101.3
WGPA-FM	Bethlehem, Pa.	95.1	WLAW-FM	Lawrence, Mass.	93.7	WSFA-FM	Montgomery, Ala.	103.3
WGST-FM	Atlanta, Ga.	94.1	WLBR-FM	Lebanon, Pa.	100.1	WSGN-FM	Birmingham, Ala.	93.7
WGTM-FM	Wilson, N. C.	106.7	WLDS-FM	Jacksonville, Ill.	100.5	WSHS	Floral Park, N. Y.	90.3
WGTR	Boston, Mass.	99.1	WLET	Toccoa, Ga.	102.9	WSIC-FM	Statesville, N. C.	105.7
WGUY-FM	Bangor, Me.	93.1	WLEY	Elmwood Park, Ill.	107.1	WSJS-FM	Winston-Salem, N. C.	104.1
WGYN-FM	New York, N. Y.	97.9	WLIN-FM	Merrill, Wis.	101.7	WSLS-FM	Roanoke, Va.	99.1
WHA-FM	Madison, Wis.	91.5	WLOB-FM	Claremont, N. H.	106.1	WSM-FM	Nashville, Tenn.	93.3
WHAD	Delafield, Wis.	90.7	WLOG-FM	Logan, W. Va.	103.3	WSMB-FM	New Orleans, La.	102.7
WHAV-FM	Haverhill, Mass.	92.5	WLOS-FM	Asheville, N. C.	104.3	WSNJ-FM	Bridgeton, N. J.	98.9
WHBC-FM	Canton, Ohio	94.1	WLPM-FM	Suffolk, Va.	97.9	WSON-FM	Henderson, Ky.	99.5
WHBF-FM	Rock Island, Ill.	98.9	WLTN	Lewiston, Pa.	97.9	WSOU	South Orange, N. J.	89.5
WHBS-FM	Huntsville, Ala.	95.1	WLVA-FM	Lynchburg, Pa.	97.5	WSOY-FM	Decatur, Ill.	98.7
WHCU-FM	Ithaca, N. Y.	97.3	WLWA-FM	Cincinnati, Ohio	101.1	WSPA-FM	Spartanburg, S. C.	101.5
WHDH-FM	Boston, Mass.	94.5	WMAR-FM	Baltimore, Md.	97.9	WSPD-FM	Toledo, Ohio	98.9
WHEF-FM	Rochester, N. Y.	96.5	WMAS-FM	Springfield, Mass.	94.7	WSRK	Shelbyville, Ind.	101.3
WHFB-FM	Benton Harbor, Mich.	99.9	WMAZ-FM	Macon, Ga.	99.1	WSRS-FM	Cleveland Heights, Ohio	95.3
WHFM	Rochester, N. Y.	98.9	WMBD-FM	Peoria, Ill.	92.5	WSTC-FM	Stamford, Conn.	96.7
WHIO-FM	Dayton, Ohio	99.1	WMBH-FM	Joplin, Mo.	96.1	WSTP-FM	Salisbury, N. C.	106.5
WHIS-FM	Bluefield, W. Va.	104.5	WMBS-FM	Uniontown, Pa.	105.7	WSTV-FM	Steubenville, Ohio	103.5
WHKX	Cleveland, Ohio	100.7	WMCF-FM	Memphis, Tenn.	99.7	WSVA-FM	Harrisonburg, Va.	100.7
WHKY-FM	Hickory, N. C.	102.9	WMCK-FM	McKeesport, Pa.	104.9	WSYR-FM	Syracuse, N. Y.	94.5
WHLD-FM	Niagara Falls, N. Y.	98.5	WMCP	Baltimore, Md.	94.7	WTAD-FM	Quincy, Ill.	99.5
WHMA-FM	Anniston, Ala.	100.5	WMFR-FM	High Point, N. Y.	99.5	WTAG-FM	Worcester, Mass.	96.1
WHNY-FM	Hempstead, N. Y.	98.3	WMGM-FM	New York, N. Y.	100.3	WTAL-FM	Tallahassee, Fla.	103.9
WHO-FM	Des Moines, Iowa	100.3	WMIN-FM	St. Paul, Minn.	99.5	WTAR-FM	Norfolk, Va.	97.3
WHOP-FM	Hopkinsville, Ky.	98.7	WMIT	Winston-Salem, N. C.	106.9	WTCN-FM	Minneapolis, Minn.	97.1
WHP-FM	Harrisburg, Pa.	97.3	WMIX-FM	Mt. Vernon, Ill.	94.1	WTFM-FM	Tiffin, Ohio	98.3
						WTHT-FM	Hartford, Conn.	106.1
						WTIC-FM	Hartford, Conn.	96.5
						WTJS-FM	Jackson, Tenn.	100.7
						WTMA-FM	Charleston, S. C.	95.1
						WTMJ-FM	Milwaukee, Wis.	93.3
						WTOC-FM	Savannah, Ga.	97.3
						WTPS-FM	New Orleans, La.	95.7
						WTRF-FM	Belkair, Ohio	95.1
						WTRI-FM	Troy, N. Y.	102.7
						WTRT-FM	Toledo, Ohio	99.9
						WTSP-FM	St. Petersburg, Fla.	102.5
						WTTH-FM	Port Huron, Mich.	99.1
						WTTR	Boston, Mass.	104.1
						WVAW-FM	Cheviot, Ohio	96.7
						WVUN	Chattanooga, Tenn.	98.1
						WWCF	Greenfield, Wis.	94.9
						WWDC-FM	Washington, D. C.	101.1
						WWDX-FM	Paterson, N. J.	107.1
						WWHG	Hornell, N. Y.	105.3
						WWJ-FM	Detroit, Mich.	97.1
						WWLH	New Orleans, La.	100.3
						WWNY-FM	Watertown, N. Y.	100.5
						WWPG-FM	Palm Beach, Fla.	97.9
						WWST-FM	Wooster, Ohio	104.5
						WWVA-FM	Wheeling, W. Va.	98.7
						WXHR-FM	Cambridge, Mass.	96.9
						WXLW-FM	Indianapolis, Ind.	94.9
						WXNJ-FM	Plainfield N. J.	103.9
						WXYZ-FM	Detroit Mich	101.1

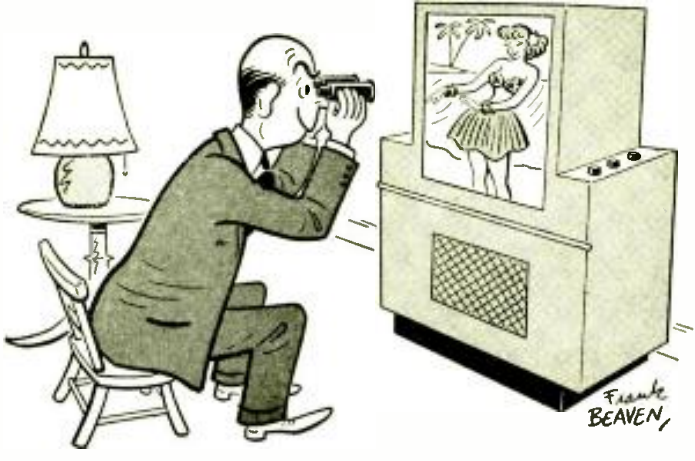

RADIO-CRAFT for

SENSATIONAL VALUE

THE NEW MODEL 770

AN ACCURATE POCKET-SIZE VOLT-OHM-MILLIAMMETER

(Sensitivity 1000 Ohms per volt)

Features:

- ★ Measures A.C. Volts, D.C. Volts, D.C. Current and Resistance.
- ★ Compact—measures 3 1/8" x 5 3/8" x 2 1/4".
- ★ Uses latest design 2% accurate 1 mil. D'Arsonval type meter.
- ★ Housed in round-cornered, molded case.
- ★ Beautiful black etched panel. Depressed letters filled with permanent white, insures long-life even with constant use.



Specifications:

- 6 A.C. VOLTAGE RANGES:
0—15/30/150/300/1500/3000 Volts
- 6 D.C. VOLTAGE RANGES:
0—7 1/2/15/75/150/750/1500 Volts
- 4 D.C. CURRENT RANGES:
0—1 1/2/15/150 Ma. 0—1 1/2 Amps.
- 2 RESISTANCE RANGES:
0—500 ohms 0—1 Megohm

THE MODEL 770 Comes complete with self-contained batteries, test leads and all operating instructions.



THE NEW MODEL 247

← TUBE TESTER

Checks octals, loctals, bantam jr. peanuts, television miniatures, magic eye, hearing aids, thyratrons, the new type H. F. miniatures, etc.

Features:

- ★ A newly designed element selector switch reduces the possibility of obsolescence to an absolute minimum.
- ★ When checking Diode, Triode and Pentode sections of multi-purpose tubes, sections can be tested individually. A special isolating circuit allows each section to be tested as if it were in a separate envelope.
- ★ The Model 247 provides a super sensitive method of checking for shorts and leakages up to 5 Megohms between any and all of the terminals.
- ★ One of the most important improvements, we believe, is the fact that the 4 position fast-action snap switches are all numbered in exact accordance with the standard R. M. A. numbering system. Thus, if the element terminating in pin No. 7 of a tube is under test, button No. 7 is used for that test.

Model 247 comes complete with new speed-read chart. Comes housed in handsome, hand-rubbed oak cabinet sloped for bench use. A slip-on portable hinged cover is indicated for outside use. Size: 10 3/4" x 8 3/4" x 5 3/4".

ONLY

\$29⁹⁰
NET



THE MODEL 650 — AN A.C. OPERATED

SIGNAL GENERATOR →

RANGE: 100 KILOCYCLES TO 105 MEGACYCLES

- ★ RF obtainable separately or modulated by the Audio Frequency.
- ★ Audio Modulating Frequency—100 cycles pure sine wave—less than 2% distortion.
- ★ Attenuation—3-step ladder type of attenuator (T pad).
- ★ Uses a Hartley Excited Oscillator with a Buffer Amplifier.
- ★ Tubes: 6J5 as R.F. Oscillator; 6SA7 as modulated buffer and Mixer; 6SL7 as audio oscillator and rectifier.

Model 650 comes complete with coaxial cable, test leads and instructions. Housed in heavy gauge grey crystalline cabinet with beautiful two tone etched front panel. Size 9 1/2" x 10" x 6".....NET PRICE:

\$39⁹⁵



OUR POLICY • ALL MODELS DESCRIBED ABOVE ARE OFFERED ON MONEY-BACK-IF-NOT-SATISFIED BASIS. • ALL ITEMS AVAILABLE FOR IMMEDIATE SHIPMENT FROM STOCK. • ALL MERCHANDISE GUARANTEED TO BE EXACTLY AS DESCRIBED—ALL BRAND NEW—NO SURPLUS.
20% Deposit Required on all C.O.D. Orders

MOSS ELECTRONIC DISTRIBUTING CO. DEPT. RC-6 229 FULTON STREET
NEW YORK 7, N. Y.

JUNE, 1948

Glossary of FM Terms

Compiled by JOHN B. LEDBETTER

amplitude distortion. Result of nonlinear action in the grid-cathode or plate-cathode circuit of an amplifier, causing frequencies to appear in the output which were not present at the input.

amplitude modulation (AM). A system of broadcasting in which the amplitude or strength of the radio wave is varied with modulation.

antenna gain. A measure of antenna strength; determined by comparing the power ratio between the antenna under test and a standard antenna having a gain of one. Ratio is determined by the Poynting vector or by measuring radiation resistance.

antenna height (above average terrain). Actual physical height above average or mean height of terrain to top of antenna.

antenna height, effective. Ratio of the total signal voltage at the receiving antenna to the strength of the radiated wave. (In a quarter-wave vertical wire antenna, effective height = $2/\pi$ x actual height.)

antinodes. See Nodes.

atmospherics. Static or electrical disturbances caused by storms.

audio compressor-expander. A limiting type of audio amplifier designed to compress audio peaks to a predetermined level, and to increase low-level passages to a desired value.

audio peak chopper. An amplifier designed to keep peak amplitudes from exceeding a desired value by instantaneous clipping of those peaks.

audio peak limiter. An amplifier in which the gain is quickly reduced and then slowly restored when instantaneous peaks exceed a predetermined level.

audio response. The degree of fidelity inherent in any part of equipment transmitting or receiving audio signals.

automatic frequency control (a.f.c.). A system for correcting the master oscillator frequency in FM transmitters. Modulation is applied in series with the control grid of a reactance tube, whose transconductance (and reactance across the oscillator tank) is varied accordingly. A degenerative feedback circuit is used to heterodyne the oscillator frequency to an intermediate frequency to minimize frequency drift. (In some receivers, a.f.c. is used to compensate automatically for incorrect dial settings.)

blanket effect. Tendency of an FM signal to suppress completely a weaker signal on the same channel. This effect is largely due to action in the receiver limiter circuit.

carrier shift (carrier deviation). The amount (in cycles) by which the center frequency departs from its assigned value. Deviation limit set by FCC is 2,000 cycles.

carrier wave. The unmodulated component of the wave emitted from the transmitter.

center frequency. The exact assigned frequency of an FM transmitter when no modulation is applied. Also known as resting frequency, idle frequency, carrier frequency, or mean frequency.

channel. A station's assigned frequency. Width of AM channels is 10 kc, FM channels 200 kc (FM frequencies 88-108 mc correspond to channels 201-300).

characteristic impedance (or resistance). When referring to a transmission line, the value of resistance which will match that of the line and completely absorb the transmitted energy. Other values will result in loss of power through reflected energy and standing waves.

class A station. One intended to serve a community or town, other than the principal city in the area, and surrounding rural area. Minimum power, 100 watts, maximum, 1 kw, with antenna 250 feet above average terrain. Twenty class A channels are provided.

class B station. One serving the metropolitan district or principal city and surrounding area, or a rural area removed from large cities. Minimum power east of Mississippi, 10 kw with an antenna height of 300 feet; maximum power, 20 kw with 500-foot antenna. West of Mississippi power in excess of this maximum is granted if need is shown. Sixty class B channels are provided.

co-axial line. Transmission line for coupling transmitter to antenna; composed of one copper conductor placed within another of larger diameter and insulated from it by ceramic spacers. Outer conductor is at ground potential; inner conductor carries the energy. Line is made airtight and filled with low-pressure gas to minimize moisture content.

common channel interference. A possible form of interference appearing as cross-talk or as a beat

note. To avoid this type of interference, strength of the desired station need be only ten times that of the undesired signal.

conditional grant (CG). Authorization for a new FM station provided certain terms or conditions are fulfilled.

construction permit (CP). Authorization to proceed with construction of a new station; issued after previous terms have been met.

cross-modulation. The impression of one station's modulation on the carrier of another. Modulation from both stations may appear simultaneously.

de-emphasis network. An arrangement at the receiver, usually consisting of a 100,000-ohm resistor and a .001- μ f condenser, for reducing pre-emphasized frequencies to their original values.

demodulation. Action by which a frequency-modulated signal is converted into audio voltage.

deviation ratio. The frequency swing (75 kc) divided by the highest audio frequency.

dipole. A directional receiving antenna, composed of two $1/4$ -wave length elements placed end-to-end and insulated at the center.

direct frequency modulation. A way of producing frequency-modulated signals in which the master oscillator stage is modulated directly, usually by a reactance tube (or tubes) connected across its tank circuit and the reactance varied at an audio rate. The small frequency swing thus obtained is increased by frequency multipliers to the correct value.

direct wave. The component part of a space wave which travels in a straight line from transmitting antenna to receiving antenna.

discriminator. A demodulator circuit (corresponding to the second detector in AM receivers). Assists the limiter circuit in removing or suppressing amplitude variations in the frequency-modulated signal. Discriminator circuits are employed in some types of direct-FM transmitters to stabilize the carrier frequency.

doublet. A receiving antenna whose physical length is short compared to wave length. Large end capacitance causes an even distribution of current throughout the conductor. Similar otherwise to the dipole.

dynamic noise suppressor. An amplifier equipped with electronic gate circuits which effectively eliminate noise and record-scratch frequencies without apparent effect on music.

dynamic range. Difference in level between loudest and softest sounds contained in a broadcast, i.e., symphony and concert offerings.

effective radiated power (ERP). The product of transmitter output times antenna gain. A transmitter running 5 kw into an antenna whose gain is 6 has an effective radiated power of 30 kw.

elevation. The height of an antenna site above sea level.

equalization, line. Treatment of a telephone or network line, in which the frequency response is extended to suit broadcast purposes.

equalizer. A network designed to change the audio-frequency response of a circuit. Equalizers may be inserted to give a certain cut-off point to improve noise rejection, or to extend the normal response characteristics of a line.

field strength. The strength of a radio wave, expressed as voltage stress produced in space by the wave's electric field; usually expressed in microvolts or millivolts (per meter).

folded doublet. A doublet type of receiving antenna whose elements have been doubled back on themselves to form an effective loop.

frequency deviation. Frequency swing, or amount of departure from the resting frequency with modulation.

frequency deviation range. 150 kc maximum (75 kc each side of center frequency). The 25-kc portion at each extreme edge of the range is used only as a guard frequency.

frequency dividers. Stages of radio-frequency amplifiers, used to divide and compare the frequencies of the modulated oscillator and a crystal standard. The difference voltage is applied to a motor control system to correct for drift.

frequency modulation (FM). A system of radio broadcasting in which modulation is accomplished by varying the carrier frequency width, while the carrier amplitude remains constant. Band width of FM channels is 200 kc; maximum frequency swing is 75 kc each side of center.

frequency monitor. An electronic instrument employed at the transmitter to indicate departure.

(Continued on page 49)

A MODERN HIGH-POWER FM TRANSMITTER

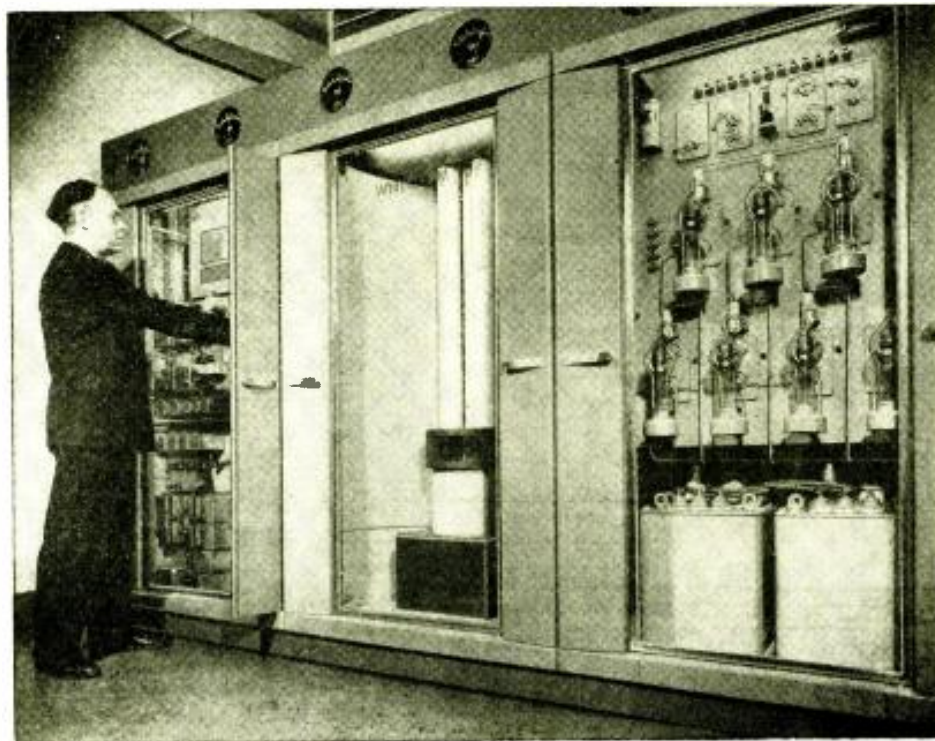

William H. Pitkin, the chief engineer of New York City's Municipal Broadcasting System, makes an adjustment on Station WNYC-FM's new Western Electric 10-kilowatt transmitter.

RADIO-CRAFT for

A GREAT **TRANSVISION** FIRST!

**NEW. . . Sensational TRANSVISION Development now offers
LARGE-IMAGE DIRECT-VIEW TELEVISION at low cost!**

BIGGEST VALUE in TELEVISION!
Model 10BL TELEVISION KIT with FM Radio
. . . Features Beautiful CABINET with BUILT-IN
LENS . . . Gives LARGE 120 Sq. In. Picture.

Roto-picture effect: Picture "rotates", giving the appearance of being in focus and clearly visible from every angle! Uses 10" Electromagnetic Direct-view Picture Tube.

Features new-type cabinet with built-in lens which magnifies, clarifies and heightens contrast of the picture. The lens also creates the effect of apparent rotation of the picture, so that when the observer moves, the picture still seems to be in focus and clearly visible from any angle.

ECONOMICAL KIT, EASY TO ASSEMBLE. In point of value, this Television Kit provides the opportunity of acquiring a LARGE-IMAGE direct-view television set at a VERY LOW PRICE; also very economical from a tube replacement angle. This model is available in KIT FORM, for easy assembly; no technical knowledge required. Simple step-by-step instructions are included. Saves as much as 50% over the cost of receivers with similar picture magnitude.

TECHNICAL DATA: Model 10BL uses a 10" Electro-magnetic Direct-view Picture Tube; has complete F.M. Radio which comes completely factory-wired; receives all channels in any area; supplied complete with antenna and lead-in wire. The LENS is 15" x 11", giving a picture size of approx. 10" x 12" or 120 sq. in.; the highly-styled cabinet measures 26" wide x 17" high x 19" deep, available in Mahogany, Walnut or Blonde finishes.

PRICES: Transvision MODEL 10BL Television Kit, with FM, 10" tube, cabinet with built-in lens, antenna, 60 ft. lead-in wire **List \$359.00**
MODEL 12BL, same as 10BL except that it uses 12" tube, giving picture area of 130 sq. in. **List \$389.00**



MODEL 10BL



MODEL 7BL

SCOOP! New revolutionary MODEL 7BL Television Kit with specially designed CABINET with BUILT-IN LENS.

- Uses 7" Electrostatic Picture Tube
- Gives 50 square inch picture of superior quality

FEATURES: Though it has a 7" tube, the effect is equivalent to a 10" set because the built-in lens magnifies the picture. Also picture performance is superior because the lens clarifies and heightens contrast of the image. Picture "rotates" apparently, as the observer moves, giving the effect of always facing the observer. This is effective to a very wide angle. Pre-tuned for 5 channels.

PRICE: including cabinet with built-in lens, antenna, 60 ft. of lead-in wire **Net \$189.00**

TRANSVISION "SERVICE NOTES"

The Key to Successful Television Servicing

Transvision's "Service Notes" is a compilation of confidential Television Notes and Information, the product of experience with over 20,000 television receivers, now made available to the public. The "Service Notes" is a most valuable compilation of instructions and data on Magnetic and Electrostatic Television Receivers. Though compiled in the course of servicing Transvision Kits, the information is applicable to any type of television receiver. "SERVICE NOTES" is complete with photographs and diagrams. The information is worth a small fortune. The cost is low. LIST \$2.95



All prices 5% higher west of Mississippi; all prices fair traded.

For further information see your distributor, or write to:

TRANSVISION INC., Dept. RC, NEW ROCHELLE, N. Y.

War Surplus Bargains

NAVY CRV-46151 AIRCRAFT RADIO RECEIVER

INCLUDING
CASE

\$19⁵⁰



Four bands, including broadcast (195-9,050 KC). Circuit is six-tube super-heterodyne with mechanical band change. Powered from self-contained 24 V. DC dynamotor. The sets are complete with tubes, mounting rack and remote controls. No cables or plugs.

ARC-4 TRANSMITTER & REC.

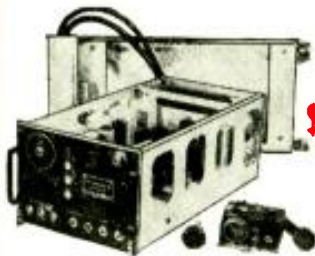

INCLUDING
CASE

\$19⁹⁵

Operates on any of its 4 predetermined crystal controlled frequencies in the range of 140 MC. Complete with tubes, remote control, junction box, shock mounting base and connecting plugs. This unit is ideal for amateur UHF or mobile telephone. Operates from self-contained 24 V. DC dynamotor.

TELRAD 18-A FREQUENCY STANDARD

Checks signals in the range of 100 Kc. to 45 Mc. with a high degree of accuracy. Self-contained power supply is 110, 130, 150, 220, and 250 V. 25-60 cycle AC. Complete with tubes, dual crystal, and instruction book. Brand new. Price **\$24.95**

**T-17-B Carbon Microphones
Handmike** **95c**

**HEADPHONE EXTENSION
CORD** **50c**

WILLARD LEAD ACID CELLS

6 V. (dry chgd.) **\$3.00**
6 V. (in metal carrying case, dry chgd.) **\$4.00**
(Odd electrolyte, specific gravity 1.265-drug-store).

**Art/13 Control Head With
Connecting Plug** **\$2.50**

**DYNAMOTOR MODULATOR
UNIT** **\$1.95**

Antenna Relay Unit ... **\$1.25**

INTERPHONE AMPLIFIER
\$1.95

All Prices F. O. B. Indianapolis

TERMS: CASH WITH ORDER

AMERICAN SURPLUS PRODUCTS CO.

537 N. CAPITOL AVE.
INDIANAPOLIS, IND.

... I.F. TRANSFORMER REPAIRS

I.f. transformers in some older receivers have special trimmer assemblies and are therefore difficult to replace. If a coil in one of these transformers becomes defective, and it is impossible to obtain a replacement transformer, here is an easy way to repair the unit.

Measure the space between the two windings, and cut through the core piece just below the top coil. Then remove the bottom coil of a standard i.f. transformer of the same frequency, also by cutting through the core.

Roll a piece of thin cardboard and use it as a dowel to fit the two coils together. Make sure the spacing between the coils is the same as before. A little cement on the joint completes the repair.

ALBERT LOISCH,
Darby, Pa.

... TUBE REPLACEMENT

If a 2W3 half-wave rectifier is not available to replace a defective one, an OZ4 can be used in its place. Merely connect the two OZ4 plate pins together at the socket and plug in the tube.

PETER CASELLA,
New Orleans, La.

... CHEVROLET MODEL 985538

A replacement was unobtainable for the defective antenna coil in this set, and substitute antenna coils did not give good results. I finally used a 4-pie, 2.5-mh r.f. choke with a lead to the 6SA7 grid tapped off between the first and second pies from one end. The lead from the upper three pies went to the antenna and the other lead to the a.v.c.

The set then played perfectly with a 66-inch auto antenna.

PAUL STANLEY,
Chatsworth, Ga.

... RECORD CHANGERS

A frequent complaint on several makes of automatic record changers is that the turntable slows down after playing two or three records. This trouble can be eliminated on most friction-drive-type changers by applying a General Cement Resin Stick to the inside rim of the turntable.

LYMAN E. GRAY,
Alexandria, La.

... AUTOMATIC MODEL 640

In these models a loud hum which is not caused by defective filter condensers and which cannot be controlled by the volume control, is often the fault of an excessively long volume control ground lead. If the size of the filter resistor is changed to 2,000 ohms at 2 watts, hum will also decrease appreciably with practically no change in performance.

ARTHUR L. JOHNSON,
Hutchinson, Kansas

... RCA MODEL IX2

If the set is very weak or is suddenly reduced in volume, but the tubes test good, check the a.v.c. filter condenser. Replacing this condenser with a new one usually clears up the trouble.

WILLIAM PORTER,
Lafayette, Indiana

... PHILCO MODEL 18

The oscillator in this set sometimes operated intermittently. A complete check of the oscillator revealed a high-resistance short across the oscillator coil. Coil replacement was the cure.

WILLIAM PORTER,
Lafayette, Indiana

... OVERHEATED RESISTORS

When a shorted bypass condenser is replaced, also change the dropping resistor through which the current was drawn. The resistor has usually been overheated sufficiently to cause it to change its value considerably.

HENRY VAN ZUYEN,
Hanford, Calif.

... CROSLEY MODEL 86CR

The molded wire-wound filter resistor between the two filter condensers is frequently found to be open. Substitution of a good-quality, 10-watt unit cures the trouble permanently.

WILLIAM PORTER,
Lafayette, Indiana

... MAJESTIC MODEL 460

If the receiver oscillates and squeals but all the voltages are correct, check the main filter condensers. In some cases these condensers may lose enough capacitance to cause oscillation long before any hum can be noticed.

WILLIAM B. THORNE,
St. John, N.B., Canada

... CROSLEY MODEL 146CS

Noise heard when the r.f. tube is tapped and which is not due to a bad tube is usually caused by a defective .001- μ f screen bypass condenser. Replace the condenser with a ceramic-type condenser, and check the stage for any possible misalignment which may have occurred during servicing.

ARTHUR L. JOHNSON,
Hutchinson, Kansas

... STEWART-WARNER MODEL 51T146

A frequent complaint on these sets is an intermittent drop in over-all sensitivity, resulting in only local stations being heard. The trouble is due to increased resistance of the soldered terminals of the secondary of the first i.f. transformer inside the shield can. Resolder the connections or replace the transformer.

ARTHUR L. JOHNSON,
Hutchinson, Kansas

... PHILCO 38—116 CODE 125

A common complaint on this model is a broken dial support. The dial is mounted on its axis by a single strip of celluloid which often breaks. The dial will then not turn with the tuning condenser. Repair by cementing 4 pieces of clear celluloid around the rear of the dial with transparent cement. If carefully done, the repair cannot be seen from the front of the cabinet.

D. L. FUQUA
Fairfield, Iowa

New 1948 and F.M. Manuals



F.M. and Television

Use this new giant manual of factory instructions for troubleshooting, repairing, and alignment of any 1947-1948 F.M. and Television set. Every popular make, including new F.M. tuners, AM-FM combinations, and all types of television receivers. Detail circuit diagrams, theory of operation, test hints, alignment data, including both meter and oscilloscope methods. This is the material you need to fix any modern F.M. or Television set. Don't turn this profitable work away for lack of knowledge and information. Use this newest Supreme manual to save time and money on your very next F.M. job. Data presented on 192 large pages, 8½x11 in. Sturdy, manual-style binding. Just published. Special price. **\$2.00**

New 1948 Manual

Be prepared to repair quickly all new 1948 receivers. In this big single volume you have clearly-printed, large schematics, needed alignment data, replacement parts lists, voltage values, and information on stage gain, location of trimmers, and dial stringing, for almost all recently released sets. Makes toughest jobs amazingly easy. Find faults in a jiffy. Speed-up all repairs. The time saved on your next job will pay the \$2 bargain price for the complete manual—after that you use it FREE. A worthy companion to the 7 previous volumes used by over 120,000 shrewd radio servicemen. New manual covers models of 42 different manufacturers. Giant size: 8½x11", 192 pages + index. Manual-style binding. Price, only. **\$2.00**

BIGGEST BARGAIN IN RADIO DIAGRAMS

Make these two new mammoth volumes your money-saving source for data on all recently released receivers. Learn about modern circuit developments, be ready to repair any new radio no matter how complex. You pay only \$2 for each of these large manuals. With these two volumes on your workbench there is nothing else to buy, nothing else to pay—a whole year of radio diagrams and service data yours for a couple of dollars total. Again Supreme Publications beats all competition and gives radio servicemen greatest bargains in service information. Other volumes for previous years described below. **No-risk** examination granted to servicemen.

FIND ALL RADIO FAULTS DOUBLE-QUICK

You can speed-up and simplify radio repairs with SUPREME PUBLICATIONS Manuals. Service all radios faster, better, easier, save time and money, use these most-often-needed diagram manuals to get ahead, earn more per hour. For the remarkable bargain price (only \$2 for most volumes) you are assured of having in your shop and on the job, needed diagrams and other essential repair data on 4 out of 5 sets you will ever service. Every popular radio of all makes from old-timers to new 1948 sets, including F.M. and Television, is covered. Clearly printed circuits, parts lists, alignment data, and helpful service hints are the facts you need to improve

your servicing ability. Save hours each day, every day, begin to earn more by making repairs in minutes instead of hours. Let these manuals furnish you with diagrams for 80% of all sets. There is no need to spend large sums for bulky, space-wasting manuals, or to buy additional drawings every few weeks; be wise, use SUPREME Manuals to get the most in diagrams and service data for the smallest cost. Act today and be money ahead with Supreme Publications.

Models Made by:

- R.C.A., Zenith,
- Philco, Sears, Fada,
- Emerson, Belmont,
- Detrola, Crosley,
- G.E., Westinghouse,
- Arvin, Majestic,
- Stewart-Warner,
- Admiral, Delco,
- Stromberg-Carlson,
- Wards, West'n Auto,
- Sparton, Motorola,
- and many others.

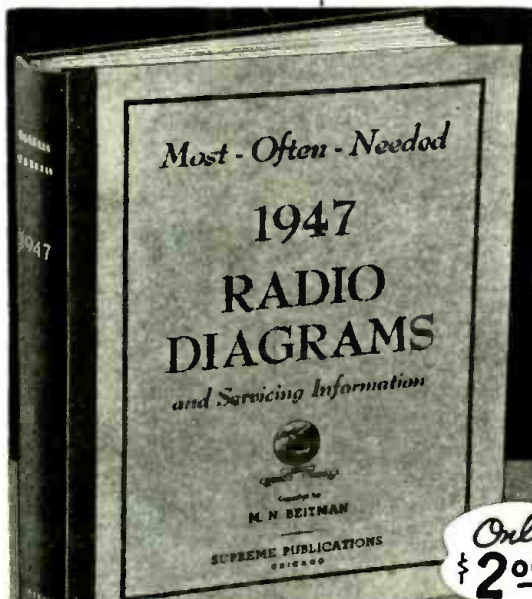

Use coupon to order manuals for examination
Include all popular sets from 1926 to 1948.

Record Changers Manuals

Post-War Models

Service expertly all modern (1945-1948) record changers. Just follow simplified factory instructions to make needed adjustments and repairs. Hundreds of photographs and exploded views. Large size: 8½ x 11 inches. 144 fact-filled pages. Price only \$1.50, postpaid.

Pre-War Models

Just what you need to repair quickly thousands of pre-war (before 1942) automatic record changers, manual units, pick-ups, wireless oscillators, recorders, and combinations. Hundreds of mechanical and electrical diagrams. 128 large pages; size 8½ x 11 inches. Price, only \$1.50.

See Your Radio Jobber or Send Coupon →

Supreme Publications

PUBLISHERS OF RADIO BOOKS, MANUALS, AND DIAGRAMS

9 South Kedzie Ave.

Chicago 12, Illinois

JUNE 1948

NO RISK TRIAL ORDER COUPON

SUPREME PUBLICATIONS, 9 S. Kedzie Ave., Chicago 12, ILL.

Ship the following manuals on trial under your guarantee of satisfaction or money-back.

- | | | | |
|--|--------|--------------------------------------|---|
| <input type="checkbox"/> New F.M. and Television Manual.. | \$2.00 | <input type="checkbox"/> 1948 | PRICED
AT ONLY
\$2
EACH |
| <input type="checkbox"/> Post-War Record Changers..... | 1.50 | <input type="checkbox"/> 1947 | |
| <input type="checkbox"/> Pre-War Record Players & Recorders | 1.50 | <input type="checkbox"/> 1946 | |
| <input type="checkbox"/> I am enclosing \$....., send postpaid. | | <input type="checkbox"/> 1942 | |
| <input type="checkbox"/> Send C.O.D. I am enclosing \$..... deposit. | | <input type="checkbox"/> 1941 | |
| | | <input type="checkbox"/> 1940 | |
| | | <input type="checkbox"/> 1939 | |
| | | <input type="checkbox"/> 1926-1938 — | \$2.50 |

Name:
Address:

HEATHKIT SERVICE INSTRUMENTS

BUILD . . . LEARN . . . SAVE

Ideal for Schools, Training Courses, Laboratories—Service Shops, Hobbyists.

HEATHKIT SIGNAL GENERATOR KIT



\$19.50

NOTHING ELSE TO BUY

Every shop needs a good signal generator. The Heathkit fulfils every servicing need, fundamentals from 150 Kc. to 30 megacycles with strong harmonics over 100 megacycles covering the new television and FM bands. 110 V 60 cycle transformer operated power supply.

400 cycle audio available for 30% modulation or audio testing. Uses 6SN7 as RF oscillator and audio amplifier. Complete kit has every part necessary and detailed blueprints and instructions enable the builder to assemble it in a few hours. Large easy to read calibration. Convenient size 9" x 6" x 4 3/4". Weight 4 1/2 pounds.

HEATHKIT SINE AND SQUARE WAVE AUDIO GENERATOR KIT

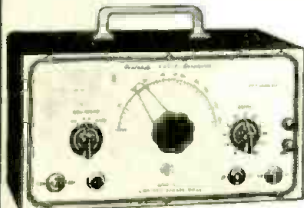

\$34.50

NOTHING ELSE TO BUY

The ideal instrument for checking audio amplifiers, television response, distortion, etc. Supplies excellent sine wave 20 cycles to 20,000 cycles and in addition supplies square wave over same range. Extremely low distortion, less than 1%, large calibrated dial, beautiful 2 color panel, 1% precision calibrating resistors, 110 V 60 cycle power transformer, 5 tubes, detailed blueprints and instructions. R.C. type circuit with excellent stability. Shipping weight 15 pounds.

HEATHKIT SIGNAL TRACER KIT



\$19.50

NOTHING ELSE TO BUY

Reduces service time and greatly increases profits of any service shop. Uses crystal diode to follow signal from antenna to speaker. Locates faults immediately. Internal amplifier available for speaker testing and internal speaker available for amplifier testing. Connection for VTVM on panel allows visual tracing and gain measurements. Also tests phonograph pickups, microphones, PA systems, etc. Frequency range to 200 Mc. Complete ready to assemble. 110 V 60 cycle transformer operated. Supplied with 3 tubes, diode probe, 2 color panel, all other parts. Easy to assemble, detailed blueprints and instructions.

Small portable 9" x 6" x 4 3/4". Wt. 6 pounds. Ideal for taking on service calls. Complete your service shop with this instrument.

HEATHKIT HIGH FIDELITY AMPLIFIER KIT

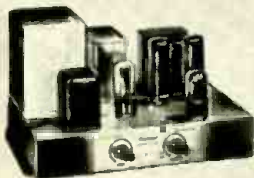

\$14.95

NOTHING ELSE TO BUY

Build this high fidelity amplifier and save two-thirds of the cost. Push pull output using 1619 tubes (military type 6L6's), two amplifier stages using a dual triode (6SN7), and a phase inverter give this amplifier a linear reproduction equal to amplifiers selling for ten times this price. Every part supplied; punched and formed chassis, transformers (including quality output to 3-8-15 ohm voice coil), tubes, controls, and complete instructions. Add postage for 20 lbs. 12" PM speakers for above. \$6.95

NEW 1948 HEATHKIT 5 INCH OSCILLOSCOPE KIT



\$39.50

NOTHING ELSE TO BUY

A necessity for the newer servicing technique in FM and television at a price you can afford. The Heathkit is complete, beautiful two color panel, all metal parts punched, formed, and plated and every part supplied. A pleasant evening's work and you have the most interesting piece of laboratory equipment available.

Check the features—large 5" 5B1 tube, compensated vertical and horizontal amplifiers using 6SJ7's, 15 volts to 30 M cycle sweep generator using 884 gas triode, 110 V 60 cycle power transformer gives 1100 volts negative and 350 volts positive.

Convenient size 8 1/2" x 13" high 17" deep, weight only 26 pounds.

All controls on front panel with test voltage and ext. syn post. Complete with all tubes and detailed instructions. Shipping weight 35 lbs.

Order today while surplus tubes make the price possible.

The NEW HEATHKIT VACUUM TUBE VOLTMETER KIT



\$24.50

NOTHING ELSE TO BUY

The most essential tool a radio man can have, now within the reach of his pocketbook. The Heathkit VTVM is equal in quality to instruments selling for \$75.00 or more. Features 500 microamp meter, transformer power supply, 1% glass enclosed divider resistors, ceramic selector switches, 11 megohms input resistance, linear AC and DC scale, electronic AC reading RMS. Circuit uses 6SN7 in balanced bridge circuit, a 6H6 as AC rectifier and 6X5 as transformer power supply rectifier. Included is means of calibrating without standards. Average assembly time less than four pleasant hours, and you have the most useful test instrument you will ever own. Ranges 0-3, 30, 100, 300, 1000 volts AC or DC. Ohmmeter has ranges of scale times 1, 100, 1000, 10M and 1 megohm, giving range .1 ohm to 1000 megohms. Complete with detailed instructions. Add postage for 8 lbs.

HEATHKIT CONDENSER CHECKER KIT



\$19.50

NOTHING ELSE TO BUY

A condenser checker anyone can afford to own. Measures capacity and leakage from .00001 to 100 MFD on calibrated scales with test voltage up to 500 volts. No need for tables or multipliers. Reads resistance 500 ohms to 2 megohms. 110V 60 cycle transformer operated complete with rectifier and magic eye indicator tubes.

Easy quick assembly with clear detailed blueprints and instructions. Small convenient size 9" x 6" x 4 3/4". Weight 4 pounds. This is one of the handiest instruments in any service shop.

A WORD ABOUT HEATHKIT INSTRUMENTS

All Heathkit service instruments are supplied complete in every way—grey crockle cabinets, 2 color calibrated panels, all tubes, test leads (where required) etc. All are 110 V transformer operated. Calibrations are complete and exact, 1% precision resistors are supplied where needed.

Heath engineers are ready to assist and advise. Heathkits are sold direct to customer, order from this ad. All are guaranteed.



The HEATH COMPANY

DEPT. C. • BENTON HARBOR, MICHIGAN

RADIO-CRAFT for

GLOSSARY OF FM TERMS
(Continued from page 44)

in cycles, from the assigned center frequency.

frequency multipliers. Stages of radio-frequency amplifiers operated as doublers, triplers, etc., to provide the required order of multiplication. In FM transmitters the frequency is multiplied many times before it reaches the final stage.

frequency shift. The departure of a wave from its assigned frequency.

full license. Final authority to operate a commercial FM station. Issued after station has operated satisfactorily on CP (construction permit) and has met all requirements as to field-strength measurements, proof-of-performance tests, program commitments, etc.

ghosts. Secondary wave reflections which reach the receiving antenna out of phase with the initial wave. Ghosts are the result of reflections from the ionosphere, or from hills, apartment buildings, or other structures, and are more prevalent in low spots or areas of low signal strength. In FM, the result may be garbled, distorted reception.

ground wave. The part of a radio wave which depends entirely on conductivity of the earth's surface, and reflection from it, for propagation. The ground wave is composed of a surface wave and a space wave. The space wave is subdivided into a direct wave and a ground-reflected wave.

ground-reflected wave. The component part of a space wave which is radiated from the transmitting antenna and reflected from the earth's surface to the receiving antenna.

grounded-grid amplifier. A radio-frequency amplifier (final stage) in which the grid circuit is at ground potential, the input and output resonant circuits being provided by filament and plate, respectively.

guard band. The 25-kc band width at the extreme ends of each FM channel, used solely to prevent interference to adjacent channels.

harmonics. Even or odd multiples of the fundamental wave frequency.

high fidelity. The faithful and exact transmission or reproduction of audio-frequency signals.

image response. Tendency of a receiver to pick up spurious frequencies equal to twice the i.f. frequency plus or minus the radio frequency. Images are eliminated by adding an r.f. stage or otherwise increasing selectivity.

indirect frequency modulation. See Phase Modulation.

interference, adjacent channel. Cross-modulation effects produced when two signals of near-equal strength are assigned to channels adjacent to each other. Effects are much more pronounced in AM than in FM systems.

interim operation. The period during which station operation is maintained on low power, pending installation of the regular transmitter or antenna system.

ionosphere. (formerly known as the Kennelly-Heaviside layer). Ionized layers of gases existing in the upper parts of the earth's atmosphere, usually at heights between 30 and 250 miles. Radio waves striking these layers are reflected, the amount of reflection depending on layer height, wave frequency, degree of ionization, and other factors.

ionosphere storms. Disturbances in the ionosphere which seriously affect radio transmission above 500 kc. These disturbances are closely linked to the 11-year sun-spot cycle; their appearance can result in unpredictable behavior, even at FM frequencies.

Kennelly-Heaviside layer. See Ionosphere.

limiter. Last i.f. stage or stages of a receiver; arranged to overload so that plate current is saturated and cut off on alternate half-cycles. This action removes amplitude variations and leaves only the frequency-modulated component of the signal. In phase-modulated FM transmitters, a limiter is employed to remove residual amplitude fluctuations.

linearity. The ability of a system (r.f. or a.f.) to maintain an output voltage or percentage in direct proportion to the input voltage.

line-of-sight. The approximate distance to the horizon, or about 30 to 50 miles; formerly supposed to be the limiting factor for FM transmissions. Actual range approaches two or more horizons, due to reflection and refraction characteristics of the earth's surface.

marker frequencies. Frequencies produced by a signal generator to identify frequency deviation limits and to measure discriminator response in receivers. Used in conjunction with an oscilloscope to obtain visual patterns.

modulation. Act of applying audio frequencies to a radio-frequency wave.

modulation index. The frequency swing (frequency deviation) divided by the audio frequency. The index varies directly with the audio-frequency

Now... at a sensationally
LOW PRICE!
ECA QUALITY
FM & TELEVISION

Sweep Signal
GENERATOR
\$34⁹⁵ COMPLETE



**A MUST
FOR FM
& TELEVISION
SERVICE
SHOPS!**

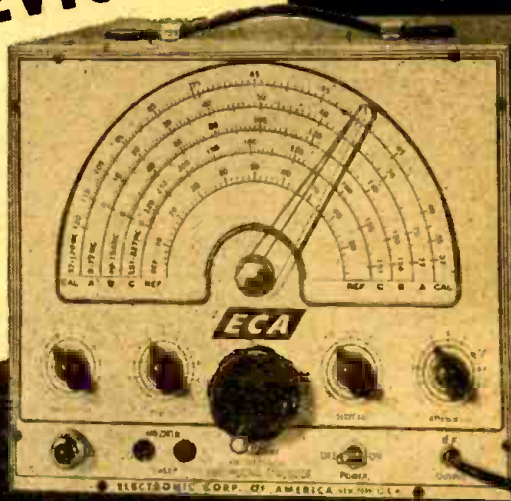

Here's great news for FM and TV Service Shops! A new, top quality sweep signal generator—product of a manufacturer with vast resources, advanced engineering "know-how", and war-time experience in producing test equipment. **DIRECT FROM THE FACTORY**—at a phenomenally low price!

FRONT PANEL CONTROLS

- Sweep width 500 KC to approx. 10 MC
- Phasing control
- Tuning vernier control 10 to 1 ratio
- Selecto switch FM—RF—CAL
- RF Output control
- 60 cycle horizontal sweep output
- Amphenol RF output shielded connector

**FREQUENCY RANGE
3 BANDS**

- (No band switching necessary)
- (2 to 227 Megacycles)
- 2—77 MC
- 40—154 MC
- 151—227 MC
- Calibration and reference scales
- Dial scale length

TUBE LINEUP

- 6C4—Fixed frequency modulated oscillator
- 6C4—Continuously variable beat frequency oscillator
- 6C4—Mixer—Cathode follower output tube
- 5Y3—Rectifier tube

GENERAL INFORMATION

- High frequency insulation throughout
- Maximum output 500,000 U/V
- Power required 105-125 Volt 50-60 AC 35 Watts
- Power line filter built in
- Special Midline capacity tuning condenser
- Pilot light line indicator
- Generator output can be used either frequency modulated or pure RF



RADIATION LOOP AND ALIGNMENT WAND

Provides loose coupling. Checks loop-oscillator tracking. Increases efficiency of receiver's alignment or mistacking. Enables the service engineer to make gain measurements. Professional appearance and accuracy.

results. May be used on any signal generator. Complete with operating instructions. **\$5⁹⁵**

FM FRONTEND

Complete with 3 tubes, including Magic Eye. 88-108 MC.

For use with 10.7 MC I.F.S., high Q resonant tuned lines. Heavy silver overlay on lines and contacts. High frequency insulation throughout I-RF stage, detector, and oscillator. Large 7" sliderule dial. Chassis floated, non-microphonic.



\$15⁹⁵



AM SIGNAL GENERATOR

8 RF bands. Frequency coverage 100KC-75 MC. External modulation from 40 to 30,000 cycles. Internal Modulation at 440 cycles. Phase shift audio oscillator and internal modulator. A.C. 105 to 120 volts. 50 to 60 cycles. Special Hammarlund variable condenser; 3 step RF attenuator. Continuously variable RF-AM attenuator control. Ultra stable two terminal RF oscillator. Pilot light line indicator. Cathode follower output tube. Modulator percentage continuously variable from front panel. Internal or external. 0 to 100%. Heavy 16-gauge steel cabinet. Complete with 4 (standard brand) tubes. Amphenol co-axial connecting cable, ground cable, operating instructions and guarantee. **\$32⁵⁰**

BACKED BY ECA WITH R.M.A. GUARANTEE. FOR PROMPT DELIVERY, RUSH YOUR ORDER TODAY TO DEPT. RC-6. 20% DEPOSIT WITH ORDER REQUIRED. F.O.B. NEW YORK CITY.

ELECTRONIC CORPORATION OF AMERICA
353 WEST 48th STREET • NEW YORK 19 N. Y. • PHONE: CIRCLE 6-1985

WRITE FOR ECA CIRCULAR ON PARTS AND ADDITIONAL EQUIPMENT.



NOW! BUILD 15 RADIOS \$14.75

COMPLETE KIT ONLY...

**ABSOLUTELY NO KNOWLEDGE OF RADIO NECESSARY
YOU NEED NO ADDITIONAL PARTS!**

THE PROGRESSIVE RADIO KIT IS THE ONLY COMPLETE KIT
Operates on 110-120 volts AC/DC. Contains everything you need. Instruction Book, Metal Chassis, Tubes, Condensers, Resistors and all other necessary radio parts. The 36-page Instruction Book written by expert radio instructors and engineers teaches you to build radios in a professional manner. The first circuit built is a simple one-tube detector receiver. Each succeeding circuit incorporates new arrangements of detectors, RF and AF amplifiers. This kit is excellent for learning the principles of receiver, transmitter and amplifier design. It is used in many radio schools and colleges. All of the commonly-used detectors are used including diode, grid leak, plate and infinite-impedance. The transmitters are designed with Hartley and Armstrong oscillators, using screen-grid and control-grid modulation. Both vacuum tube and selenium rectification are employed in these circuits. The circuits are designed to provide excellent performances. Altogether, fifteen circuits are constructed, including 11 receivers, 1 audio amplifier, and 3 transmitters. The sets start with simple circuits of 1 tube plus rectifier, gradually grow more complex, and finish with several examples of radio sets using three tubes plus rectifier.

**PROGRESSIVE RADIO KIT... ONLY \$14.75
SPECIAL FREE OFFER**

Electrical and Radio Tester sent absolutely FREE with each Progressive Radio Kit PLUS FREE membership in Progressive Radio Club. Entitles you to free expert advice and consultation service with licensed radio technicians. Write for further information or ORDER your KIT NOW!

**PROGRESSIVE
SCOOPS!**

FM COIL & CONDENSER KIT

Designed for operation on 88-108 MC (new band), contains 2 IF transformers, 1 Limiter Transformer, 1 Discriminator Transformer, 1 RF coil, 1 Variable condenser, Schematic and wiring instructions. Excellent for schools, experimenters and Radio Hobbyists.
Price only **\$4.95**

CONDENSER KIT

50 Paper Tubular Condensers. Values from .002 mfd to .1 mfd. 400 V. DC to 600 V. DC.
Only **\$1.95**

RESISTOR KIT

100 Carbon Resistors, 1/2 Watt., RMA color-coded. Values from 120 ohms to 2.2 megohms **\$1.50**

10-10 MFD. 450 W.V. DC Electrolytic Condensers **65c**

20-20 MFD. 150 W.V. DC Electrolytic Condensers **30c**

40-40 MFD. 150 W.V. DC Electrolytic Condensers **45c**

Antenna and RF Coil Set (Broadcast Band) **59c**

6" Alnico Slug Speaker... **\$1.69**

Selenium Rectifiers **79c**

Midget Soldering Iron 35 Watts 110/120 volts UL approved **69c**

55 Watt Soldering Iron UL approved **\$1.90**

75 Watt Soldering Iron UL approved **\$2.40**

Long Nose Pliers and Cutters **\$1.45**

PROGRESSIVE RADIO TOOL KIT

contains 75 Watt 110/120 Volt soldering Iron, long nose pliers & cutters, screwdriver, insulated alignment tool **\$3.25**

ESPEY CUSTOM-BUILT AM-FM HIGH FIDELITY RECEIVERS--Model No. 7-BC

- | | | |
|---|---|--|
| 1. AC Superhet AM-FM receiver. | 7. High-Fidelity AM-FM reception. | 12. Loop antenna for AM and Folded Dipole antenna for FM reception supplied. |
| 2. Frequency Modulation Circuit. | 8. Full-range combination bass-treble tone control. | 13. Provisions for external antennas. |
| 3. 11 finest quality tubes, including rectifier. | 9. 12 watt (maximum) Push-Pull Audio Output. | 14. Wired for phonograph operation. |
| 4. 2 dual purpose tubes give 15 tube performance. | 10. 10 inch PM speaker with Alnico V magnet. | 15. Licensed under RCA and Hazeltine patents. |
| 5. Automatic volume control. | 11. Indirectly illuminated "slide-rule" dial. | 16. RMA listed. |

Your Price **\$84.00**

\$25.00 deposit required with C.O.D. orders

WRITE FOR PROGRESSIVE QUANTITY PRICES
PROGRESSIVE ELECTRONICS CO., Dept. RC-14
497 UNION AVE. BROOKLYN 11, NEW YORK
We Pay Postage on Prepaid Orders. All C.O.D. Orders Shipped Collect.

GLOSSARY OF FM TERMS
(Continued from page 49)

voltage (for given frequency), and inversely with the audio frequency (for a given audio voltage). The modulation index is large at low frequencies and small at high frequencies (i.e., for a maximum frequency deviation of 75 kc, an audio frequency of 15 kc will have an index of 5; [75/15]. 1,500 cycles produces an index of 50; 150 cycles = 500, etc.) For the highest audio frequency (15 kc), the modulation index is called the deviation ratio.

nodes, nodal points. The points in an antenna system or transmission line where amplitude of a standing wave is zero. Points where the amplitude of a standing wave is at maximum are called antinodes or loops. Antinodes appear midway between node points.

peak shift, limiter. A shifting of the resonance peak of the limiter input transformer, due to the loading effect of signals strong enough to cause grid current flow.

phase distortion. The result of harmonics or multiples of range frequencies whose relative

phase angles have changed during the process of modulation.

phase modulation. The indirect method of obtaining frequency modulation. Consists of a crystal-controlled oscillator whose output is split into two paths, one containing a 90-degree phase-shifting network and the other a balanced modulator. A series of multipliers are used to increase both frequency and modulation index to the proper values. Phase modulation was the method first employed by Major Armstrong.

polarization, horizontal. Orientation of a transmitted wave so that its lines of force (electric field) are parallel to the ground. FM antennas are horizontally polarized, since this method gives improved noise rejection.

polarization, vertical. Wave orientation so that the electric field is perpendicular to the ground. (Elliptical polarization is a combination of vertical and horizontal fields; a certain amount may be said to be present in either plane.)

pre-emphasis. Deliberate transmitter equalization to increase voltages of high audio frequencies beyond their normal in order to improve the signal-to-noise ratio and to bring the modulation index up to that of low frequencies.

pylon. A cylindrical transmitting antenna, hav-

ing an opening or slit extending full length on one side.

ratio detector. A demodulator circuit which replaces both limiter and discriminator in FM receivers. Popular especially in lower-priced sets.

reactance modulator. A tube (or tubes) connected in shunt across the master oscillator plate tank. Application of audio voltage to the reactance grids varies the reactive plate current, causing the oscillator frequency to vary at an audio rate.

reflection coefficient. The vector ratio of a reflected ground wave to the original wave. Value depends on conductivity and dielectric constant of earth, frequency, and angle at which the wave strikes the earth.

reflector. An antenna element somewhat greater than 1/4-wave length, mounted on a dipole antenna to improve signal pickup and increase rejection to unwanted signals.

response, response curve. Output variation (with frequency) of an amplifier i.e., an amplifier flat within ±2db over the audio range is said to have good response. The response curve is plotted graphically with the aid of a calibrated audio oscillator.

service area, primary. The area in which reception is satisfactory under all conditions. Minimum field strength for primary reception in rural areas is 50 microvolts for FM stations. Due to threshold noise and static, primary field strength for AM stations is required to be 10 times this value, or 500 microvolts. Urban (residential) field strength requirement for both services is 2000 to 5000 microvolts.

service area, secondary. Area in which field strength falls below the values set for primary coverage. Reception is good under favorable conditions but poor under unfavorable conditions.

shot effect. Noise introduced into a receiver through a variation in electron emission from the cathode, usually originating in the grid and plate circuits of the first tube. When static and outside noises are of no consequence, the noise within a receiver is governed by shot effect and thermal agitation.

side bands. The frequencies which appear on each side of the center frequency as a result of modulation. Since these frequencies decrease in amplitude as their width increases, no side-band interference is likely outside the assigned channel.

signal-to-noise ratio. Ratio of the desired signal to background or superimposed noise in a receiver. The highest possible ratio is obtained when the only noise present in the receiver is that of thermal agitation in the input circuit.

sky wave. The part of the transmitted wave which travels skyward and is (usually) reflected back to earth by the ionosphere. At ultra-high frequencies the sky wave is virtually unaffected by ionospheric reflections, and hence is not normally reflected to earth.

space wave. The portion of the ground wave which is projected from the transmitting antenna toward the receiving antenna. It is dependent on two components, the direct wave and the ground-reflected wave.

special temporary authority (STA). Authority given by the FCC to operate on a temporary basis while conditions of a regular CP are being met or completed.

standing wave. The energy that exists at one or more points along a transmission line as the result of mismatch or improper termination. The ratio of standing waves depends on the amount of mismatch and the resultant strength of the reflected portion of the initial wave.

studio-transmitter link (STL). An ultra-high-frequency transmitter-receiver arrangement for connecting studio to transmitter where regular wire lines are undesirable or impractical. Since line-of-sight distances usually are involved, transmitter power requirements are very small. Beam antennas are employed.

surface wave. That portion of the ground wave which travels along the surface of the earth. Propagation at FM frequencies depends on both the surface and space components of the ground wave.

thermal agitation. Noise generated by the random motion of electrons within a conductor; usually introduced into a receiver through the first tube. It is important that thermal noises be kept to an absolute minimum in FM receivers.

turnstile. An antenna consisting of two half-wave sections crossed at right angles and fed 90 degrees out of phase. A number of these radiating sections may be stacked horizontally to increase antenna gain. Stacked sections are called bays.

turnstile folded dipole. A receiving antenna composed of two folded dipole sections crossed as a turnstile and fed as such. High efficiency, with non-directional characteristics, is possible with this arrangement.

wave guide. A hollow conducting tube used for transmission of ultra-high and micro-wave frequencies; employed in v.h.f. relay systems.

Weir stabilizer. A frequency control system using a standard crystal oscillator, mixer, discriminator, and detector to compare the difference voltage between standard and carrier frequency and feed the result to a frequency-correcting feedback circuit.

SENSATIONAL BARGAINS 'n WAR SURPLUS OPTICS

ASSEMBLE YOUR OWN BINOCULARS!

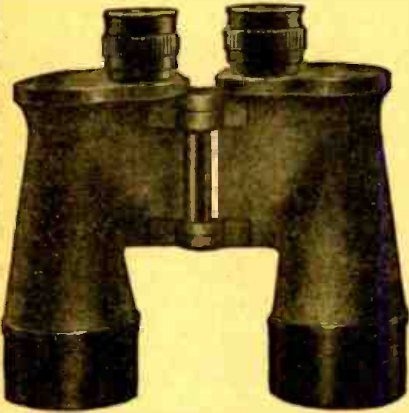

NOTICE! If you buy both the Binocular Optics and the Binocular Metal Parts, your purchase becomes subject to 20% Federal Excise Tax. Be sure to add amount covering tax to your remittance or your order cannot be filled.

Complete Optics! Complete Metal Parts
Save More than 1/2 Regular Cost

GOVT'S 7x50 BINOCULARS

Here's an unusual opportunity to secure a fine set of Binoculars at a substantial saving of money. Offered here are complete sets of Optics and Metal Parts for the 7x50 Binoculars. These components are new and all ready for assembly. We supply full instructions. Limit—1 set of Metal Parts and 1 set of Optics to a customer.

METAL PARTS—Set includes all Metal Parts—Completely finished—for assembly of 7x50 Binoculars. No machining required. Bodies have been factory hinged and covered. A sturdy Binocular Carrying Case is optional with each set of Metal Parts.

Stock #842-F...\$39.40 Postpaid, plus \$4.80 for Case—
Total\$44.20

OPTICS—Set includes all Lenses and Prisms You need for assembling 7x50 Binoculars. These Optics are in excellent condition—perfect or near perfect—and have new low reflection coating.

Stock #5102-F—7x50 Optics.....\$25.00 Postpaid

ARMY'S 6 x 30 BINOCULARS!

No Carrying Case with any Sets shown below.
COMPLETE OPTICS & METAL PARTS—Model M13A1. 6x30 Binoculars (waterproof model). Everything you need—ready for assembly. When finished will look like a regular factory job costing \$102 to \$120. The Optics are new, in perfect or near-perfect condition. Have new low reflection coating. Metal Parts are new and perfect, all completely finished. No machining required. Bodies factory hinged and covered. Complete assembly instructions included.

Stock #830-F.....\$40.00 Postpaid plus \$8.00 tax—Total—\$48.00

METAL PARTS ONLY—Model M-13A1. 6x30 Binoculars. No Optics. Same Metal Parts as described for Stock #830-F.

Stock #832-F—6x30 Metal Parts.....\$25.00 Postpaid

OPTICS FOR 6x30 BINOCULARS—(No Metal Parts). Perfect and low reflection coated.

Stock #5130-F.....\$15.00 Postpaid

SAME OPTICS AS ABOVE—Coated, but slight seconds, Stock #5124-F.....\$12.75 Postpaid

Optics and Metal Parts Are Available for Monoculars (1/2 a Binocular). For Complete Details, Write for Bulletin #14-F.

If you buy both the Binocular Optics and the Binocular Metal Parts, your purchase becomes subject to 20% Federal Excise Tax. Be sure to add amount covering tax to your remittance or your order cannot be filled.

POLARIZING VARIABLE DENSITY ATTACHMENTS FOR BINOCULARS—

An amazingly effective unit for controlling amount of light reaching your eyes. Cuts down glare in sky and over-water observations. Easily snapped on and off over the eye-cups of American-made 7x50 Binoculars. Govt. cost \$8.30 each.

Stock #20,000-F.....\$2.00 Postpaid

Above Polarizing Attachment also adaptable to Govt. 6x30 Binoculars with substitution of special eye-cups. Stock #20,010-F—6x30 Eye-cups......75 or. Postpaid

YOU CAN EASILY MAKE

Telescopes, Magnifiers, Photographic Gadgets and Hundreds of Experiments with these Low Cost Lenses.

To Translate Millimeter measurements: 25.4 mm. equals one inch.

TERRIFIC BARGAIN—BUBBLE SEXTANT

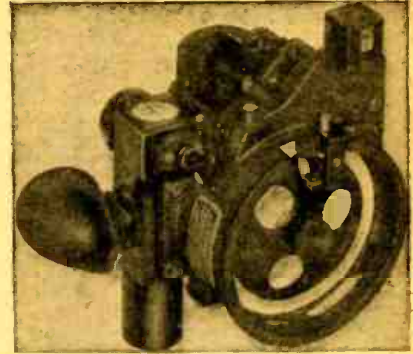

These Army Air Forces Bubble Sextants cost the Govt. about \$125 each. A real bargain at our price of \$12.50! Included with Bubble Sextant shipment is wooden Carrying Case, 5 spare waxed paper discs, flashlight with rheostat for night use (uses ordinary flashlight cells—not furnished) aux. 2-power Galilean Telescope Allen wrench, 1 spare marking point. Wartime used, BUT COMPLETELY REPAIRED, COLLIMATED AND PUT IN GOOD WORKING ORDER. Light bulb has been tested—Bubble is in working condition. Because of wartime use, we make this guarantee: If not satisfied that Sextant is exactly as represented, return within 10 days and money will be refunded. Full directions for use accompany each shipment.

Stock #924-F.....\$12.50 Postpaid

Same SEXTANT as above but BRAND NEW and with Automatic Electric Averaging Device and Illuminated Averaging Disc for nighttime use. Govt. cost \$217. Though brand new we have rechecked Bubble and Collimation and GUARANTEED perfect working order.

Stock #933-F.....\$22.50 Postpaid

CONDENSING LENSES—Seconds, but suitable for Enlargers and Spotlights.

Stock #1061-F—6 1/2" dia., 9" F.L.\$2.50 Postpaid

Stock #1080-F—5" dia., 7" F.L.\$1.50 Postpaid

We have a Limited Quantity of Condensing Lenses—seconds—ranging from 4 1/2" to 8 3/4" in dia. with various focal lengths. Send for Free Bulletin titled "MISCELLANEOUS CONDENSING LENSES—F"

35 MM. KODACHROME PROJECTING LENS SET—Consists of 2 Achromatic Lenses for projecting, plus 2 Condensing Lenses and piece of Heat Absorbing Glass with directions.
Stock #4029-F.....\$3.10 Postpaid

8 POWER ELBOW TELESCOPE



Govt. Cost \$200.00! Our Price \$17.50!
Big 2" diameter objective. All lenses Achromatic. Amici Prism erects the image. 4 built-in filters—clear, amber, neutral and red. Slightly used condition but all guaranteed for perfect working order. Weight 5 lbs. Can be carried but a trifle bulky.
Stock #943-F.....\$17.50 Postpaid

POLARIZING OPTICAL RING SIGHT

(Unmounted). Used in gun sights—especially for shot-guns. As you look through, you see a series of rings that you superimpose on your target. No front light required. Increases degree of accuracy.

Stock #2067-F.....\$4.00 Postpaid

CONDENSING LENS SET—Consists of 2 Condensing Lenses with diameter of 2". Used for making 35mm projectors or many other purposes.

Stock #4034-F......75 Postpaid

We have literally millions of war surplus lenses and prisms for sale at bargain prices. Write for catalog "F"—sent free!

SIMPLE LENS KIT—Some gov't surplus, some commercial surplus, some chipped rejects, some perfect, few coated. . . in any event an excellent bargain. Containing Plano Convex, Double Convex, Concave, Miniscus Lenses. Dia. range 5mm to 40mm. Assorted focal lengths.

Stock #5-F—45 lenses.....\$ 5.00 Postpaid

Stock #10-F—80 lenses.....\$10.00 Postpaid

Set #1-F—"Our Advertising Special"—15 lenses for \$1.60 Postpaid, plus 10-page idea booklet. For copying **ULTRA CLOSE-UP SHOTS**, microphotography, experimental optics, magnifying and for making a two power 7/16 Telephone Lens. "Dummy Camera." Kodachrome Viewer. **DETACHABLE REFLEX VIEWFINDER** for 35mm cameras, stereoscope viewer, ground glass and enlarging focusing aids, **TELESCOPES**, low power Microscopes and for many other uses.

NEW 50-PAGE IDEA BOOK "FUN WITH CHIPPED EDGE LENSES"

Contains wide variety of projects and fully covers the fascinating uses of all Lenses in sets listed above . . . only \$1.00 Postpaid.

LENS CLEANING TISSUE—1st quality, sheet size 11"x7 1/2". Made to govt. specs. Free of abrasives. High wet strength.
Stock #721-F—500 sheets.....\$1.00 Postpaid



MOUNTED PROJECTING LENS SYSTEM—F.L. 91.44 mm. (Just right for 35mm. Projectors). Speed of F1.9 Outside dia. of mount at one end of 60 mm. Length of mount 84 mm.

Stock #4033-F.....\$3.00 Postpaid

THREADED OUTSIDE MOUNT FOR FOCUSING ABOVE SYSTEM (Not illus.) Stock #715-F.
\$1.00 Postpaid

6 POWER GALILEAN TELESCOPE—(Commercial Surplus) 28mm dia. Achromatic Objective Lens. Sturdily constructed of Aluminum. 7" long, extends to 9". Complete with carrying case.

Stock #941-F.....\$3.00 Postpaid

\$200.00 DRIFT METER for \$5.60



These were used for determination of drift and true air speed. You can adapt to other uses or take apart to get two mounted Achromatic Lenses—Mirrors—Field Lens—Pantograph—Engraved Scales—Sponge Rubber Discs—metal parts and other components. Instrument weighs 4 lbs.

Stock #942-F.....\$5.60 Postpaid

AIR FORCES GUN SIGHT

With Polarizing Variable Density Attachment—Can be used as Slide Viewer, or take it apart and you can get Polarizing Variable Density Attachment, Mangan Concave Mirror, Reflector Plate, Metal Reticle, Window, Lamp Housing, Ring and Bead Sight. The Polarizing attachment alone is worth many times the price of entire unit. Consists of 2 Polarizing Filters mounted with small handle which rotates one around the other. May be used in Photography, Research, Experiments, as Light Dimmer, etc.

Stock #908-F.....\$5.00 Postpaid

Same unit Without Polarizing Attachment

Stock #916-F.....\$2.50 Postpaid

Order by Set or Stock No.

Satisfaction Guaranteed

EDMUND SALVAGE COMPANY - P. O. AUDUBON, NEW JERSEY

JUNE, 1948

TUBES GREATEST SELECTION IN COUNTRY
 LOWEST PRICES
 NEW—STANDARD BRAND—Min. Order \$5.00
 QUANTITY PRICES ON REQUEST

0A4G \$1.06	3C6 1.28	6N788	12DP7 14.95	4988	832A 2.95
0050	3C2469	6N7GT88	12F5GT59	50 1.56	833A 39.50
0Y488	3D689	6P5GT88	12M659	50A588	836 1.15
01-A50	3E29 2.95	8Q5G98	12J5GT54	50B572	837 2.50
02488	3FL4 1.06	608G/6T7G 1.06	12J7GT72	50L6GT59	838 4.95
1A372	3Q472	6Q772	12JPA 60.00	50X688	84169
1A4 1.28	3Q5GT88	6R788	12K7GT59	50Y6GT59	84369
1A4P 1.28	4-65A 14.50	6S788	12K859	5388	845 4.95
1A4T88	4-125A 27.50	6S8GT88	12Q7GT59	5572	850 3.00
1A5G 1.06	4-250A 37.50	6SA7GT59	12Q7GT59	5659	861 50.00
1A688	5BP1 1.49	6SC772	12SC772	5772	86469
1A7G 1.06	5BP4 4.95	6SD7GT72	12SF559	5872	866A89
1A85 1.28	5CP1 3.95	6SF559	12SF772	59 1.06	868 1.95
1B4 1.06	5FP7 3.95	6SH772	12SG772	70L7GT 1.56	872A 1.95
1B5/25572	5JPI 9.96	6S1759	12SH772	71-A72	874 1.95
1B7G 4.95	5R4GY 1.29	6SK759	12SK759	7559	876 4.95
1B27 4.95	5T4 20.00	6SL7GT88	12SL7GT88	75TL 2.95	88498
1B3888	5U4G54	6SN7GT88	12SN7GT88	7659	902 4.95
1C5G 1.06	5V4G88	6SQ754	12SQ759	7859	950 1.06
1C6 1.06	5W488	6SR759	12SR772	7988	95449
1C7G 1.28	5X4GT60	6SS772	12X398	8042	95549
1D5GT 1.06	5Y4G58	6ST788	12Z388	81 1.28	95675
1D7G 1.28	5Z380	6T7 1.06	14A4 1.06	8288	95749
1D8GT 1.56	5Z488	6U6GT88	14A5 1.56	8388	958A69
1E5GP 1.28	6A3 1.06	6V6 1.06	14A788	83V88	95949
1E7G88	6A3G 1.56	6V6GT72	14B5 1.10	85/6Z459	98150
1F488	6AG 1.06	6V7G72	14B888	8972	101395
1F5G 1.28	6AGG88	6V7GT72	14C588	89V 1.56	1014 1.75
1F688	6A772	6W7G88	14C788	99X 1.56	101929
1G4GT88	6AB5/6N5 1.06	6X454	14E672	100TH 12.95	1022 1.75
1G6GT88	6AB7 1.06	6X554	14E788	114A69	102498
1H4G 1.06	6AC5GT88	6Y6G88	14F788	117L7GT 1.28	102549
1H5GT 1.06	6AC7 1.06	6Z7G 1.28	14H7 1.06	117M7GT 1.28	102698
1H6G 1.28	6AD7G 1.06	6ZV5G72	14J7 1.06	117N7GT 1.28	1027 7.95
1I6G 1.06	6AF6G88	7A472	14K7 1.06	117P7GT 1.28	102959
1L4 1.06	6AF888	7A572	14Q788	117Z372	1042 4.95
1LA4 1.06	6AG5 1.06	7A672	14S7 1.06	117Z6GT88	1051 1.25
1L6G 1.06	6AG7 1.06	7A772	14R788	120A 12.95	105089
1LB4 1.06	6AJ590	7A872	14W7 1.06	121A 2.65	105149
1LC5 1.06	6AK599	7AE772	14X7 1.06	205B 4.50	1054 3.95
1LC6 1.06	6AK688	7AF772	14Y488	21198	1056 5.95
1LE3 1.06	6AL588	7B472	15A4 110.50	215A 3.00	10562 10.00
1LD5 1.06	6AL7GT72	7B572	15E 1.06	217C 7.50	1057 3.9
1LH4 1.06	6AO572	7B872	15E 1.06	250R 7.95	1059 4.95
1LN5 1.06	6AO672	7B772	20 1.56	250TH 19.50	1061 2.95
1NSG 11.50	6AQ580	7B872	20AP4 270.00	252A 4.95	1012 4.95
1P2288	6AT670	7B772	22 2.95	259A 4.95	1016 1.95
1P5GT88	6AU980	7C4 1.06	23D449	304TL 1.98	1020 5.95
1Q5GT 1.06	6B4G 1.06	7C572	23D898	307A 6.25	1025 3.95
1R4 1.06	6B6G72	7C672	24A72	310 3.10	100188
1T488	6B7 1.06	7C772	24G69	316A 3.16A	100288
1T5GT72	6B8 1.06	7E5/1201 1.06	25A8 1.06	350B 4.95	100349
1U472	6B9 1.06	7E688	25A7GT88	394A 4.50	100449
1U588	6BA672	7E788	25C6G 1.06	417A 19.95	100598
1-V 1.06	6BE6 2.40	7EP4 17.95	25L6GT59	450TL 24.95	100698
2A372	6C460	7F788	25Y5 1.28	531 49.50	CEQ72 1.95
2A588	6C560	7F8 1.06	25Z554	701A 4.95	CK100539
2A688	6C660	7G7 1.06	25Z6 1.06	703A 7.50	CK100669
2A7 2.95	6CG 1.06	7GP4 19.40	2659	705A 7.05A	EF5079
2API88	6DA 1.95	7H788	2754	707A 24.95	EM14859
2B788	6D680	7J7 1.06	28D7 1.06	709A 9.95	FM-1000 1.56
2C2269	7E572	7K7 1.06	3072	713A 1.86	GL434 4.95
2C26A98	6F560	7L788	3188	715B 18.95	GL446A 2.60
2C34 2.60	6F6G72	7N788	32 1.06	717A 1.85	MF100 3.95
2C43 2.60	6F672	7Q772	32L7GT 1.28	721A 3.95	HY89 2.95
2C44 1.75	6F7 1.06	7R788	33 1.06	723AB 5.95	HY75 1.25
2D21 1.89	6F8 1.06	7S7 1.06	34 1.06	725A 12.50	HY815 1.25
2E588	6H588	7V7 1.06	35/5172	750TL 49.50	MYE1148 1.25
2E22 1.50	6H6G60	7W7 1.06	35A572	800 2.25	RK12 1.95
2E24 4.37	6J4 3.95	7X7 1.06	35L6GT59	801A 1.10	RK22 4.95
2E25 2.25	6J554	7Y472	35W448	802 2.95	RK6079
2E30 4.85	6J5GT54	10BP4 34.95	35Y488	803 8.95	RKR72 3.50
2V351 1.10	6J6 1.06	10CP4 42.20	35Z372	805 4.95	RK73 3.95
2V3G 1.49	6J772	10HP4 49.50	35Z4GT50	807 1.25	T20 1.95
2X288	6J8GT72	10Y69	35Z5GT46	808 2.95	VL225 2.95
3A472	6J9G 1.06	12A689	3788	80988	VR75 6.85
3A3GT 1.92	6K5GT88	12A7 1.06	3872	81172	VR7878
3API 2.95	6K6GT54	12A8GT72	39/4459	812 2.95	VR9075
3B7 1.06	6K788	12AH7GT88	4159	812H 6.50	VR10575
3B22 4.95	6K888	12AT659	4259	813 7.95	VR15075
3B23 4.95	6L5G88	12AU672	4359	814 5.95	VT127A 3.00
3B24 1.95	6L6 1.29	12AU788	4559	815 1.25	VU111 1.50
3B2596	6L7G 1.06	12BA672	45Z5GT59	826 2.50	WE532A 4.95
3BP1 2.95	6L888	12BE872	4688	829B 4.95	Z225 1.95
		12C889	4788	830B 5.25	

20% DEPOSIT WITH ORDER UNLESS RATED

ALL TYPES LISTED ABOVE IN STOCK NOW BUT SUBJECT TO PRIOR SALE

NIAGARA RADIO SUPPLY CORP. 160 GREENWICH ST. NEW YORK 6, N. Y.

FM RECEIVERS

(Continued from page 24)

and the 6.2- to 9-mc and 12- to 17-mc short-wave bands. This section shares its first a.f. amplifier and tuning indicator with the FM section. There is a special bass-boost a.f. amplifier on the tuner chassis. The power amplifier and power supply are on a separate chassis. Output is 20 watts, to a co-axial speaker.

The REL Model 646 is a dual-band FM receiver designed primarily for demonstrating and station monitoring.

It uses eight tubes in the r.f. section and has two panel-mounted meters—one used as a field strength meter and the other as a tuning indicator. It includes a 10-watt a.f. amplifier on a separate chassis.

The Model 648 is a similar set designed for use in a vehicle with a 6-volt d.c. supply. This set is for use in making mobile field-strength surveys.

The National Model NC-108R, a set

in a standard rack-mounting panel, is also designed for monitoring and commercial applications.

It is a straight FM receiver using 10 tubes including rectifier. It uses one stage of r.f. amplification, separate mixer and oscillator tubes, a 3-stage i.f. amplifier, a ratio detector and a 2-stage a.f. amplifier with a meter tuning indicator and a built-in 5-inch PM speaker.

A variation is the NC-108T. It is mounted in a metal cabinet, with a tuning eye replacing the meter. The manufacturer calls these sets receiver-tuners and recommends their use with an external amplifier and speaker for best reproduction.

FM TUNERS

(Continued from page 29)

pear to be notable, as—tube for tube—the Edwards was somewhat more sensitive than the average of the tuners tested and the Approved somewhat less so.

Most of the rest of the tuners use standard coil-condenser combinations, with such variations as brass-plate tuning condensers to minimize drift. The Brooks FMT-10, however, has a permeability-tuning system, varying the frequency with movable brass cores in the r.f., mixer, and oscillator circuits.

Another outstanding feature is the double superheterodyne circuit. It is found in most of the larger tuners without an r.f. stage. In this circuit, the oscillator operates at half the input frequency minus half the intermediate frequency. The incoming signal is thus heterodyned to half the input frequency plus half the intermediate frequency in the first converter tube (or the first half of a double-triode converter). This frequency is then heterodyned by the same oscillator to exactly the intermediate frequency in the second converter tube or section.

The Browning (one of the first on the market), one of the Collins Audio, the Dongene, the Espy, and some Meissner models are combination AM-FM tuners. Some of these have completely separate AM and FM tuners; others combine the i.f. channels. The Meissner 3-1093 and the Browning RJ-12 were constructed without power supply, obtaining their voltages from the amplifier with which they were intended to be used, or from an external pack. Both companies find it worth while to supply self-powered tuners, the 9-1091 and RV-10, respectively. Collins Audio Products, and possibly others, have done the same.

A feature phonograph users may well look for is the phono-FM switch provided in a few of the models. The phonograph is attached to the tuner, a switch permitting selection of either FM or phonograph operation.

Another departure from the beaten track is the De Wald tuner, which does not require any attachment to the receiver. Its output is an oscillator similar to that of a wireless record player. While such a device cannot reproduce the high fidelity of FM transmission, since it transforms the signal to AM,

it may be useful in special applications where it is not desired to disturb an existing set to add a phonograph input and where interference and electrical disturbances make FM reception (even with only AM quality) desirable.

Characteristics of the more commonly available FM tuners are given in the table. Only the FM channels of AM-FM tuners are considered. Rectifier or indi-

cator tubes are not counted in the "number of tubes" column, though they are listed in addition to the functional tubes. Where a separate oscillator is used in the mixer circuit, it appears directly below the mixer tube. Two mixer tubes indicates a double superheterodyne. Abbreviations are: selen., for selenium rectifier; and F-S, for Foster-Seeley discriminator.

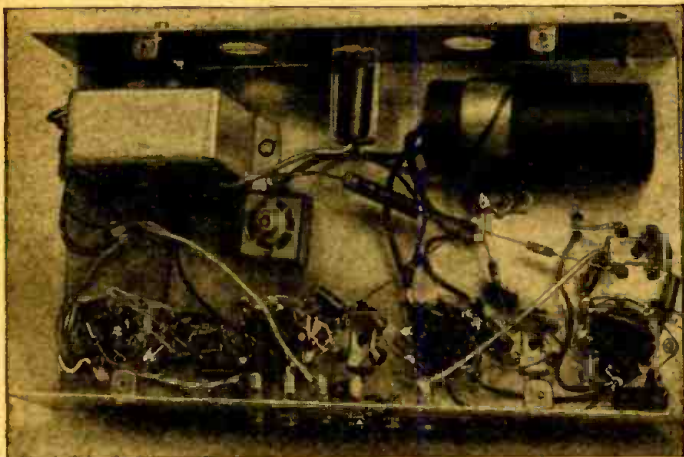

Under-chassis view of Edwards Fidelotuner, showing the selenium rectifier. The long-lines tuning apparatus is above the chassis.

FM FUNDAMENTALS
(Continued from page 21)

line. Transmission depends on the space wave.

High-fidelity reproduction

The useful audio-frequency range extends from about 20 to 15,000 cycles per second. For good fidelity in reproduction, a broadcast station must be capable of handling all these frequencies. Instruments such as the snare drum, violin, piccolo, and oboe, and even hand clapping, require the full range. Since AM stations are assigned to channels only 10 kc apart, high-fidelity transmission at broadcast frequencies is out of the question. Network lines and most remote lines are equalized to cut off all frequencies above 5,500 cycles per second.

FM channels are 200 kc wide, and stations are allowed a maximum swing of 75 kc on either side of the center frequency. This leaves a spare 25 kc at either end to serve as a guard band to prevent adjacent channel interference. The wide channel permits broadcasting the entire audio range.

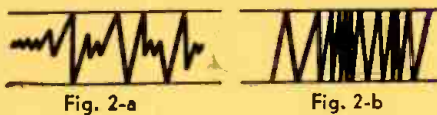

The signal strength of an AM station varies with modulation (Fig. 2-a), reaching its peak at 100% and decreasing correspondingly with lower levels of modulation. Noise may cover the softer passages of sound completely when the

carrier power is low. FM carrier power remains constant at all times (Fig. 2-b), the power merely being distributed in the side bands on modulation. In AM systems, 100% modulation refers to the maximum or peak amplitude allowed; in FM, it refers to the maximum frequency swing.

To meet the high-fidelity requirements of FM, all station equipment must be capable of passing the entire audio range with very low distortion and noise levels. Total distortion in modern equipment is kept to approximately 1.5 db, and the noise level 65 db below program level, or better. Frequency response is flat over the entire range to within ± 1 db.

Rebroadcasting does not introduce feedback or heterodyne effects. A group of stations can be linked to form a network of any size, the only limiting factor being the distance between stations. Each successive station must be within reliable receiving range of its predecessor.

Other FM advantages

As previously mentioned, the carrier power of an FM station remains constant. This allows the tubes to be run closer to their recommended operating characteristics, and efficiency is increased, especially in the final r.f. stages where an efficiency of close to 70% can be maintained.

Due to FM's superior ability to conquer interference and static, a lower-

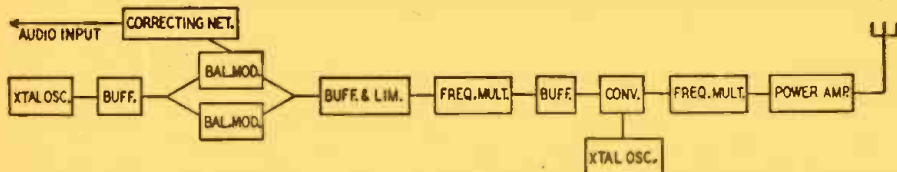

Fig. 3—Block diagram of FM transmitter using the Armstrong indirect method of modulation.

free radio book

RADIOS FOR HAM P.A.

Spot-lite Values

25 Ceramicon Condensers



Provide ultimate stability. Temperature coefficient is determined by the ingredients of the ceramic di-electric; controllable to within very fine limiting values. Color coded. Flexible pigtail leads. Shpg. wt. 1 lb.

AP5511—Your Cost..... **69c**

Crystal FM Converter

Change old FM (40-50 MC) to new FM in a few moments and at lowest cost. Efficient operation; this is a superior device. No loss of signal. Easy to install.

AP5700—Your Cost **\$6.00** Only



from Lafayette

MAIL-NOW

New York
100 SIXTH AVE
110 Federal St., Boston 30
24 Central Ave., Newark 2

Lafayette Radio

RADIO WIRE TELEVISION, INC.
Dept. JF-8, 100 Sixth Avenue, N. Y. 13

Send No. AP5511 @ 69c each quantity ()
No. AP5700 @ \$6.00 each quantity ()

Enclosed: Check () money order ()
Send Catalog () New Flyer C42 ()

Name
Address
City Zone State

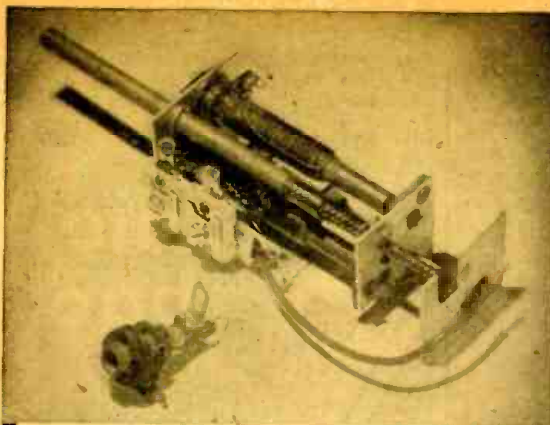

SET-BUILDER'S SCOOP!

**Tuning Unit --
Newest Type,
Permeability**

Complete, including separate iron core oscillator, tracking coil, and built-in mica trimmers. May be used to cover the broadcast band in either AC or AC-DC receivers. Has worm gear drive for iron slugs, rigid metal frame only $1\frac{3}{8}$ " x $1\frac{3}{4}$ " x $3\frac{7}{8}$ ". Extra long tuning shaft. Moisture proof coils wound on plastic forms.

Nothing equal at twice the price. Full instructions included. Shipped C.O.D. or postpaid with cash order within U. S. A. **\$1²⁵**

WATTERSON SALES CO.

P. O. BOX 840

DALLAS 1, TEXAS

FM FUNDAMENTALS

(Continued from page 53)

power transmitter, with greatly reduced operating voltages and cooling requirements, can be used. This reduces overall operating expenses. Costs can be lowered still further by using an antenna system with a power gain as high as 6 or 8.

The modulation system employed in FM transmitters also represents a saving. In AM, the carrier power is increased 50% under 100% modulation, and four times on peaks. The cost of the additional power is high, especially large stations. Since an FM transmitter is modulated in the oscillator stage, the modulator unit employs inexpensive receiving-type tubes.

This discussion would hardly be complete without describing the methods of generating FM waves. Two basic systems are now in use: the indirect or Armstrong method, and the *direct* method. The indirect system (Fig. 3) consists of a crystal-controlled oscillator whose output is split into two paths, one of which is fed through a 90-degree phase-shifting network, and the other contains a balanced modulator. When these two paths are again combined, the result is a phase-modulated signal, linear up to ± 30 degrees. The frequency deviation, however, is very small. The necessary 150-kc swing is obtained by multiplying the oscillator output to a high frequency. This frequency is then reduced to a low value by heterodyning it with a second crystal oscillator. It is then put through another series of multipliers to raise it to the final frequency. This system allows a higher order of frequency swing than if simple frequency multiplication is used.

In the more simple direct method of frequency modulation, a reactance tube controls the master oscillator, which usually operates at one-sixteenth the output frequency. The oscillator output is fed through multiplier and buffer stages to the final power amplifier.

Automatic frequency control

To control the transmitter frequency, a portion of the oscillator's output voltage is passed through a chain of frequency dividers until the frequency reaches a very low value (5,000 cycles in one commercial transmitter). A temperature-controlled crystal oscillator is used as a frequency standard. Its output is also passed through frequency dividers until its frequency is identical to that from the first chain of dividers. The outputs of both divider systems are then applied to balanced modulators whose outputs are 90 degrees out of phase. Each output is amplified and (in one system) applied to separate windings of a 2-phase inductor motor whose shaft is connected to a frequency-compensating capacitor in the tank circuit of the modulated oscillator. Any difference between the center frequency of the modulated signal and the crystal standard produces a beat frequency whose direction of drift operates the motor to adjust a compensating circuit.

the radio that
AMAZES
even the
EXPERTS



There is no other radio like Hallicrafters precision-made Model S-38. Four bands bring you thrilling land, sea, air communications from all parts of the world plus finer quality on your favorite broadcast program. Perfect for den, library, office. Extra clear, strong reception anywhere. AC/DC. Write for Catalog P38 and where to buy.

Model S-38... **\$47⁵⁰**

hallicrafters RADIO

Get a Hallicrafters and listen for the Gatti-Hallicrafters mobile, radio-equipped expedition now operating via short wave from the Mountains of the Moon, Africa.

THE HALLICRAFTERS CO.
4401 W. Fifth Ave., Chicago 24, Illinois

How to repair RADIOS . .

**This manual shows you
how to handle 95%
of all service problems**

Here's a highly practical radio repair manual which leads you in easy steps to a complete understanding of 95% of all radio servicing jobs. It covers the modern superheterodyne A.M. receiver, as well as phonograph-combination service problems and auto radio problems. Detailed "how-to-do-it" explanations enable you to put your finger on exactly what needs to be done.

ELEMENTS OF RADIO SERVICING

By William Marcus, co-author of "Elements of Radio" and Alex Levy, Instructor of Radio Mechanics, Manhattan Trade Center for Veterans and Chelsea Vocational High School.

471 pages, 6 x 9, Illustrated, \$4.50.

This radio servicing handbook is easy-to-read and easy-to-understand. It breaks the superheterodyne into natural stages, and analyzes it thoroughly from a service standpoint, covering everything from setting up the signal generator to the push-pull output stage. Attention is given to the most commonly used testing equipment—the multimeter and signal generator. Schematic diagrams help make this book a practical on-the-job manual.

10 DAYS' FREE EXAMINATION

McGraw-Hill Book Co., Inc., 330 W. 42 St., N.Y.C. 18
Send me Marcus and Levy's Elements of Radio Servicing for 10 days' examination on approval. In 10 days I will send \$4.50, plus a few cents postage, or return book postpaid. (Postage paid on cash orders.)

Name
Address
City and State
Company
Position RC-6-48

A very effective method for producing frequency modulation uses balanced reactance tubes. The RCA BTF-3B FM transmitter employs this system. A modulated Hartley oscillator is link-coupled to the grid circuit of push-pull reactance tubes. The r.f. voltage appearing on each grid is 180 degrees out of phase with the opposite grid, and 90 degrees out of phase with its respective plate. One reactance tube produces a plate current which leads its plate voltage by 90 degrees and functions as a capacitive reactance across the modulated oscillator. The other tube's plate current lags its plate voltage by 90 degrees and acts as an inductive reactance across the oscillator tank. Since the plate current from these tubes is directly proportional to the amplitude of the audio-frequency signals impressed on their grids, the result is a proportional change in frequency of the modulated oscillator at an audio rate.

FREQUENCY MODULATION

(Continued from page 20)

of all upon the manufacturer.

It is on the operations of the manufacturer that the spotlight of public opinion is now focused. For over two years, as everyone knows, the efforts of a very large part of the industry have been centered on the manufacture and sale of equipment that is already obsolete; that is, AM sets without an FM band. A small part of the industry is engaged in practices which bid fair to bring back the days of the "blooper"—sets which oscillated directly into the antenna. And there have been still others who have engaged in the equivalent of selling an automobile without a gearshift, i.e., an "FM" set without proper noise-suppressing facilities.

All these things the public will find out in due course. They will then turn to the sets of the manufacturers which give them genuine FM performance. But why put a substantial part of the public to all that trouble and loss?

Is it not time that the radio industry cultivated a sense of responsibility to the public? Is it not time, if they fail so to do, that their responsibilities be pointed out to them by the editors of the trade and technical journals so clearly that they cannot fail to understand them?

All the old-timers remember that when the Superheterodyne was invented there were a flock of devices known as *Infradynes*, *Ultradynes*, *Superdynes*, etc., but that eventually the art standardized on the basic Superheterodyne principle. So it will, of course, be with the FM system. Whether the manufacturing industry has learned that lesson or whether it will have to learn it all over again will be made clear within the coming year.

The opportunity, however, to give to people a service infinitely better than they have had since broadcasting started is here, and history will record how well the receiver manufacturers took advantage of the opportunity which has been laid on their doorstep.

JUNE, 1948



TRIAL OFFER!

TO INTRODUCE THE NEW

"AKRAD" CONDENSER

TOUGH INSULATION!
AKRADS resist "shorts" till the cows come home. New INSULATING FILM takes voltage surges without puncturing.

SUPER-SEALED!
AKRADS are sealed in ALUMINUM TUBES, and the leads are SECURELY ANCHORED.



EXCLUSIVE WITH OLSON!
The AKRAD Condenser is our baby, developed after years of research. Sold ONLY by OLSON Radio Warehouse!



PLEASE:
Only ONE Akrad to a customer at this special low price. You must use the coupon. No orders outside USA. Offer expires AUG. 1, 1948.

EXTRA VALUE!
AKRADS are manufactured so efficiently and in such great QUANTITY that we save on the cost, AND SO DO YOU.

WHY DO WE MAKE THIS OFFER? Well, we think the AKRAD Condenser is TERRIFIC and we think you'll agree after you try one. Watch the OVERLOADING an Akrad will take without breaking down; check the long SHELF LIFE of an Akrad. We back up every AKRAD Condenser with a 100% GUARANTEE—so get one NOW from OLSON, the Radio Parts King of America. A REAL INVESTMENT for only a DIME!

VALUABLE COUPON!

SEND THIS COUPON WITH ONLY 10c TO

OLSON RADIO WAREHOUSE INC.

73 E. MILL ST., DEPT. 123 AKRON, OHIO

—and you will receive one 8 MFD 450 V. "AKRAD" CONDENSER. Hurry!
Offer expires AUG. 1, 1948.

NAME _____ (PLEASE PRINT)

ADDRESS _____

CITY _____ STATE _____

RADIOMEN'S HEADQUARTERS -||- WORLD WIDE MAIL ORDER SERVICE!!!

BUFRAD CAR RADIO ANTENNAS

All of our car radio antennas are made of triple plated Admiralty Brass Tubing, complete with low loss shielded antenna leads and high quality fittings.
SIDE COWL—BR-1, 3 sections extend to 66". Your price—single units—\$1.50; in lots of 12—\$1.35 ea.
SKYSCRAPER—BR-2 has 4 heavy duty sections that extend to 98". Your price—single units—\$2.45; in lots of 12—\$2.25 ea.
TILT ANGLE—BR-3, may be adjusted to all body contours. 3 sections extend to 66". Single unit price—\$1.50; 12 lot price—\$1.25 ea.
VERSATILE—BR-4, single hole fender or top cowl mounting may be adjusted to conform with all body contours. 4 sections extend to 56". Single unit price—\$2.90; 12 lot price—\$2.75 ea.
THE MONARCH—BR-5, single hole top cowl mounting, 3 sections extend to 56". Single unit price—\$1.90; 12 lot price—\$1.75 ea.
AFTER SEEING OUR ANTENNAS AND COMPARING, YOU WILL NEVER BUY ANY OTHER MAKE!

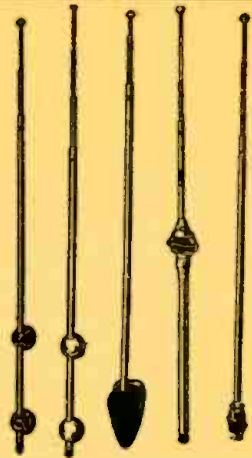

BR1 BR2 BR3 BR4 BR5

BENDIX SCR 522—Very high Frequency Voice Transmitter-Receiver—100 to 156 MC. This job was good enough for the Joint Command to make it standard equipment in everything that flew, even though each set cost the Gov't \$2500.00. Crystal Controlled and Amplitude Modulated—**HIGH TRANSMITTER OUTPUT** and 3 Microvolt Receiver Sensitivity gave good communication up to 180 miles at high altitudes. Receiver has ten tubes and transmitter has seven tubes, including two 3Z2's. Furnished complete with 17 tubes, remote control unit, 4 crystals, and the special wide band VHF antenna that was designed for this set. These sets have been removed from unused aircraft and are guaranteed to be in perfect condition. We include free parts and diagrams for the conversion to "continuously variable frequency coverage" in the receiver.
 The SCR 522 complete with 24 volt dynamotor sells for only \$37.95. The SCR 522 is also available with a brand new 12 volt dynamotor for only \$42.95.

AUTO RADIO DEALERS! ATTENTION!

Nationally advertised brand of 1948 car radio which will fit practically any car and every pocketbook. Six tube superheterodyne with three gang condenser and 6 1/2" speaker. \$32.20 for sample, or Dealer price \$29.97 each, in lots of two or more.
 Here is an item that no serviceman who repairs auto radios should be without. Nationally advertised ATR battery eliminator that supplies perfectly filtered 12 VDC or 6 VDC at 14 amps, from 110 AC.\$36.00

FLUORESCENT LIGHT BALLASTS. Single 80 or 40 watt, \$1.66; Dual 40 watt High Power Factor—\$3.75.
HEADPHONES—Highest quality Signal Corps headsets with 12' cord and plug \$1.25. 5' rubber covered patchcords with phone plug and socket—45c.
LINE FILTERS—110V—each unit contains two 2 mfd. oil filled condensers and a 15 amp. iron core choke. This filter has innumerable uses such as oil burner line filter, etc. A ten dollar value for 96c.
SELENIUM RECTIFIERS—Dry disc type 1 1/2", 1", 1.2 AMP. maximum, suitable for converting DC relays to AC, for supplying filament source in portable radios, converting DC meters to AC applications, and also may be used in low current chargers—90c.

FILTER CHOKES: 200, 300, 400, 500 ohm light duty—59c; 200 or 300 ohm heavy duty—99c; 250 ma 35 ohm, made for U.S. Navy, fully shielded—\$1.98; 75 ohm 125 ma—25c or 25 for \$4.25; "Molassner type" tapped filter chokes—25c; 8 amp. iron core A filter—25c; Choke-condenser combination. Ideal to replace any size speaker field when installing PM speaker—79c.
110V. CIRCUIT BREAKERS of Magnetic type: Following Current Ratings in Stock: 1.25, 3, 4, 8 Amps. Please specify, \$1.95 each.
SEVEN ASSORTED I.F. TRANSFORMERS—\$1.98; Five Assd. Oscillator Coils—69c.
METER RECTIFIER—Full wave, may be used for replacement, or in construction of all types of test equipment—\$1.25. Half Wave—90c.

1948 MODEL MUTUAL CONDUCTANCE TUBE TESTER.\$49.95

No possibility of good tubes reading "Bad" or bad tubes reading "Good" as on dynamic conductance testers or other ordinary emission testers. Attractive panel and case equal to any on the market in appearance. Large 4 1/2" meter. Calibrated micromho scale as well as a Bad-Good scale. ... Front panel fuse. ... Individual sockets for all tube base types—voltages from .75 volts to 117 volts and complete switching flexibility allow all present and future tubes to be tested regardless of location of elements on tube base. ... Indicates gas content and detects shorts or opens on each individual section of all octal, octal and miniature tubes including cold cathode, magic eye and voltage regulator tubes as well as all ballast resistors. Name of the nationally known manufacturer withheld because of special price offer.
 Model "C"—Sloping front counter case\$49.95
 Model "P"—Handsome hand-rubbed portable case 54.95
 Built-in roll chart with either of above \$5.00 extra.



POWER TRANSFORMERS—Half-shell type, 110V. 60 cy. Centertapped 11V winding. Specify either 2.5 or 6.3V filament when ordering.
 For 4-5 tube sets—650V. 40MA. 5V & 2.5 or 6.3V\$1.49
 For 5-6 tube sets—650V. 45MA. 5V & 2.5 or 6.3V 1.75
 For 6-7 tube sets—675V. 50MA. 5V & 2.5 or 6.3V 2.00
 For 7-8 tube sets—700V. 70MA. 5V & 6.3 or two 2.5V 2.35
 For 7-8 tube sets—700V. 70MA. 5V & 6.3 (25 Cycle) 3.60
 For 8-9 tube sets—700V-90MA. 5V-3A. 2.5V-3.5A. 2.85
 2.5-10.5A 2.85
 For 9-11 tube sets—700V. 5V & 6.3V-4A. 2.85
 For 9-15 tube sets—60V. 150MA. 5V & 6.3V 2.95
CONDENSERS—PAPER TUBULAR 600 WV—001. 002. 005—0c. 01. 05—9c. 1—10c. 25—23c. 5—35c. **ELECTROLYTICS:** 8mfd 200V—20c; 10mfd 35V—20c; 30mfd 150V—23c; 20/20mfd 150V—35c; 30/20 150V—46c; 50mfd 150V—43c; 8mfd 475V—34c; 16mfd 350V—65c; **OIL CONDENSERS:** 4mfd 600V 49c; 2mfd 600V—29c; 3X. 1mfd 600V—29c.
SPEAKERS—These PM speakers are the finest that are available All have heavy oversize Alnico V magnets.
 3 1/2" \$1.15 6 for \$6.60
 4" \$1.15 6 for \$6.60
 5" \$1.10 10 for \$9.50
 6" \$1.50 6 for \$8.70
 7" (Car Radio Size) \$4.50 6 for \$21.50
 8" 10 oz. \$3.95 6 for \$23.50
 8" 21 oz. \$4.95 6 for \$29.50
 10" 21 oz. \$5.50 6 for \$33.00
 12" 21 oz. \$7.95 6 for \$47.00

MICROPHONES—All nationally known brands. Bullet crystal—\$5.45; Bullet Dynamic—\$7.45; Mike Jr.—60c; Handy Mike—90c; Lapel Mike—93c; **SHURE T-17 MIKES**, with push to talk switch—99c.
20 ASS'D COIL FORMS, including 11 ceramic, 3 polystyrene, and 6 fiber, all useful sizes—50c.
VARIABLE CONDENSERS: 350 MMFD. 5 gang—\$1.95; 4 gang—\$1.49; 3 gang—83c; 7.5 to 20 MMFD. 1750v spacing, extra long shaft Hammarlund—69c; miniature variables, 25 MMFD—29c; 140 MMFD—79c; 75 MMFD—59c; 100 MMFD—39c; 50 MMFD—49c.
INTERRUPTION FREQUENCY COILS (or super-regenerative receivers or the tremendously popular FM adapters for standard broadcast sets. Iron core with a resonant frequency of 50 KC—39c; Air Core, 100 KC—29c.
30 MC IF TRANSFORMERS, double slug tuned—25c.
30 MC VIDEO AMPLIFIER PLATE COILS—Slux tuned—25c.
REMOTE CONTROL UNIT: Aluminum case 4x3x2" containing 2 potentiometers, triple pole switch, 4 knobs, gear mechanism, counter and phone jacks—59c.

AT LAST YOU CAN AFFORD A LABORATORY STANDARD MICRO VOLTER

The famous Measurements Corp. Model 78E. 5 Tube Laboratory Standard Signal Generator (that sold new, FOB Boonton, N. J., for \$310.00 net) is available in perfect condition for 25 to 60 cycle, 115 V AC operation. Until now this is the sort of topflight lab equipment that discriminating buyers have only vainly hoped would be released at a bargain price. Worth every cent the manufacturer asks, but available FOB Buffalo while our limited supply lasts for only \$59.95.
 Such companies as Admiral Corp. and John Meck, Inc., have ordered from us and repeated many times on these 78 generators for use in their labs and production line testing.
 Model 78-E Standard Signal Generator.



"REMEMBER THAT A STANDARD IS ONLY AS RELIABLE AS ITS MAKER."

RT-1579 consists of a three stage cascade 6BJ7's and 6F6 output stage high gain, high fidelity amplifier with 60 cycle, 110V power supply on the same 19 1/2 x 14 1/2 chassis, which is protected by a substantial steel cover over tubes and parts. Made by Western Electric with typical quality components such as a husky power transformer and oil condensers, this unit is obviously intended to give years of trouble-free service with no more need for repairs than a telephone. Disconnecting one wire each, from the special input and output filters, will result in as high a fidelity amplifier as can be obtained. Your cost with tubes, diagram and parts list included—\$14.95.
RT-1653—11 tube crystal controlled superhet receiver for 24-28V DC operation. Beautiful chassis and cabinet. Uses latest tube types including 7 miniature 6AJ5's. Tubes and schematic supplied. Only a few available at\$14.95

CLOSING OUT THE FOLLOWING DESIRABLE ITEMS AT SACRIFICE PRICES TO MAKE ROOM IN OUR WAREHOUSE FOR INCOMING STOCK

AIRPLANE INTERCOM AMPLIFIER—Complete with 4 tubes in aluminum case.\$4.95
"SO" RADAR P.P.I. SCOPE, complete with 9 tubes, Selsyn motor and self-contained 110 V power supply designed to run on the AC supply on LST and PT boats. Various ranges from 2 to 80 miles. The most satisfactory scope available for navigational radar or panoramic television applications. Nationally advertised as surplus at \$100.00 by others. Our price only \$39.95
AIRCRAFT MARKER BEACON RECEIVER—Complete with dual purpose tubes and sensitive relay to control external circuits from received signals. Just the receiver you have been waiting for to control models, open doors from a distance, etc. **PRICED AT only \$6.95**

SELENIUM RECTIFIERS. The new miniature rectifier that more and more manufacturers are using. Order some of each type so you will be ready when these receivers require servicing. Make extra money by installing them in old sets. All types are rated at 130 V.A.C.

25 MA\$.45	10 For\$ 4.00	50 For\$31.00	100 For\$60.00
75 MA70	10 For6.50	50 For32.50	100 For59.00
100 MA75	10 For7.00	50 For35.00	100 For65.00
150 MA80	10 For7.50	50 For47.50	100 For90.00
200 MA1.05	10 For10.00	50 For57.50	100 For110.00
250 MA1.25	10 For12.00	50 For		100 For	

DO NOT ASSORT TO MAKE QUANTITY

Cable Address: BUFRAD

Minimum order \$3.00—All prices subject to change—25% deposit with C.O.D. orders

BUFFALO RADIO SUPPLY, 219-221 Genesee St., Dept. 6 C. BUFFALO 3, N. Y.

RADIO-CRAFT for

RADIOMEN'S HEADQUARTERS WORLD WIDE MAIL ORDER SERVICE!!!

DUE TO POPULAR DEMAND WE REPEAT THESE TERRIFIC BARGAINS

- Three assorted new MICROPHONES, including push-to-talk type\$1.49
- Ten assorted R. F. Chokes including high frequency types\$.35
- Five assorted AUDIO or FILTER CHOKES\$.99
- One Hundred assorted RESISTORS\$1.95
- Ten assorted JAN CABLE CONNECTORS, including SCR274,522 and BC375 types\$.99
- Six assorted OIL FILLED CAN TYPE CONDENSERS, all with mounting brackets.....\$1.49
- Ten assorted METAL & BAKELITE KNOBS—(no wooden knobs)\$.39
- Six assorted VARIABLE CONDENSERS, including butterfly types\$1.49
- Six assorted POWER and AUDIO TRANSFORMERS, all new\$1.98
- Six assorted isolantite and bakelite R. F. COILS, shielded and unshielded\$.99

The above ten assortments totaling over \$12.00 at the unbelievable bargain prices listed can be purchased together as one lot at a super-special total price of only \$10.00. All merchandise guaranteed to be as advertised.

RT1463 7 tube amplifiers containing 3Z7F7, 1-7Y4, 3-7N7, 4 potentiometers, numerous resistors, filter and bypass condensers, filter chokes, power and audio transformers, and six sensitive plate relays. A military development that provided amazing stepless control proportional to correction required for alterations, rudder and elevator, in the original application. A control amplifier of the ordinary type would deflect the rudder by some arbitrary amount when the ship was blown off the course to port or starboard. The result would be either be that the correction was insufficient and the plane continued off course, or the correction would be too great, starting a series of tackings and would greatly increase fuel consumption and elapsed time in reaching the objective. This phenomenal unit, with its 3 amplifiers and six 5000 ohm relays in bridge circuits, will accurately control any 3 operations, related or unrelated, in minutely adjustable uniquely quantitative variations in either forward or reverse directions. 9"x7"x8" black crackle aluminum case. Brand new in original carton. \$9.95.

Aluminum gear box 18x8x7 that contains two powerful electric motors and two matched gear trains. 62 gears in all varying in size from 1/2 to 4 inches in diameter. This unit is readily converted to rotate a beam antenna or any other similar use.....\$3.00

BRAND NEW INVERTERS AND DYNAMOTORS

- PE 6A: A 24 to 32 V DC input, to 80 V. AC regulated output converter\$12.95
 - PE 19A: A 24 to 28 V DC input, to 80 V AC at 800 cps output\$9.95
 - (We include a stepup transformer with each of the above so that 110 V AC is available from either.)
 - 27 V DC input 285 V DC @ 75 MA output98c
 - 27 V DC input. Output 300 V @ 150 MA, 150 V @ 15 MA and 12 V @ 5 Amp.\$5.95
 - 12 V DC input. Output 300 V @ 150 MA, 150 V @ 15 MA and 12 V @ 5 Amp.\$12.00
 - 13 or 26 V DC input. Output 800 V DC, 400 V DC @ 135 MA, and 9 V AC\$15.00
- (By running on 6 V AC, 60 cycle input, with a small amount of DC for field excitation, the above dynamotor will provide a good source of 12, 24, 400 or 800 V DC.)

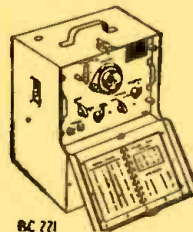

BC-221 FREQUENCY METERS with calibrating Crystal and calibration charts. A precision frequency standard that is useful for innumerable applications for laboratory technician, service man, amateur, and experimenter at the give away price of only \$36.95.

GENERAL ELECTRIC 150 WATT TRANSMITTER

Cost the Government \$1800.00
Cost to you \$44.50!!!!



This is the famous transmitter used in U.S. Army bombers and ground stations, during the war. Its design and construction have been proved in service, under all kinds of conditions, all over the world. The entire frequency range is covered by means of plug-in tuning units which are included. Each tuning unit

has its own oscillator and power amplifier coils and condensers, and antenna tuning circuits—all designed to operate at top efficiency within its particular frequency range. Transmitter and accessories are finished in black crackle, and the milliammeter, voltmeter, and RF ammeter are mounted on the front panel. Here are the specifications: FREQUENCY RANGE: 200 to 500 KC and 1500 to 12,500 KC. (Will operate on 10 and 20 meter band with slight modification). OSCILLATOR: Self-excited, thermo compensated, and hand calibrated. POWER AMPLIFIER: Neutralized class "C" stage, using 211 tube, and equipped with antenna coupling circuit which matches practically any length antenna. MODULATOR: Class "B"—uses two 211 tubes. POWER SUPPLY: Supplied complete with dynamotor which furnishes 1000V at 350 MA. Complete instructions are furnished to operate set from 110V AC. SIZE: 21 1/2 x 23 x 9 1/4 inches. Total shipping weight 200 lbs., complete with all tubes, dynamotor power supply, five tuning units, antenna tuning unit and the essential plugs. These units have been removed from unused aircraft but are guaranteed to be in perfect condition.

- MODULATION TRANSFORMERS—10 watt, metal case 98c; 30 watt, open-type, \$1.95; 40 watt, cast aluminum case, \$2.95; Class "B" input transformers, cast aluminum case, \$1.95; Transceiver audio transformers, 65c; Transceiver modulation transformers, 65c.
- MINIATURE PLIERS SET contains one of each of the following: Needles nose, flat nose, parrot nose, standard nose. All contained in a leatherette case. Your cost—\$1.98.
- SOCKET WRENCH SET consisting of 5 sockets ranging in size from 5/16 to 1/2" and a handle—79c.
- AUTOMATIC WIRE STRIPPERS will strip up to 1000 wires per hour, a handy tool for any service job—\$3.52.

GENERAL ELECTRIC RT-1248 15-TUBE TRANSMITTER-RECEIVER

TERRIFIC POWER—(20 watts) on any two instantly selected, easily pre-adjusted frequencies from 435 to 500 Mc. Transmitter uses 5 tubes including a Western Electric 316 A as final. Receiver uses 10 tubes including 955's, as first detector and oscillator, and 3-7H7's as IF's, with a slug-tuned 40 Mc. IF transformer, plus a 7HT, 7BE's and 7E7's. In addition unit contains 3 relays designed to operate any sort of external equipment when actuated by a received signal from a similar set elsewhere. Originally designed for 12 volt operation, power supply is not included, as it is a cinch for any amateur to connect this unit for 110V AC, using any supply capable of 400V DC at 135 MA. The ideal unit for use in mobile or stationary service in the Citizen's Radio Telephone Band where no license is necessary. Instructions and diagrams supplied for running the RT-1248 transmitter on either code or voice in AM or FM transmission or reception, for use as a mobile public address system, as on 80 to 110 Mc. FM broadcast receiver, as a Facsimile transmitter or receiver, as an amateur television transmitter or receiver, for remote control relay hookups, for Geiger-Mueller counter applications. It sells for only \$29.95 or two for \$53.90. If desired for marine or mobile use, the dynamotor which will work on either 12 or 24V DC and supply all power for the set is only \$15.00 additional.

PE-109 32-Volt DIRECT CURRENT POWER PLANT

This power plant consists of a gasoline engine that is direct coupled to a 2000 watt 32 volt DC generator. This unit is ideal for use in locations that are not serviced by commercial power or to run many of the surplus items that require 24-32V DC for operation. The price of this power plant is only \$58.95. We can also supply a converter that will supply 110v AC from the above unit or from any 16-32V DC source for \$12.95. Due to the fact that the PE-109 comes to us sealed in a heavy steel-strapped govt. case, it is impossible to inspect the individual units to determine if they are new or used, or what the condition is if used. Consequently we must sell them "as is." In general they represent a terrific bargain.

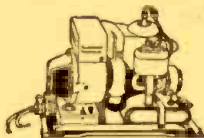

TERRIFIC VALUE—PORTABLE ELECTRIC DRILL

(Sold at less than established factory price so we cannot mention brand name) Only \$19.95 equipped with 1/2" Jacobs Geared Chuck and Key. Not an intermittent duty drill, but a full size rugged tool. Most convenient type switch, natural grip handle, and balance like a six shooter. Precision cut gears—turbine type cooling blower—extra long brushes. No stalling under heaviest pressure because of powerful 110 Volt AC-DC motor and multiple ball thrust bearing. Other bearings self-aligning lifetime-lubricated Chrysler Oilite type. Made for toughest year-in and year-out service in plant or on construction jobs. Amazing perpetual factory guarantee assures you of a lifetime of trouble-free use. 25% deposit on C.O.D.'s. Full refund (you pay transportation) if not pleased with drill after trial.

SCR-274N COMMAND SET

The greatest radio equipment value in history

A mountain of valuable equipment that includes 3 receivers covering 190 to 550 KC; 5 to 6 MC; and 6 to 9.1 MC. These receivers use plug-in coils, and consequently can be changed to any frequencies desired without conversion. Also included are two Tuning Control Boxes; 1 Antenna Coupling Box; four 28 V. Dynamotors (easily converted to 110 V. operation); two 40-Watt Transmitters including crystals, and Preamplifier and Modulator. 29 tubes supplied in all. Only a limited quantity available, so get your order in fast. Removed from unused aircraft and in guaranteed electrical condition. A super value at \$29.95, including crank type tuning knobs for receivers. Without these knobs the receivers can't be tuned, and are only useful for parts. Don't buy without knobs! We also include one 60 cycle, 110 to 24V filament transformer for receiver—FREE.

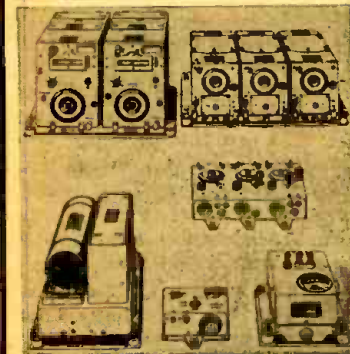

Minimum order \$3.00—All prices subject to change—25% deposit with C.O.D. orders

SENSATIONAL SCOOP—Brand new 1948 model 7 1/2 H.P. twin cylinder outboard motor made by the world's second largest manufacturer of outboard motors. Regular price everywhere \$169.95. Our amazing price on this hard-to-get item at the peak of the seasonal demand is \$142.95, or \$135.00 each in lots of three or more.

UNIVERSAL MICROPHONE CO.'s latest model recorder microphone with high quality recording amplifier complete with all necessary controls for volume, tone, playback, record, and public address applications. Unit features crystal playback and magnetic recorder head attached by special pantographic arrangement for making absolutely linear recordings. Complete with all tubes and matched speaker. Everything supplied but the cabinet for \$46.95

- TUBES—All types in stock. 60% off on all tubes if ordered in lots of 10 or more.
- TRANSFORMERS—All types in stock. AUTO-TRANSFORMERS: Steps up 110v. or steps down 220v to 110v—\$1.95. FIL. TRANS.: 6.3v. 20 Amps.—\$1.98; Universal Output Trans. 8 Watt—89c; 18 Watt—\$1.29; 30 Watt—\$1.69. AUDIO TRANSFORMERS: S. Plate to S. Grid. 3:1—79c; S. Plate to P.P. Grids—79c; Heavy Duty Class AB or B. P.P. Inputs—\$1.49; Midget Output for AC-DC sets—69c; MIKE TRANSFORMER for T-17 Shure microphone, similar to UTC omcncr type—\$2.00; Stancor SB or DB mike to line or grid—\$1.95.

MIDGET BASIC 1 WATT RIG supplied complete with polystyrene coil forms for 3 ham bands. Size over all 3" x 1" x 2 1/4" high. Includes practically all necessary parts. Details on page 62 of January 1948 QST. Your cost \$1.50.

Cable Address: BUFRAD

BUFFALO RADIO SUPPLY, 219-221 Genesee St., Dept. 6 C. BUFFALO 3, N. Y.

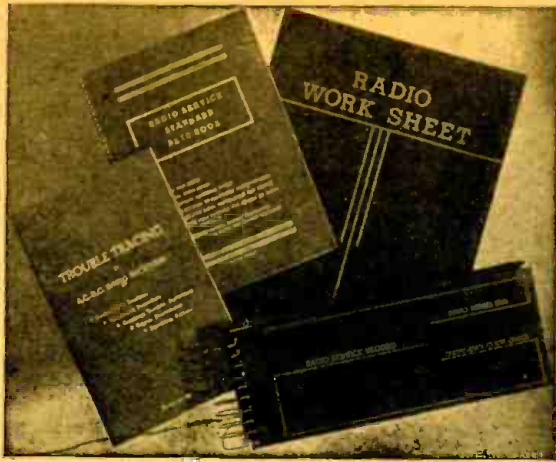

VALUABLE SERVICE AIDS!

- A. TROUBLE TRACING**—for checking all AC-DC Radio Receivers.
- B. RADIO SERVICE STANDARD RATE BOOK**—gives pricing on all radio repairs.
- C. RADIO WORK SHEET**—complete details of the service job.
- D. RADIO SERVICE RECORD**—handy form of 100 numbered service job tickets.

A. "TROUBLE TRACING IN AC-DC RECEIVERS"

50 pages packed with essential servicing data in AC-DC sets. Each part thoroughly analyzed, causes, effects and remedies discussed in detail. Fifty case histories with their logical solutions. Easy to understand, technical verbiage held to a minimum. Equivalent to 5 years practical experience **\$1.00**

B. "RADIO SERVICE STANDARD RATE BOOK"

The standard of fair dealing. Contains complete details for turning out a clean repair job at a fair price. Divided into six sections covering each general type of set. Registry of electronic manufacturers and thorough coverage of crystal cartridges with photos of 51 different types. Spiral bound, edge indexed, attractive green enamel cover **\$1.00**

C. "RADIO WORK SHEET"

Don't hide your light under a bushel. Use the WORK SHEET to acquaint your customer with the complete details of his repair job. Shows 38 minor repairs and adjustments in handy check-off listing. Everything shown. No hidden charges **60c** per 50 sheet pad

D. "RADIO SERVICE RECORD"

Book of 100 numbered service job tickets in 3 part form. Designed for practical service use. Series available—1001-1100, 1101-1200, 1201-1300, 1301-1400, 1401-1500, 1501-1600, 1601-1700, 1701-1800, 1801-1900, 1901-2000. Space provided for dealer rubber stamp **\$1.25 ea.**

AT PARTS DISTRIBUTORS EVERYWHERE

Write for catalog sheet

OELRICH PUBLICATIONS, 4135 N. Lawler Ave., Chicago 41, Ill.

FIDELOTUNER

FOR MAXIMUM F-M LISTENING PLEASURE!

Edwards



CONVERTS ANY RADIO RECEIVER or SOUND AMPLIFIER for F-M

Featuring Revolutionary NEW Tuning Device

New and revolutionary tuning principle* makes EDWARDS FIDELOTUNER most efficient F-M CONVERTER on the market today! All the great advantages of F-M reception are yours, with this compact, efficient new tuner. Five tubes, plus selenium rectifier.

Edwards Fidelotuner, in cabinet, as shown, ready for your F-M Listening Pleasure, size 11" long, 6" wide, 6 3/4" high.

List Price **\$38.50**

(Slightly higher West of Rockies)
DISTRIBUTORS! Some territories still open.
We invite inquiries. Write for literature.

Manufactured by

EDWARDS F-M RADIO CORP.
168 Washington Street New York 6, N.Y.

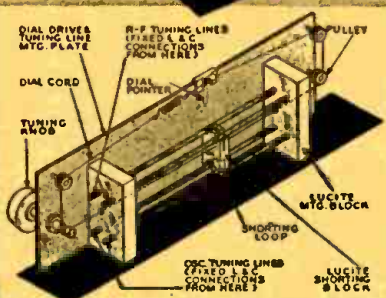

As illustrated in "FM Transmission and Reception" by Rider and Utter. Published by John P. Rider, Publisher, Inc.

FM RECEIVER SERVICING TECHNIQUE

(Continued from page 31)

balanced (Fig. 5) connect the vacuum-tube voltmeter between point B and ground. The procedure is the same as for the Foster-Seeley discriminator.

For the unbalanced ratio detector (Fig. 6), connect two 68,000-ohm resistors in series across R1 and the common lead of the vacuum-tube voltmeter to point C. Connect the other lead to point B. The rest of the alignment is the same as for the balanced ratio detector.

Limiters, i.f. amplifiers

When a receiver becomes noisy, check the limiter stage. Limiters become noisy when their grid-leak circuits open or voltages rise above normal. Under these conditions it will require considerably stronger signal voltages to saturate the tube, and the limiting action is impaired.

A check of the i.f. system is made quickly. Connect the vacuum-tube voltmeter across the limiter grid-leak resistor. Connect the output lead of the AM signal generator to the control grid of the first i.f. stage, and the ground lead to the receiver chassis. Set the signal generator to the i.f. center frequency. The vacuum-tube voltmeter needle will deflect when the i.f. system is functioning. If the signal path is broken, move the generator toward the limiter to reveal the defective stage.

Sets with ratio detectors usually have no limiters. In these instances, place the v.t.v.m. at point A in Fig. 5 or 6. The indications will be the same as with the meter in the limiter grid circuit.

To align the i.f. amplifiers, connect the vertical input terminals of an oscilloscope across the grid-leak resistor in the limiter stage and the sweep signal generator between the converter (or mixer) tube control grid and ground.



Fig. 8—Marker signals identify frequencies.

Adjust the signal generator for a 100-ke sweep about the i.f. mid-frequency. A curve as in Fig. 9 will be obtained if the system is aligned.

When the receiver contains a ratio detector, connect the oscilloscope between point A on Fig. 5 or 6 and ground.

The i.f. stages can be aligned with an AM signal generator. The process requires considerably more time because most i.f. transformers are overcoupled.

To peak an overcoupled transformer, load the primary with a 1,000-ohm resistor, and adjust the secondary trimmer for maximum response. Then switch the loading circuit to the secondary winding, and adjust the primary for maximum response. This is done for each set of i.f. transformer windings.

The AM signal generator feeds its signal into the grid of the tube preceding the stage containing the transformer under adjustment. Connect the indicating voltmeter in the limiter grid circuit at point A in ratio detectors. With a sweep generator, we observe the full response at once, and artificial loading is unnecessary.

In testing the r.f. section of FM receivers, it is best to start at the oscillator. The oscillator is the most critical stage in the front end and most likely to be at fault. Measure the voltage between the control grid and cathode of the oscillator with a v.t.v.m. to determine whether or not it is functioning. The voltage may have any value between -2 and -10. Too low a value may be due to a bad tube or low operating voltage. If the plate and screen voltages are correct, change the tube. Measure the grid voltage on all bands since the tube may not function at some frequencies. This may be due to defective switching or to the fact that a tube oscillates more at low frequencies.

If the oscillator is operating satisfactorily, connect the AM signal generator to the receiver input terminals. Tune the receiver and the signal generator to the same frequency. Place the vacuum-tube voltmeter in the grid circuit of the limiter or at point A of the ratio detector. If the set is operating satisfactorily, the meter will be deflected. If there is no response, change mixer or converter tubes, measure voltages at the electrodes, and make resistance checks.

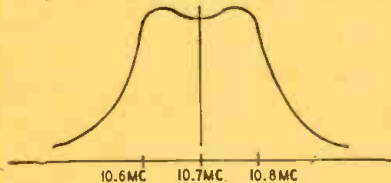

Fig. 9—Response curve of an FM i.f. system.

The serviceman must not rearrange any of the components on the underside of the chassis, especially small coils. It is impossible to emphasize too strongly the criticalness of these high-frequency circuits. Many of them, especially the oscillator, contain compensating condensers to compensate for changes in the electrical characteristics of the tuning condensers and the coils. If one of these condensers becomes defective, the circuit is detuned. The serviceman might conclude that the circuits merely require alignment and readjust them. However, it will drift during each warm-up period, and the drift may be sufficient to shift the r.f. circuits out of range of the signal. The set will have to be retuned each time it is turned on.

Another frequently encountered defect is a howl caused by the speaker vibrating the oscillator tuning slug. Place a fiber spacer between the oscillator and the mixer slug shafts to eliminate the vibration. This effect may become noticeable only as the volume control is advanced, but the remedy is the same. Howling may also be due to speaker vibrations reaching the oscillator sections of the gang condenser. Mount the gang condenser on a rubber cushion or a felt strip to stop this howl.



Free

NEW COMPLETE *Concord*

RADIO CATALOG

160 VALUE-PACKED PAGES

23 pgs. Radio and Television Sets • 62 pgs. Radio Parts
18 pgs. Sound Amplifiers and Accessories • 23 pgs. Ham Gear
9 pgs. Electronic Test Equipment

Mail COUPON TODAY!

CONCORD RADIO CORPORATION, Dept. 146
901 W. Jackson Blvd., Chicago, 7, Ill.
Yes, rush FREE COPY of the comprehensive new Concord Radio Catalog. (Please Print)

Name:

Address:

City & Zone: State:

CONCORD

RADIO CORPORATION

CHICAGO 7 ATLANTA 3
901 W. Jackson Blvd. 765 Peachtree St.
Downtown Chicago Branch: 229 W. Madison
Leotone Radio Corp.

WIRE & TAPE RECORDING COMPONENTS

Essential "hard-to-get" basic parts for constructing units described in "Radio News," Feb., '48

WIRE RECORD-PLAYBACK HEAD. Precision built Triple-Coil (recording, playback, erase) 4 pin plug-in type. Moulded bakelite housing (1 1/2" x 1 1/2") accurately "V" grooved for maximum fidelity & sensitivity. For replacement or new applications. 6.95

WIRE SPOOL HUB. Polished aluminum. Takes standard wire spool (1 1/2" hole). 1/4" shaft hole. 3/4" deep. .39
PERMALLOY OUNCER LAMINATIONS. Hydrogen annealed. Specifically for use in constructing TAPE RECORD-PLAYBACK HEADS. Per ounce contg. laminations 40
MAGNET WIRE—Sufficient to wind complete TAPE HEAD. 22 P.E.—35c
#30 SCC—45c

RM-4 RECORDING MOTOR. Heavy duty. 110V. 60 cycles. Adaptable to WIRE, TAPE or DISC RECORD & PLAYBACK. 5/16" O.D. shaft. 3 3/4" sq. 2 1/2" deep. Loss turntable, mkt. plate & reduction drive wheel. Shpg. wt. 6 lbs. \$4.95

ALNICO ERASE MAGNET for TAPE OR WIRE. "U" shape; polished poles. 1/2" x 1/2" x 3/16" gap 39
Send for latest illustrated ALNICO MAGNET supplement.

STOP! LOOK!—ORDER NOW

LEOTONE'S VALUE-PACKED "SUPER" RADIO PARTS ASSORTMENT. This is your chance to stock up on new & dismantled quality radio & electronic parts—17 FULL POUNDS of COILS, TRANSFORMERS, SUB-ASSEMBLIES, SPEAKER ACCESSORIES, WIRE, SOCKETS, etc., etc. All these AND MORE for only \$2.95

CO-AXIAL CONNECTORS 83-ISP (PL-259) or 83-IAP right angle adaptor. Each 29c. 4 for \$1.00
4" PRECISION ETCHED DIAL. Calibrated 0-100 over 180°. Plated brass. 1/2" hole, setscrew 39
JK-24 JACK. Circuit opening, long frame. Takes standard 2 way phone plug. 2 1/2" long. Ea. 23
10 for 1.98

SENSITIVE D.P.D.T. RELAYS. Famous make. 3/16" silvered contacts with protective plastic housing. 18-28V DC. 160 ohm coil. 1 1/2" x 1 1/2" x 1 1/2". BRAND NEW—ONLY 39c. 15 for \$5.00

250 OHM LINE TRANSFORMER to 8 ohms. 5 equal taps, 0 to 16db. Excellent low-loss matching to 1 or more remote speakers. Diagram incl. 69c. 2 for 1.25

HANDY RADIO PARTS KITS

- #1—R.F., ANTENNA & OSC. COILS. 10 asstd. .98
- #2—MOULDED BAKELITE CONDENSERS. 50 asstd. 00001 to 2 mfd. 200-600VV. Clearly marked. 2.95
- #4—TUBULAR BY-PASS CONDENSERS. 50 asst. .001-to .2 mfd. 200-600VV. Standard brands. 2.49
- #9—WAFER SOCKETS. 12 asstd. 4 to 7 prong. .25
- #10—VOLTAGE DIVIDERS. 10 asstd. multi-tapped. High wattages included. 1.98
- #12—MICA PADDERS & TRIMMERS. 15 asstd. incl. multiPlo & ceramic base.69
- #27 ± 1% Wire Wound. Std. Makes. 1W. 10 asstd. 1.98
- #28—ROTARY SELECTOR SWITCHES. 6 asst. standard makes. Multi-deck & ceramic input 1.75

TUBES! TUBES! TUBES!

All in perfect condition, but in unsealed cartons. Most types in stock at up to 80% off list. Every tube guaranteed 90 days.

#20, 27 or 31 29
#24, 42, 75, 77, 78, 6M6 or 6K7 39
#37, 39, 5Y4, 5U4, 6A4, 6A7, 6A8, 6B7, 6C5, 6F5, 6J5, 6J7, 6L7, 6SA7, 6SF5 or 12SK7 49
#1A7, 1N5, 6U5, 6X5, 7A7, 7Y4, 50 or 50B5 59

TUBE CARTONS, Plain. Miniature (1" sq. x 2 1/4") Per 100 98
GT size (1 1/2" sq. x 3 1/4") Per 100 1.25
Medium (1 3/4" sq. x 4 1/4") Per 100 1.49
Large (2" sq. x 5") Per 100 1.79

"LAMINOID" TRANS-LUCENT PANELS, 1/16" x 3 3/4" sq. Red with gray backing for decorative or insulating purposes .35 ea.

Get on our mailing list—always something new. A Better Cone—Buy Leotone PROMPT SERVICE ON ALL SPEAKER & PHONO PICK-UP REPAIRS. Min. Order \$2.00—20% deposit req. on COD's

LEOTONE RADIO CO.
MAKERS OF CONES AND FIELD COILS
65-67 DEV STREET, NEW YORK 7, N.Y.
WORTH 2-0284-5
12,000 SQ. FT. OF RADIO PARTS

Almo presents...

TELEVISION
ASSEMBLY CO.



The Dumont Inputuner tunes continuously from 44 to 216 megacycles without a break, covers all 13 channels as well as FM, amateur, and aviation channels. For ease and convenience of operation no band switching of any kind is required when tuning from channel to channel with the inputuner system. Just one simple operation to reach any desired station.

Complete Line of TELEVISION ASSEMBLY'S Champion Models WITH DUMONT INPUTUNER



10" Champion model
273.10

12" Champion model
303.10

15" Champion model
393.10

Standard Models

All Television Assemblies are complete and include: 29 RCA Tubes—plus CR Tube—Heavy Duty RCA 6.8 oz. slug 12" PM Speaker—Specially designed dipole antenna with 60 ft. lead in.

10" Standard model 12" Standard model 15" Standard model
229.50 259.50 349.50

25% DEPOSIT—
BALANCE
C. O. D.

Superior performance is obtained with a new IF Video & Sound IF Strip (Pat. Pend.) aligned, wired, pretuned, tubed and tested. All circuits are contained on one chassis ready to use with the front end unit supplied. This front end will handle 13 channels and is aligned and tested, mounted on a separate chassis. Merely connect B plus filament and output IF leads to the television chassis. It is not necessary to make any RF alignments. These units utilize a clipper circuit which filters out ignition noises.



Almo RADIO COMPANY

509 ARCH ST. PHILADELPHIA 6, PENNA.

FM SWEEP GENERATORS (Continued from page 25)

a 'scope for optimum alignment of all FM and AM receivers and tuners. FM receivers must be properly aligned to take advantage of the high-fidelity and noise-free characteristics of the Armstrong and ratio-detector circuits.

The following is a list of features incorporated in different types of FM-AM signal generators, with a description of each type. The cross index lists popular makes of FM-AM signal generators and the features each includes, as well as their relative prices. Experience indicates that wide-band television sweeps combined with such instruments are impractical and prohibitively expensive. A separate restricted-range r.f. generator with 10-mc sweep has proved more satisfactory.

FREQUENCY RANGE: Continuous coverage from 100 kc to at least 110 mc is essential to cover all services. All frequencies should be fundamental—not harmonics.

NUMBER OF BANDS: More bands mean better dial accuracy. However, an excessive number of bands is time consuming.

FM DEVIATION RANGE: Must be at least ± 150 kc wide to permit visual analysis of wide-band FM receivers. An additional narrow deviation range permits accurate alignment of i.f. stages of high-fidelity AM receivers. Calibrated variable deviation is a valuable feature since it enables direct reading of i.f. band width which indicates fidelity response. For example, if the i.f. signal is fed into the converter, the discriminator

pattern may be viewed on the 'scope and measured directly in kilocycles on the deviation scale of the generator.

FM SWEEP FREQUENCY: Ability to vary the deviation rate is useful. It permits a point-to-point oscilloscope check through the whole set from speaker to antenna with one setting of the signal generator.

OUTPUT CALIBRATION: It is almost impossible to design a signal generator whose output voltage doesn't drop as the frequency is increased. Response curves therefore have little meaning unless the output level can be corrected with frequency. In addition, a calibrated direct-reading meter can indicate the signal-to-noise ratio, sensitivity, and gain per stage. This is a quick way to find a defective tube or circuit.

AMPLITUDE MODULATION: A variable audio oscillator included means an additional instrument at the same price. It can be used externally to test audio response, speaker and cabinet resonance.

VARIABLE MODULATION PERCENTAGE: Standard feature—should be included but not critical as to percentage of variation permitted.

OSCILLOSCOPE SYNCHRONIZATION: Unless a 'scope is synchronized, it will be impossible to get a stationary pattern. Clip leads can be used to pick up external synchronizing voltages but are inconvenient and apt to introduce phase distortion.

OSCILLOSCOPE PHASING: A phasing control eliminates a double image on the 'scope. Phasing can be adjusted with a potentiometer and condenser hung on the horizontal input terminal, but the usual objection to haywire applies.

ACCURACY: Usual standards prevail. Should be weighed against the type of pointer and scale, since ability to read calibration is equally important. Optimum arrangement would be highest accuracy obtainable plus a large dial, preferably protected and having a knife-edge pointer.

DIAL TYPE: Protected dials retain calibration better than unprotected ones. A large dial and thin pointer permit more accurate reading of calibration.

ADVANTAGES OF FM

(Continued from page 27)

tually obtained. The correlation between the two is good. In general, field measurements have shown that FM stations are obtaining coverages very close to what has been predicted.

Fig. 3 illustrates the approximate ranges of various classes of FM stations. There is considerable variation due to local conditions, but they are roughly as follows:

- | Radius
in miles | |
|--------------------|---|
| 13.5 | —Class A station, 1 kw effective radiated power, antenna height 250 feet, in Area I with the maximum permissible interference under FCC standards. |
| 32.0 | —Class B station, 20 kw effective radiated power, antenna height 500 feet, in Area I with the maximum permissible interference under FCC standards. |

- 38.0—Class A station with no interference such as would be the case for all but the most densely populated sections of Areas I and II, power and height as above.
- 65.0—Class B station in Area II, power and height as above.
- 102—Class B station in Area II designed for rural coverage, effective radiated power 160 kw, antenna height 1580 feet above average terrain. (Radio KRNT, under construction at Des Moines, Iowa.)

Today, there are more than 500 FM stations on the air, and the FCC has authorized the construction of over a thousand FM stations to date.

The existing 400 stations provide primary service to an area in which 60 million people live, and it is expected that 1,000 FM stations will be on the air by the end of 1948. These stations will serve 117 million people—84% of the population of the United States.

The FCC should crack down on persons or companies who have secured construction permits for FM broadcast stations but have failed to erect a station, says the FM Association. A resolution to that effect urges that the FCC be asked to "investigate carefully" all applications for extension of time where construction permit holders have not put their stations on the air within the time specified.

RADIO QUIZ

By HAROLD GLENN

Check your radio knowledge. Any question may have more than one correct answer and, in at least one case all answers are correct.

1. Mercury-vapor rectifiers are used for their (a) low voltage drop, (b) high peak inverse voltage, (c) heavy current handling.
2. The condenser-input filter is good for (a) light loads, (b) low output voltages, (c) heavy loads.
3. A swinging choke is used to (a) vary the bias, (b) improve voltage regulation, (c) handle more current.
4. Condenser-input filter circuits require insulation protection for voltages (a) equal to d.c. output plus a.c. input, (b) 1.41 x d.c. output, (c) 1.41 x a.c. input.
5. The most common method of coupling r.f. stages together is (a) resistance, (b) transformer, (c) capacitance.
6. Capacitance within a tube is between (a) plate and grid, (b) plate and cathode, (c) grid and cathode.
7. The deflector plates in beam-power tubes take the place of (a) control grid, (b) suppressor grid, (c) plate.
8. A supercontrol radio amplifier has the least amplification when (a) the grid is most positive, (b) the plate is at the saturation point, (c) the grid is most negative.
9. Selectivity in a receiver means (a) louder signals, (b) sharper tuning, (c) grid bias.
10. The output transformer has (a) high primary resistance, (b) step-up turns ratio, (c) low secondary resistance. (See page 82 for answers)

Get All 10

ONLY 50c EACH
\$5.00 SET OF 10

These Books Keep You On Your Toes!

Here are a total of 640 pages of downright practical knowledge to help you keep punching away at the unknown factors of radio until you have mastered them. Every one of the 10 is worth many times its 50c price if you will just apply a small portion of the information gained to your daily work. You'll be glad you have the complete set handy whenever you are trying to work out a particular problem in construction, testing or servicing. You'll like the easy-to-read type—the clean-cut printing—the smart, modern, flexible covers, and the great number of illustrations. They all help to make learning a pleasure. Order as many as you need today—better still, make it all 10.



No. 29—HANDY KINKS AND SHORT CUTS. A carefully edited compilation of time savers, Kinks on Antennas—Power Supplies—Test Equipment—Servicing—In the Shop—Phonographs and Amplifiers—Coils and Transformers—Miscellaneous.

No. 30—UNUSUAL PATENTED CIRCUITS. 1944-1946. A gold mine in new hook-ups! A selection of unusual circuits, many a result of wartime research—of great value to anyone interested in electronics. Control Circuits—Detectors and Amplifiers—Power Supplies—Miscellaneous Circuits—Foreign Circuits.

No. 31—RADIO QUESTIONS AND ANSWERS. Answers to most frequently asked questions. Clear schematics. Amplifiers—Receivers—Transmitters—Meters and Test Equipment—Interphones—Power Supplies—Phono Amplifiers—P. A. Systems.

No. 32—ADVANCED SERVICE TECHNIQUE. An up-to-date collection of information for the advanced serviceman: Visual Alignment—Tracking Problems—Negative Feedback—Tone Control Circuits—Adding Microphones to Sets—Matching Loudspeakers—Remote Juke Boxes—Servicing Record Changers—Hum Elimination—FM Servicing.

No. 33—AMPLIFIER BUILDER'S GUIDE. Invaluable for the designer and builder of audio equipment. Tells how to build a wide variety of amplifiers. Detailed design information on: Push-Pull—Phase Inversion—Bass and Treble Boosters—Volume Expanders—Resistance Coupling—Internal Feedback.

No. 34—RADIO-ELECTRONIC CIRCUITS. An extensive collection of circuit diagrams, with brief, to-the-point descriptions of each, including: Intercommunications Systems—Power Supplies—Balancing Circuits—V.T. Voltmeters—Amplifiers—Receivers—Phono Amplifiers—Short Wave Adaptors—Electronic Relays.

No. 35—AMATEUR RADIO BUILDER'S GUIDE. For the "ham" who builds his own. Practical, down-to-earth. Tells you how to build: A 2 Meter Band Acorn Tube Set—Miniature Communications Receivers—Long Lines Transmitter—Beginner's Transmitter—Preselector—Rotary Beam Aerial—Power Supplies, etc.

No. 36—RADIO TEST INSTRUMENTS. A MUST for every radio man. This latest book on building test equipment places emphasis on practical construction of: Signal Tracers—Capacity Meters—Portable and Bench Multi-checker—Signal Generators—Tube Checkers—Electronic Voltmeters—and many others.

No. 37—ELEMENTARY RADIO SERVICING. For the radio man who knows little about servicing. How to get started, and even more important, how to keep going: Planning the Service Shop—Equipping the Shop—Systematic Circuit Checks—Signal Tracing Methods—Servicing the Midset—Soldering—Servicing Volume Controls—How to Service Speakers.

No. 38—HOW TO BUILD RADIO RECEIVERS. This book contains a sufficient variety of sets to appeal to every radio fan. Includes: Short-Wave, Broadcast, Portable, A.C. Operated, Miniature and Standard Receivers. Complete coil-winding data.



RADIO-CRAFT LIBRARY SERIES

RADCRAFT PUBLICATIONS, Dept. 68
25 West Broadway, New York 7, N. Y.

See Your Radio Dealer
If He Can't Supply You, Use Coupon

Send me the volumes (50c each, postpaid) checked. My radio dealer is All 10 Books **\$5.00**
unable to supply.

I enclose \$..... 29 34
 30 35
Your Name (Print Clearly) 31 36
Address 32 37
Dealer's Name 33 38
Address

Our 26th Year

NATIONAL COMPANY COMPONENTS

Direct Calibration Dials—5:1 Drive Ratio
 ACN—7 1/4" W x 5" H.....\$3.00
 ICN—7 1/4" W x 5" H with illuminated scale \$6.00
 SCN—6 1/4" W x 4 7/16" H.....\$3.00
 MCN—8 1/4" W x 2 1/4" H.....\$2.70
 NPWO Gear Drive 20:1 Ratio; Shaft perpendicular to Panel with Micrometer Dial.....\$7.20
 PWO Gear Drive 20:1 Ratio; Shaft Parallel to Panel with Micrometer Dial.....\$9.00
WE CARRY A COMPLETE LINE OF NATIONAL PARTS & RECEIVERS

APC-25mmf Silver Plated Air Trimmer.....15c
 10 for.....\$1.25
 APC-50mmf Silver Plated Air Trimmer.....15c
 10 for.....\$1.25

OIL FILLED CONDENSERS

1 Mfd., 750 VDC, Sprague.....15c
 7 Mfd., 350VAC, G.E.....98c
 10 Mfd., 330VAC, G.E.....\$1.25
 10 Mfd., 600VDC, Capacitron.....98c
 16 Mfd., 400VDC, W.E. Co.....98c
 2 Mfd., 1000VDC, Aerovox.....69c
 0.1 Mfd., 7500VDC, G.E.....\$1.50
 2 x 0.1 Mfd., 7000VDC, G.E.....\$2.00
 1 Mfd., 5000VDC, Solar.....\$2.95
 2 Mfd., 10000VDC, C.D.....\$13.95

WIRE

No. 10 Copper Enamel 100 Ft. Lengths Each.....\$1.75
 No. 12 Copper Enamel 100 Ft. Lengths Each.....\$1.25
 No. 14 Copper Enamel 100 Ft. Lengths Each.....93c
 300 ohm Twin Lead Plastic covered, 100 ft.....\$1.95
 72 ohm Co-Ax Cable 7c per Ft., 100 ft.....\$6.75
 3 Conductor Rubber Covered Cable per Ft.....3c

CS—DIFFERENTIAL RELAY—S.P.D.T.



Dual Coil with Armature Pivoted between coils. All contacts normally open operates 220-250 volts. 8000 ohms each coil contacts Rated 2 amps @ 110VAC. Ideally suited for balanced or bridge type circuits where limited current or power is available. For only... **95c**

G.E. 2500 Ohm Relay—S.P.D.T., 4MA D.C., 5 prong plug in type, hermetically sealed. Brand New..... **95c**



ITEMS YOU MAY BE LOOKING FOR

Federal type Selenium Rectifiers, 100 Ma., each.....50c
 Do Jur W. W. 20,000 Ohm Pot. 12 watt.....49c
 ARC-5 Banana Plugs silver plated, per dozen.....10c
 PL-259 Coaxial Plugs Silver Plated, 19c Ea., per 100.....\$15.00
 150 Watt, 5 ohm. W. W. Rheostat 4" Diameter \$1.95

CARDWELL VARIABLE CONDENSERS

ET-27-AD: 27mmf split stator 15 plates per section .070 Air Gap Isolanlite Insulation 1/4" Shaft.....\$1.29
 ER-35-AD: 35mmf split stator 11 plates per section. .030 Air Gap Isolanlite Insulation 1/4" Shaft.....\$1.05
 MP-26 GS: 26 mmf 7 plate .070 Air Gap Mycalex Insulation 1/4" Shaft.....\$1.29
 NUV-150VS: 150mmf 35 plate. .070 Air Gap Mycalex Insulation 1/4" Shaft.....\$1.95
 ZO-50-AS: 50mmf-21 plate. .030 Air Gap Isolanlite Insulation, Screw Driver Adj.....95c

METERS

5-0-5 Amps. D.C., Charge and Discharge Scale 2" Round.....69c
 0-1 Amp. RF, G.E. 2" Round.....\$2.45
 100 Amp—6 volt D.C. 3" Scale, 1/4" Square, Gray finish with shunt. A Swell Buy.....\$2.95
 0-100 MA 2" RD.....\$1.95

TUBES At Real Prices

5BP1, CR Tube 5" Green Screen, New.....\$1.45
 832A, Dual Beam Power Tetrode, New.....\$2.15
 6J6, Twin Triode Miniature, New.....50c
 3C24, Triode, 100 Watt Power Output, New, ea.....39c
 10 for.....\$3.50

If not rated 25% with order, balance C.O.D. All prices F.O.B. our warehouse New York. No order under \$2.00. We ship to any part of the globe

LEEDS RADIO CO.

75 Vesey Street Dept. RC6
 Cortlandt 7-2612 New York City 7

Quality - Price - Dependability



ATTENTION !!

ALL SCR-522 OWNERS
 Remote Control Boxes for SCR 522's. Brand New in Original Packaging: Consists of 5 push button switches, 5 Weston Electric Pilot Assemblies, with Pilot Bulbs and Dimmer, and lever Switch all finished in Black Crackle. Order yours Today for only **\$1.25 ea.**
 Antenna Plug 46-PS-1 for 522A.....15c ea.

STEEL CHASSIS	
7 x 7 x 2.....63c	10 x 14 x 3.....\$1.35
7 x 9 x 2.....73c	8 x 17 x 3.....90c
7 x 11 x 2.....90c	7 x 17 x 3.....\$1.26
7 x 13 x 2.....96c	8 x 17 x 3.....\$1.22
5 x 10 x 3.....87c	11 x 17 x 3.....\$1.66
6 x 14 x 3.....93c	13 x 17 x 3.....\$2.22
	All Black Wrinkle Finish
Steel Cans and Boxes	
4 x 4 x 2.....68c	8 x 10 x 10.....\$2.06
4 x 5 x 3.....78c	12 x 7 x 8.....\$1.68
5 x 6 x 9.....\$1.04	11 x 12 x 8.....\$2.25
6 x 6 x 6.....98c	15 x 9 x 7.....\$2.35

Sloping Front Meter Case, Cut for 3 inch Meter. Size 4 1/2 x 4 x 4.....92c
 All Black Wrinkle Finish

Dynamotor-5047-D.C. Input 27 volts @ 1.75 amps. Output 285 volts @ 0.75 amps. continuous duty **95c** Rating, Brand New.
 DM-43A Dynamotor, Manufactured by G.E. New. Input 24v @ 23 Amps. 7500 RPM; output 515/1030/2'8v. @ 215/260 milliamps; filtered, Special..... **\$2.95**

Selenium Rectifier Full Wave 68 VAC Input 48VDC Output .5 Amp.....\$1.50

WIRE WOUND POTENTIOMETER

100,000 ohm, precision made. G. R. type, 25 watt, 6" diameter. **\$1.95**
 Brand new.....



Heinemann Circuit Breakers. 5 amp. sizes..... **95c**

117 VOLTS ON AUTO RADIO

Auto radios may be tested by the power supply without the use of a storage battery. A 6X5 rectifier tube and a 6.3-volt filament transformer are used to supply B-plus voltage to the set.

In operation, the rectifier tube and vibrator are removed from the receiver under test. The cathode of the 6X5 is connected to the input of the d.c. filter in the receiver. The positive battery lead and a lead from the chassis are connected directly to the transformer secondary with the two short leads shown. This provides filament voltage for the tubes. This will, of course, be an a.c. voltage; since auto sets are designed for d.c. filament voltage, the test supply may introduce some hum, but for checking purposes this will usually not be important.

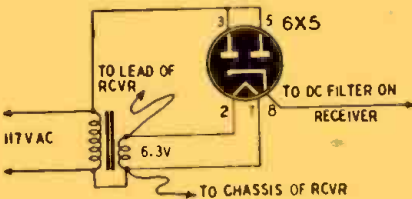

Test the vibrator before removing it, by attaching the two 6-volt a.c. leads to the filament—or battery—leads of the radio. If the vibrator purrs, it is probably O.K. If not, the trouble may be in it.

A. P. NIELSON,
 Seattle, Wash.



Philip Rand started a new trend to real, badly-needed receiver-selectivity with his Q-5er. Byron Goodman carried it forward with his "Lazy-Man's Q-5er". We applaud both steps, but felt that even more could be attained by special design to really give every ham super-het, new or old, the "New Look" selectivity QST advocates.

Our answer is Model 805, 100kc. I.F. Amplifier. Connect it between your last i.f. secondary and your audio volume control and you get a small boost in gain. But what you really get is single-side-band selectivity — a selectivity curve 2.4kc. wide across the flat top, skirts falling so steeply as to be only 4.7kc. broad 1000 times (60 db.) down, only 7.2kc. wide 10,000 times down! As Byron Goodman says of this new look selectivity, it will "cut thru the QRM and pull out the desired signal like nothing you ever saw or heard". Take Model 805, only 3 7/8" wide, 4 15/16" long, 5 5/8" high, make 6 simple connections to your 455/465 kc. i.f. receiver, (which can usually supply 6.3 V. ac. at .75 Amps. and 110 to 250 volts d.c. at 25 ma. to the 805) and you have that post-war receiver with the "new look"

Model 805 Price, less 1 - 6 BE6, 1 - 6 BA6, 1 - 6C4 tubes, only \$18.90*
 Model 805K — kit complete less tubes, \$15.90*

*Prices slightly higher West of Rockies.

Send for Catalog

See these and other McMurdo Silver LCETI instruments at your favorite jobber.

OVER 37 YEARS OF RADIO ENGINEERING ACHIEVEMENT

McMurdo Silver Co., Inc.

EXECUTIVE OFFICES: 1240 MAIN ST., HARTFORD 3, CONN.
 FACTORY OFFICE: 1249 MAIN ST., HARTFORD 3, CONN.

30,000

RADIO SERVICE-TECHNICIANS READ



EVERY MONTH

RADIO MAINTENANCE today fills a breach that has existed in the radio field for a long time. Already 30,000 servicemen read RADIO MAINTENANCE every month because it is devoted entirely to the Radio Service Technician.

The RADIO MAINTENANCE staff specializes in the preparation of articles on every phase of Radio Maintenance in series form which may be filed and used for reference. The leading articles cover everything for the radio serviceman on Television, FM and AM; Test Equipment; Electronic Appliances; Tools; Antennas; Alignment; Troubleshooting; Repair; Construction; Pick-ups and Sound Amplification and Reproduction Equipment. Also, in RADIO MAINTENANCE each month there are departments on hints and kinks, the latest news of the trade, review of trade literature, radiomen's opinions, new products and news from the organizations. All articles are presented in a step-by-step precision style, clearly illustrated, with schematics, accurate photographs, specially prepared drawings, white on black charts, color diagrams, isometric projections and exploded views.

RADIO MAINTENANCE is not sold on newsstands

Binders in beautiful green simulated leather stamped in gold are now available for your RADIO MAINTENANCE magazines — see the current issue of RADIO MAINTENANCE for information.

RADIO MAINTENANCE MAGAZINE RC6
440 Bloomfield Avenue,
Montclair 5, N. J.

Please send me RADIO MAINTENANCE for
 1 year at \$3.00 Bill me later
 2 years at \$5.00 Payment enclosed

Name
 Address
 City—State
 *Occupation
 Title
 Employed by

*Independent Serviceman — Dealer Serviceman—
 Service Manager—Dealer—Distributor—Jobber.

BOLAND & BOYCE INC., PUBLISHERS

HIGH-VOLTAGE REGULATION

George C. Sziklai and Robert R. Thaler, Princeton, N. J.
 (Assigned to Radio Corp. of America)
 Patent No. 2,435,414

Many high-voltage supplies for television are now derived from sweep circuits. Saw-tooth pulses are amplified and rectified to produce the d.c. Unfortunately, regulation is not too good with this method. This patented invention uses a pentode instead of a diode for the rectifier. Good regulation is obtained because the plate-current characteristic of a pentode is a horizontal line when control and screen grid voltages are constant.

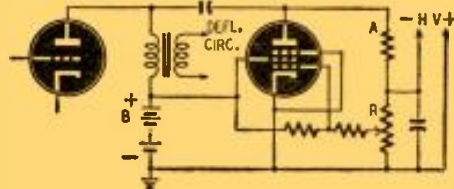

The triode shown is the saw-tooth voltage amplifier. The high-voltage pulses appear between plate and cathode of the pentode, and rectified current flows through the filter A to the output terminals. The screen grid voltage is kept constant because it comes from the d.c. plate supply, as shown. The control grid bias is derived from the voltage drop across R. Two d.c. currents flow in opposite directions through R. One is supplied by the B-power supply; the other is rectified current from the pentode. The grid bias may be adjusted originally at the potentiometer.

The output voltage tends to fluctuate with changing loads and potentials. When it rises, the pentode grid becomes more negative, causing plate current to drop. When reduced, it causes higher plate current. Therefore the output voltage is compensated.

QUARTZ CRYSTAL SUBSTITUTE

Robert Adler, Chicago, Ill.
 (Assigned to Zenith Radio Corp.)
 Patent No. 2,435,487

Quartz crystals are important in many types of communication circuits. However, the raw material is not abundant and must be carefully chosen to avoid even minute flaws. In addition it is difficult to cut to the required shape and size, thus adding to the cost of the finished crystal. The mechanical substitute for a quartz crystal described here is suitable for use at frequencies from about 250 kc to 3 mc.

The principle of operation is shown in A. A coil or loop and a washer-shaped metal disc are placed in a magnetic field. The loop is supplied with current from an external source and induces a secondary current in the washer. Arrows show the directions of these currents at a particular instant. The washer current is accompanied by its own magnetic field.

The reaction of both fields on the washer causes it to vibrate, as shown by the four arrows. When the loop current reverses, so does the force on the washer. Actually, the loop is supplied from a high-frequency source and the washer element vibrates at the same rate. There is some frequency at which maximum vibrations are obtained, depending upon dimensions of the washer.

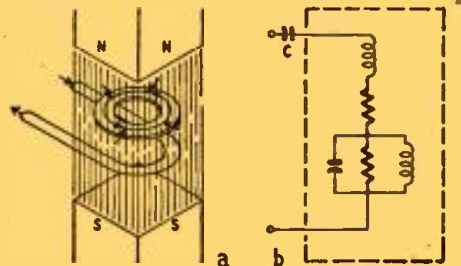

Because of the mutual reaction between the loop circuit and the vibrating element, a high value of impedance is reflected into the loop circuit. The entire mechanical unit is equivalent to the electrical network at B. There is a parallel-resonant circuit in series with a resistor and an inductance. The inductance may be resonated with an external capacitance C to produce a series-

resonant circuit tuned slightly off that of the parallel circuit. This gives a maximum change of impedance between the two frequencies.

As an example of size, a 1-mc vibrator has the following dimensions; outer and inner diameters are respectively .267 and .25 inch, and thickness .01 inch. The material may be aluminum or molybdenum, and the Q is higher than 5,000. The magnetic field has a strength of about 10,000 gauss.

REMOTE OPERATION OF MOTORS

Richard G. Clapp, Haverford, Pa.
 (Assigned to Philco Corp.)
 Patent No. 2,435,423

Suitable for driving small clocks or other motors by microwave power transmitted from a distance, this system is especially useful for operating small synchronous motors which may require an accurately controlled frequency but which are not located near a 60-cycle line.

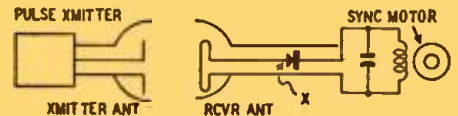

A magnetron or other pulse-type transmitter, operated directly from the a.c. line, radiates 60 pulses of high-frequency power per second. These pulses are picked up, detected by a crystal X, and shock-excite a resonant circuit tuned to 60 cycles. The nearly sinusoidal oscillations are amplified and can be used to operate a clock or other motor.

IMPROVED PENTODE TUBE

Robert Adler, Chicago, Ill., and John G. Prentiss, Berwyn, Ill.
 (Assigned to Zenith Radio Corp.)
 Patent No. 2,426,681

This new type of pentode makes possible very high amplification in a single tube. The area of the plate is smaller than that of the third grid. This grid is also closely wound. The remaining elements are roughly similar to those in the usual pentode tube.

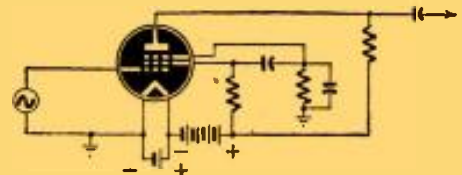

With this construction the third grid can control the plate current, becoming a control grid. In addition it controls the screen current. This is because the total cathode current remains approximately constant for a given control grid potential. Therefore any plate current variation is accompanied by a corresponding and opposite variation of screen current.

The new tube may be connected as shown in the schematic. The screen circuit contains a load across which amplified voltage is developed. This voltage is transferred to the third grid which controls plate current. The output voltage exists across the plate load. In effect this tube is connected as two triodes in cascade.

There is also a regenerative effect in the new tube. As described previously, a more negative third grid reduces plate current and therefore increases screen current. This reduces the screen voltage. Since the screen potential is coupled to the third grid through the condenser, the original potential of the third grid is intensified. With suitable design regeneration is present without sustained oscillations.

An output of several volts may be obtained when the input is in the order of millivolts.

CIRCULAR SWEEP CONTROL

Alden Packard, Kanmore, N. Y.
 (Assigned to Colonial Radio Corp.)
 Patent No. 2,436,447

This invention may be used with a circular sweep oscilloscope in radar detection and for measurements of rotating machinery. In a radar installation, for example, a saw-tooth current flows through deflecting coils and causes the

electron beam to move at a constant rate away from the center of the screen and then to be returned abruptly. The deflecting coils rotate continuously around the 'scope tube so that the radial path of the beam also rotates and scans the entire surface. A bright spot on the pattern shows the location of an object within the field of the transmitter.

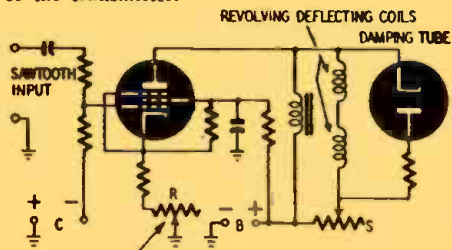

VARIABLE FOR SIMULTANEOUS CONTROL OF AMPLITUDE AND ZERO POSITION OF BEAM

To expand the pattern on the screen for closer study requires that the saw-tooth current be increased. The deflection current is actually composed of two parts: the amplified saw-tooth current and the average or static plate current. If only the first component is increased (by greater amplification), the beam will travel out further but will also be returned to a point beyond the center of the pattern. This is because the center point of the radial path is determined by the average or static plate current which has not been changed.

In the circuit shown, resistor R controls negative feedback and tube amplification. At the same time it adjusts the average value of grid bias. The resistors in the cathode and screen-grid circuit and resistor S are determined by experiment. Design is correct when the d.c. plate current changes in the same ratio as the amplification, when R is varied.

THYRATRON REGULATOR

Donald R. Gibbons, Belmar

and Harry L. Chaney, Red Bank, N. J.

(May be used by the U. S. Government without royalty payment)

Patent No. 2,435,961

A thyatron may be used as a regulator tube for very high currents. The regulator circuit is shown in the figure. An upper transformer winding has an R-C network to displace the thyatron grid voltage compared to the plate voltage. The lower winding supplies high voltage to the thyatron plate and the plate of a tetrode through a diode rectifier. The tetrode voltages are stabilized by VR tubes.

Rectified output from the thyatron is filtered and appears at the output terminals. Some of this voltage is fed to the screen-grid of the tetrode through an adjustable resistor S. If the output voltage should drop, the screen grid becomes less positive and less current flows through T. The thyatron grid potential becomes more positive than before, and the tube conducts earlier each cycle to compensate for the reduction in output voltage.

The advantages of the thyatron in this circuit are low voltage drop and high current-carrying capacity. In addition the control is gradual, a characteristic usually associated only with vacuum tubes.

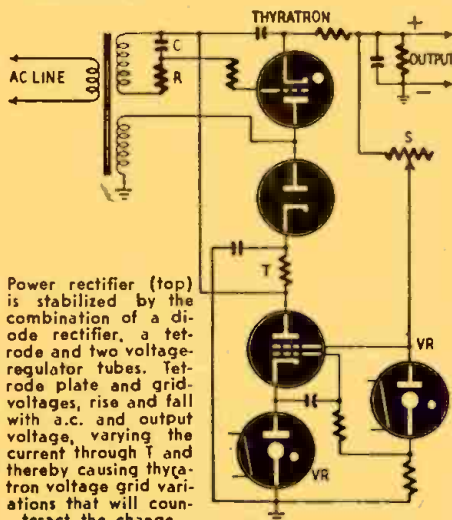

Power rectifier (top) is stabilized by the combination of a diode rectifier, a tetrode and two voltage-regulator tubes. Tetrode plate and grid voltages, rise and fall with a.c. and output voltage, varying the current through T and thereby causing thyatron voltage grid variations that will counteract the change.



from this NEW, IMPROVED

LEAR MAGNETIC PHONO PICK-UP

HIGH FIDELITY

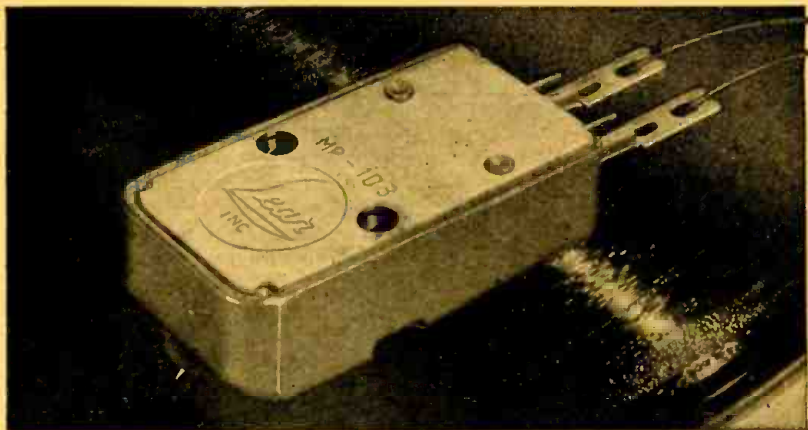

\$ Profit and Exquisite Record Reproduction...

JOBBERS ... SERVICEMEN ... turn service calls into profitable sales with ease. This new LEAR Reluctance Pick-Up transforms "flat" old-fashioned sound into full-toned modern reproduction!

This new, improved High-Fidelity Reluctance Pick-Up is LEAR engineered to excel in quality of performance . . . and priced for your profit. Replaces millions of old style crystal pick-ups now in use! Jewel stylus eliminates needle changing — holds surface noise to a bare minimum. It performs a miracle of modernization — assures full tonal beauty of sound wherever installed.

List this "hot" seller in your catalog! Service men who feature the new LEAR Magnetic Pick-up will pick up extra profits every day! Cash-in now—write for complete discount price list today!

To complete your LEAR Sound Service: New, Improved LEAR PRE-AMPLIFIER, List Price—\$9.90

To provide additional amplification with use of MP-103 LEAR Magnetic Pick-up. Can be connected directly to old crystal cartridge input. High voltage and filament wires provided for connection into existing equipment. Two-position switch permits high-fidelity response to finest quality recordings.

No. PA-103 (not shown here)—LEAR Tone Arm Assembly with MP-103 Magnetic Variable Reluctance Pick-Up Cartridge, List Price \$15.50.

Designed for high-fidelity reproduction of 10" and 12" recordings. Spring counter-balance provides "feather touch" operation—only 17 grams stylus pressure on record. This reduces record wear to a minimum. Handsomely finished in brown metallic.

Factory Representatives—Distributors: A few choice territories are still available for these and other fine LEAR Electronic Products. Write today giving full details.

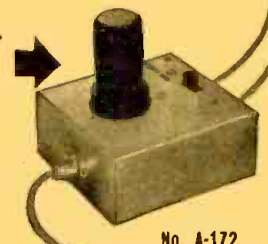

No. A-172



110 Ionla Ave. N. W. Grand Rapids 2, Mich.

LOOP ANTENNA

? I would like to have a diagram of a highly directional loop antenna for use on the broadcast band. The response should be maximum in one direction instead of front and back as in the usual type.—E.V.P., Ordnance, Ore.

A. Here are circuits of two directional loop antennas. In circuit A, the loop is used as a sensing antenna as well as a directional loop. For best unidirectional effect, throw S1 to "balance" and adjust C until the signal has equal intensity each side of null position. After the loop is balanced, throw S1 to "sense" and rotate the loop for maximum signal.

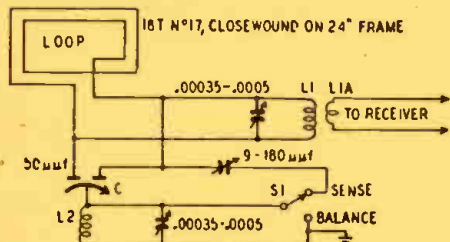

Ckt. A—Simple direction finding loop input.

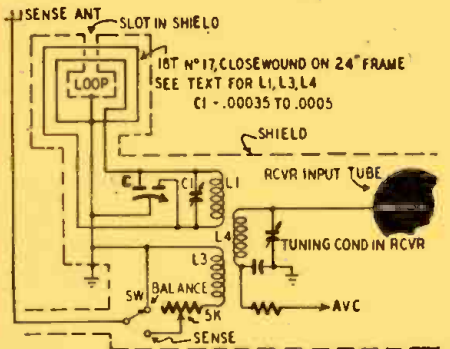

Ckt. B—An improved direction-finder circuit.

Circuit B is similar, except that the 5,000-ohm potentiometer is adjusted for best phase conditions. It has the advantage that the loop is shielded and the length of the vertical antenna, which must be used in this circuit, can be adjusted for optimum signal strength. The signal from the vertical antenna through the potentiometer and L2 should be equal to, but not greater than, the signal from the loop.

The parts list for both units is:

- L1—Approximately 1 millihenry. Can be winding from i.f. transformer.
- L1A—Wound to match receiver input.
- L2—Approximately 240 microhenries. Can be secondary of standard r.f. coil with turns added or removed.
- L3—250 to 500 microhenries, closely coupled to L1.
- L4—Inductance to match other tuned coils in receiver. Loosely coupled to L1 or coupled for best signal transfer.
- C—Differential-type variable capacitor, approximately 50- μ f. Cardwell type ER-50-AB may be used.

ELECTRONIC STETHOSCOPE

? I am a physician and my hearing is impaired to the extent that I have trouble hearing heart sounds (35 to 60 c.p.s.) with an acoustic stethoscope. I want to build an electronic instrument using a lapel-type crystal microphone

and a small battery-powered amplifier. I wish to attenuate all frequencies above 100 c.p.s. when desirable.—N.A.R., Pittsburgh, Pa.

A. The amplifier in the diagram will give sufficient gain and output under normal conditions. Should greater gain be needed, a CK510AX could be substituted for the first CK512AX with a 25% increase in A-battery drain. If less power output is permissible, a CK522-AX could be used in place of the CK506-AX.

RECORDING AMPLIFIER

? Please print a diagram of a recording amplifier using a 6SJ7, 6SQ7, and a 6L6. I want to use a 10-ma d.c. meter for indicating recording levels if possible. The recording head is the 4-ohm magnetic type.—S.K., Honolulu, T.H.

A. Input circuits for a microphone and a playback pickup are provided in this recording amplifier. Monitor phones can be used when recording. The recording level meter is used with a full-wave 10- or 15-ma meter rectifier. Shield grid and plate leads to the 6SN7 input.

MULTIMETER

? I have a 200-microampere d.c. meter with a 600-ohm internal resistance. I would like to use this as the basis for a multimeter with a.c. and d.c. voltage ranges to 1,000 volts, d.c. to 1 ampere. The meter has a resistance scale calibrated up to 2,000 ohms. I would like to use this and have additional scales to read up to 2 megohms.—K.L.L., Bloomington, Ind.

A. This multimeter circuit should meet your needs. All parts values are shown. The accuracy of the meter will depend on the accuracy of the shunts and multipliers. The 150-ohm resistor across the output of the a.c. rectifier should be adjusted to draw 1 ma. The 1,400-ohm resistor in the direct current line may be made variable to compensate for any inaccuracies in measuring the internal resistance of the meter.

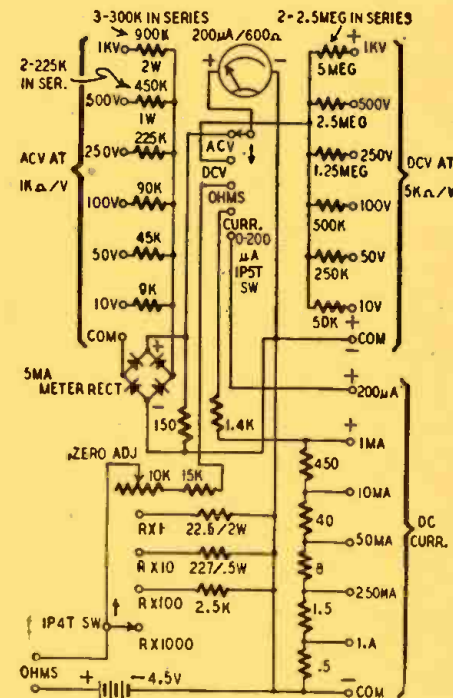

Multimeter with a 200-microampere movement.

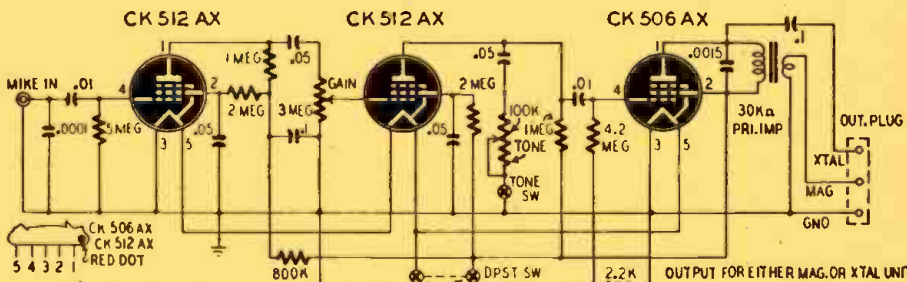

An electronic stethoscope which uses three of the subminiature hearing-aid type tubes.

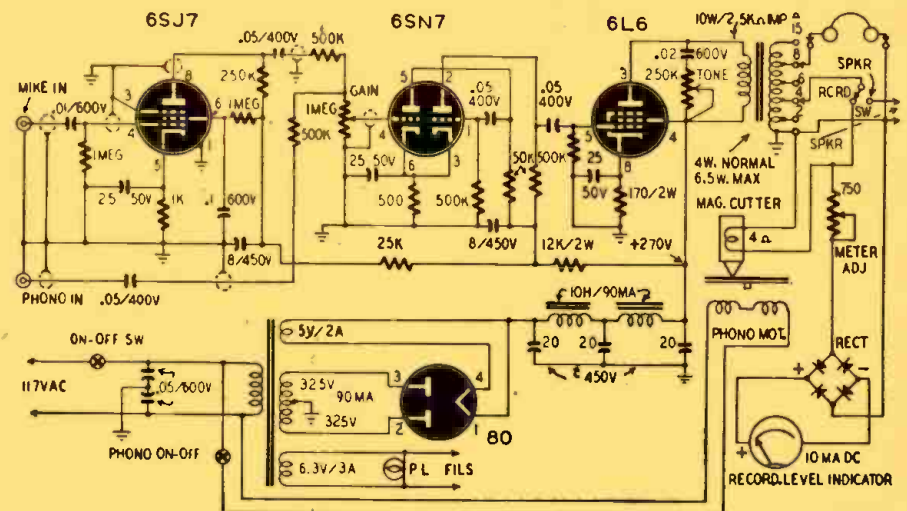

This medium-power recording amplifier uses a 10-milliamperere meter as level indicator.

BASS-COMPENSATION

A small iron-cored coil in the voice-coil leads of a speaker provides a very effective form of bass compensation. The inductive reactance of the coil increases with the frequency, thus decreasing voice-coil current at high frequencies while passing lower notes.

P. C. DIMITZACOPOULOS,
St. Johns, P. Q., Canada

(The inductance may consist of a small filter choke, iron-cored r.f. choke, or other inductance having values between 100 mh and 5 henries. Experiment with different values for best results.—*Editor*)

SPEAKER CLEANING KINK

To remove bits of iron or steel from between the pole and voice coil of a loudspeaker, insert a screwdriver into a coil of insulated wire and energize the coil with d.c. to make a powerful electromagnet. Keeping it in the magnetic field, run the end of the screw-driver all around the space between the pole and the voice coil while moving the cone back and forth. This will remove magnetic material.

E. S. COLEMAN,
Dallas, Texas

PICKUP ARM MOUNT

Here is a quick way to substitute phono pickups on a record player.

Remove the hinge at the end of the pickup arm and replace it with a phone plug. Mount a phone jack in the base of the pickup arm swivel. The exact mounting varies with the different types of arms.

To change pickups, merely remove one and plug in another.

ALBERT THOMAS, JR.
Cleveland, Ohio

CLEANING RADIOS

I attach a rubber hose to the outlet of a vacuum cleaner and use the air blast to blow out the dust from cabinets, speakers, chassis, and other sections of radios. This is more effective than using a cloth or a brush.

The air blast also removes many scratching and hissing noises that cannot be found easily.

FLOYD STORY,
Springfield, Ill.

HIDDEN ANTENNA

Many modern homes have metal-lined laundry chutes running from the upper floors to the basement. These make excellent antennas. The lead-in can be soldered to the metal lining and brought into the room through a hole drilled into the side of the chute close to the wall of the room. In most cases, the lead-in can be concealed by running it along the baseboard molding, or possibly under a carpet.

A preliminary check should be made with an ohmmeter to make sure the chute is not grounded.

HOWARD A. MILLER W2WL2
Rochester, N. Y.

NOW COLLINS introduces... THE "Super 20" TUBE FM RECEIVER

Unexcelled in Performance • Remarkably Low in Cost

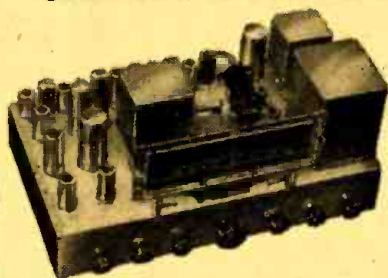

Write Today for Complete Details

Designed to satisfy the most critical professional or amateur, the Collins "Super 20" offers unsurpassed value in an FM RECEIVER. The advanced 20-Tube circuit features: Armstrong FM, built-in stabilized power supply and audio amplifier capable of 10-watt output; new 6AL7GT tuning eye, connections for 2 types of phono pick-up, output impedances to match 4 to 20 ohm voice coils and 500 ohm fine, and variable bass and treble tone controls with attenuation and boost for upper and lower registers.

COLLINS Audio Products Co., Inc.
P. O. BOX 368 • WESTFIELD, N. J. • WE. 2-4390

SHURE T17B
Push Button Carbon Mike
88¢
With Cord and Plug

ASTATIC MIKE
Here's a HOT value for YOU! High quality crystal mike. Can be used either as hand mike or desk mike. With Stand, Base and 7 ft. Cable. **\$6.95**

TURNER MIKE
High quality crystal hand-mike, unidirectional, wide range response. One-piece construction, 2 3/4" diam. by 1 1/2" thick. Complete with attached 100-ft shielded mike cable. A truly wonderful buy, for only **\$5.75**

GENERAL INDUSTRIES HOME RECORDING UNIT
VALUE \$39.95
\$19.95
A low priced recording and play-back unit to cut records up to 10 & 12 inch records. Consists of 10" turntable, cutting head, and crystal pickup on a base plate 15" wide and 10" from front to back.

DETROLA AUTOMATIC RECORD CHANGER
Plays 10 & 12 inch records automatically. Crystal pickup. Special **\$14.49**

2 TUBE PHONO OSCILLATOR
Complete with tubes, 35Z5, 12SK7. Use with record player, and tune in on any radio. Complete. All Wired. **\$4.75**

WEBSTER RECORD CHANGERS
Model #156 Plays 12-Ten or 10-Twelve inch records. AUTOMATIC STOP • CRYSTAL PICKUP Reg. \$42.70—**\$25.95**
Model #156-27—Same as above with G.E. Reluctance pickup and pre-amplifier \$7 extra.
8 section telescopic aerial\$1.95
100 Asst. Resistors, IRC, etc.\$1.79

3 Tube PHONO AMPLIFIER Volume and tone control. ALL WIRED with Tubes. **\$4.95**
ASTATIC Pick Up with G.I. motor **\$4.95**

25% Deposit, Bal. C.O.D. Plus Charges
Write for Latest Catalog
BONAFIDE RADIO CO.
89 1/2 Cortlandt St., Dept. K, N.Y. 7, N.Y.

RADIO PANEL LABELS

Commercial-looking letters for your radio can be easily made. The materials needed are: clear speaker cement, an indelible pencil, and a small slab of smooth unglazed porcelain about 2 x 2 x 1/4 inches.

Print the letters on the porcelain slab with the pencil. Then apply a thin coating of cement to the letters with a soft brush, allowing it to dry for about 1/2 hour. After it has dried, peel off the cement, trim the edges, and glue it to the equipment with transparent glue, such as Duco cement.

STANLEY J. ZUCHORA,
Detroit, Mich.

COMPARE THESE VALUES

NATIONALLY KNOWN BRANDS INDIVIDUALLY BOXED	
0Z4	.88
1T4	.88
1R5	.88
1S5	.88
3S4	.88
3Q4	.88
5Y3GT	.42
6X5GT	.59
6K6GT	.59
6V6GT	.69
25Z6GT	.59
25L6GT	.69
12AT6	.59
12BA6	.69
12BE6	.69
12SA7	.69
12SK7	.69
12SQ7	.59
35B5	.69
35L6GT	.69
35W4	.49
35Z5GT	.49
50B5	.69
50L6GT	.69

DEDUCT 10% IN LOTS OF 50 OR MORE
Write for Free Illustrated Bargain Bulletin
JOYCE RADIO DISTRIBUTING
BOX 2068 HOLLYWOOD 28, CALIF

Report From Britain

By Major Ralph W. Hallows

RADIO-CRAFT EUROPEAN CORRESPONDENT



SOMETIME ago I wrote that it was strange that there should be so little interest in television in France.

By that I meant interest amongst televisioners and potential televisioners; for French technicians are most actively concerned with this branch of radio. What must be one of the most advanced

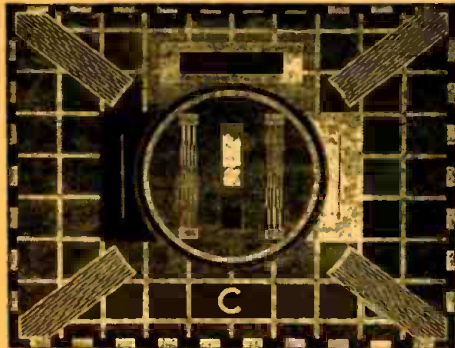

Fig. 1—BBC's new television test pattern.

outfits in the world—if, not *the* most advanced—is the French mobile demonstration equipment, which has been making a tour of Switzerland, Belgium, Holland and Scandinavia. The system has an 819-line scan coupled with a transmitted band-width of 10 mc.

The outfit is housed in a small fleet of trucks. One of these contains the 50-watt 200-mc transmitter. The same

truck contains the mixer, which allows either of the two cameras carried to be faded in or out as required. Each camera has a battery of lenses of different focal lengths in a turret. When either of the turrets is being rotated, its camera is automatically cut out and the other automatically cut in, to avoid all chance of one particularly annoying effect. The apparatus must be amazingly robust, for its journeys were made in winter time. I know the countries visited—and their roads. There is nothing wrong with complicated electronic equipment which can be unpacked, erected, tested and be in full working order within five hours of its arrival at Oslo, Norway.

The images are said to be of as good quality as those of the movies. With an 819-line definition and the 10 mc bandwidth, I can well believe this. I don't know, though, that I'd care to swap jobs with the designer called upon to produce at a popular price, 819-line televisioners able to do justice to a 10-mc transmitted bandwidth!

Keeping them on their toes

I'd like to see what the new French gear would make of the latest test pattern (Fig. 1), transmitted for an hour each morning by the BBC's television system. It was designed jointly by the BBC, and the British television manufacturers to show up almost any fault you can think of in a televiser. The background of the pattern is a mesh of black squares separated by narrow white lines. In the middle is a white circle containing two vertical grids of black and white lines, arranged in blocks corresponding to frequencies of 1.0, 1.5, 2.0, 2.5 and 3.0 mc. The circle also contains a vertical bar, composed of five squares graded in tone values from white through two shades of grey to black. At the corners of the pattern

are line grids corresponding to a frequency of 1.0 mc for checking uniformity of focus over the whole screen. The pattern is completed by a broad black horizontal bar on a white background above the circle and by a narrow white bar on a black ground and a narrow black bar on a white ground, one on each side of it. The scan width of these narrow bars is about 0.25 microsecond.

You can guess what a boon these patterns are, not only to engineers who design televisers, but also to servicemen and to televisioners who know something about the works of their receivers.

The component show

It would have been surprising, if I may so put it, had there been anything new about the show recently held in London by the British Radio Component Manufacturers. We learnt during the war anything that we didn't already know about making compact, robust, fully tropicalised components. Progress then was—and still is—chiefly in the direction of ruggedness, standardization of performance and miniaturization. What one expected was exactly what one did find—a wide range of small, well-made and sturdy bits and pieces, often backed by performance certificates from the National Physical Laboratory, which corresponds in many ways to the American Bureau of Standards. Two points, though, specially impressed me. The first was the ingenious ways in which certain severe shortages in raw materials—steel is one of the most acute—were overcome by the ingenious use of substitutes. Secondly, I welcome the realization by component designers that any separate part of a radio or television receiver should be so constructed that it is easily mounted, connected, and checked, not only in the factory, but also in the serviceman's shop. In the bad old days of the past far too many components seemed to have been designed with a view to making things as difficult as possible for all who had to handle them.

Two highlights

Two of the many good exhibits struck me as being well in the brain-wave class. The first of these is a kit for determining the temperature of soldering iron bits in the quickest and simplest way. Books and articles on soldering have a way of recommending a bit temperature of so many degrees centigrade, but don't tell how to measure it without a pyrometer, which is a pretty unlikely piece of equipment in the amateur's workshop. The kit consists of a number of cards, each containing a length of special wire which melts at a stated temperature. Simple, as many good things are, but very useful!

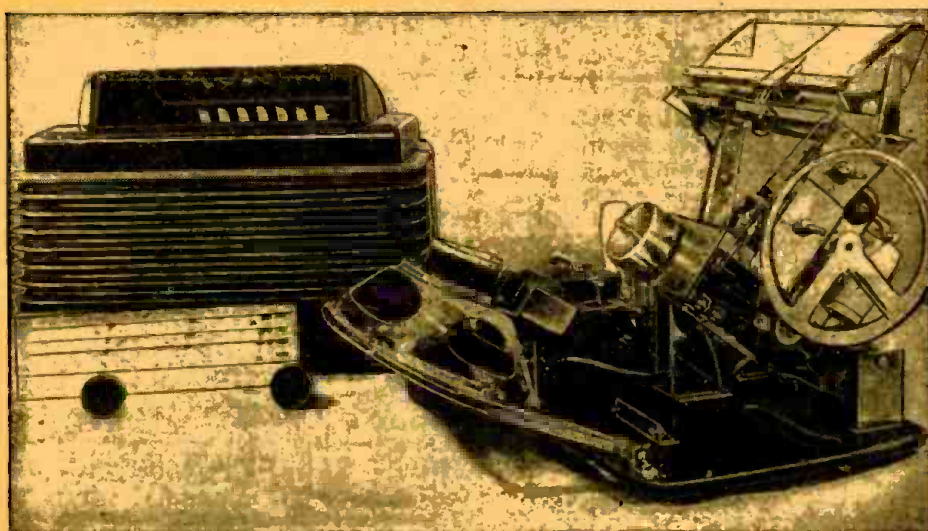

Easily-serviced British radio which 'opens like a flower' on release of a single bolt.

MODERN CRYSTAL RECEIVER

By W. V. NUTALL

A 1N34 germanium crystal diode and parts of a permeability-tuned i.f. transformer are used in this efficient crystal set. It is simple to construct and has good volume and selectivity. Unlike most crystal sets, the primary coil instead of the secondary is tuned. The tuned antenna circuit is an important feature of this receiver because it provides a much greater signal strength at the headphones than if the secondary were tuned.

To construct the receiver, take the i.f. transformer apart and unwind the secondary coil until it is about 70% the size of the primary winding. Remove the iron slug from the secondary core, cut the coil mounting board in two, and mount each part as shown in the drawing. Warm the wax holding the coils

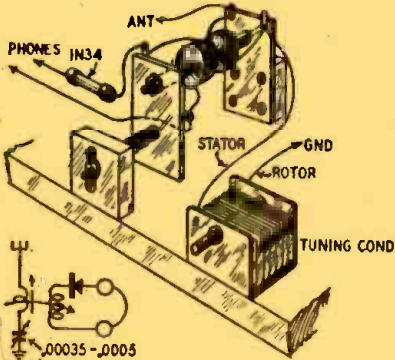
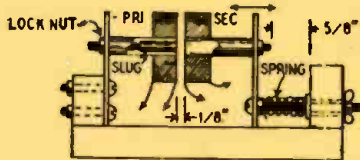

to the forms with the heat from the soldering iron (carefully), and move the coils up flush with the ends of the forms.

The wiring is straightforward. One lead of the 1N34 crystal is soldered to one of the secondary coil terminals and the other lead is fastened directly to the phone jack. Make sure that the rotor of the condenser is connected to ground to prevent detuning due to body capacitance.

Selectivity is determined by the position of the iron slug in the primary circuit and by the coupling between the primary and secondary coils. The secondary coil is moved back and forth, to make this adjustment, by turning the wing nut.

Antenna length is not critical, but it is an important part of the receiver and is worth a little extra effort. Maximum signal strength is obtained along its length, so pointing it toward a more distant station will bring in the station. Placing it at right angles to a strong local transmitter permits weak signals to be heard more clearly. With a 50-foot antenna and with a steam pipe for a ground, at least 10 stations from 200 to 400 miles away have been clearly heard. An average of three more-distant stations are heard four or five nights a week the year round.

JUNE, 1948



Better Products for the Radio Industry

NEW G-C STATIC CHASER INJECTOR and POWDER

Three static powder kits—improve auto radio reception. Eliminates wheel static interference. New powder is blown into all the inner tubes—easy to use. For every car owner!
 No. 5604—Injector for G-C Static Powder.....List \$1.50
 No. 5605—G-C Static Powder Packet for 5 tires.....List \$1.00
 No. 5606—Kit—One Powder Packet and Injector.....List \$2.50

NEW G-C MINIATURE TUBE PIN STRAIGHTENER

Every Radio Man needs a tube pin straightener for the new miniature glass tubes. Each man should have 2 or 3—one to carry with him and several fastened to his bench.
 No. 5191.....List \$1.00

NEW G-C TUBE PULLER

Makes it easy to remove or insert miniature tubes... simple to operate. Inserts or extracts tubes where fingers will not reach—into hard-to-reach places. Saves time and money. Ends tube breakage, prevents burnt fingers.



No. 5093—Miniature Puller.....List \$ 1.65
 No. 5093-D Display of 12.....List \$19.80

NEW G-C FIELD CHASSIS

Holds almost any radio chassis in position! Has special reversible hooks for flanged type chassis or, to tilt chassis back if necessary. Made with slide adjustment—takes only 5 seconds to install. No parts to lose—will never wear out. A real convenience for the radio serviceman!
 No. 5207 Chassis.....List \$3.65



Have you seen the new G-C "Speedex" Wire Strippers... write for illustrated literature.

RADIO DIVISION DEPT. D

G-C Products are available at leading distributors. Write for your copy of our new illustrated catalog.

GENERAL CEMENT Mfg. Co., Rockford, Ill., U.S.A.

Manufacturers of over 3,000 products • Sales offices in principal cities

HOW TO GET THE MOST from only BASIC TEST EQUIPMENT

Servicing by Signal Substitution

The Simple, Modern, Dynamic Speed approach to receiver alignment and adjustment problems, FM-AM-TV.

- Nothing complex to learn
- No extra equipment to purchase
- Universal — non-obsolete
- Employs only Basic Test Equipment



S-S-S tells HOW — in simple, direct language.

New 9th edition now off the press. 100 pages of valuable information.

Available from all leading radio parts and equipment distributors or directly from factory at only 40c per copy.

PRECISION APPARATUS COMPANY, Inc. • 92-27 Horace Harding Blvd., Elmhurst 4, N. Y.

PEN-OSCIL-LITE

Extremely convenient test oscillator for all radio servicing; alignment • Small as a pen • Self powered • Range from 700 cycles audio to over 600 megacycles u.h.f. • Output from zero to 125 v. • Low in cost • Used by Signal Corps • Write for information.

GENERAL TEST EQUIPMENT
 38 Argyle Ave. Buffalo 9, N. Y.

TELEVISION RECEIVER—\$1.00

Complete instructions for building your own television receiver. 18 pages—11"x17" of pictures, pictorial diagrams, clarified schematics, 17"x22" complete schematic diagram & chassis layout. Also booklet of alignment instructions, voltage & resistance tables and troubleshooting hints.—All for \$1.00.

CERTIFIED TELEVISION LABORATORIES
 Dept. C, 5507-13th Ave., Brooklyn 19, N. Y.

JUST OPENED!

New FEDERATED Branch ALLENTOWN, PA.

With completely stocked warehouse and showrooms, featuring all standard brands in Radio, Electronic Parts, & Equipment. IF YOU'RE AROUND—DROP IN AND SAY HELLO!

FEDERATED PURCHASER Inc. 1115 Hamilton St. Allentown, Penna.
 PHONE: Allentown 3-7441

RADIO-CRAFT needs more photos of service shops and service benches. We will pay \$6.00 for each 6x8- or 8x10-inch glossy photo accepted. Do not "dress up" your bench, but take a bona-fide photo, preferably with men working.

FM GENERATOR

Radio Corporation of America
Camden, N. J.

Model WR-53A is an FM signal generator providing output on the 88-108-



mc FM band, either modulated or unmodulated. It also generates an FM signal on the 8.3-10.8-mc band for i.f. alignment. The sweep width is variable to suit different requirements for wide-band reception.

The sweep circuit consists essentially of an electron-coupled oscillator modulated by push-pull reactance tubes. A buffer amplifier between the oscillator and output eliminates frequency shift with changing load. Terminals are provided for obtaining deflection voltages for an oscilloscope.

The unit measures 13 1/2 x 9 3/4 x 7 1/2 inches, and weighs 15 pounds.—RADIO-CRAFT

TV-FM RECEIVER

Sightmaster Corp.
New York, N. Y.

The Sightmaster Model 15-C-11 is a 24-tube table-model combination tele-



vision and FM receiver. It uses a 15-inch picture tube arranged for direct viewing. Video amplifier band width is 4.5 mc. The FM receiver section has a ratio detector and tunes from 87 to 109 mc. Two speakers are provided for improved frequency response. The antenna input impedance is 300 ohms.—RADIO-CRAFT

ALIGNMENT TOOLS

Approved Electronic Instrument Corp.

New York, N. Y.

These alignment tools consist of a radiation loop made of 1/4-inch aluminum tubing and an alignment wand with a 6-inch antenna loop at one end of a wooden rod and a rectangular aluminum plate at the other. The radiation loop acts as an antenna for the signal generator and provides loose coupling between the generator and the receiver. The alignment wand is used to check tracking between the r.f. and oscillator stages of a receiver. They are designed to be used with any receiver that has a built-in antenna.

In use, each end of the alignment wand in turn is held between the radiation loop and the receiver antenna. If one end causes the reading of the output meter to increase and the other end causes a decrease, the two stages are not tracking and alignment is



necessary. If both cause the meter reading to decrease, the oscillator and r.f. sections track.—RADIO-CRAFT

HI-FREQUENCY TUNER

Allen B. Dumont Laboratories, Inc.
Passaic, N. J.

Continuously variable frequency coverage from 44 to 216 mc without band switching is provided by the new Type 7047 Inputuner. It is designed for reception of FM, AM, and television in all services within this range, using the Mallory-Ware Inductuner as a tuning unit. The tuning unit comprises three tuned circuits; grounded-grid input, mixer, and oscillator. Over-all gain is approximately 15. i.f. ratio is about 1,000, and image suppression is in the order of 100. Input impedance is 73 ohms.

Three-hole mounting simplifies instal-

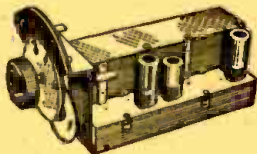

lation in receivers. Dimensions are 7 1/4 x 3 x 3 inches.—RADIO-CRAFT

OSCILLOGRAPH

Hickok Electrical Instrument Co.
Cleveland, Ohio

The Model 505 oscillograph is designed primarily for FM servicing. It uses the new 5U1P 5-inch cathode-ray tube, and contains such features as a wide- and narrow-band FM signal generator with provisions for modulating it from an external source such as a microphone or phono pickup. Additional features are a demodulator, for permitting a modulated r.f. signal to be viewed on the screen, and a phone jack to permit any signal to be heard on headphones. There is also a sinusoidal sweep with a phasing control.

This instrument is designed for align-

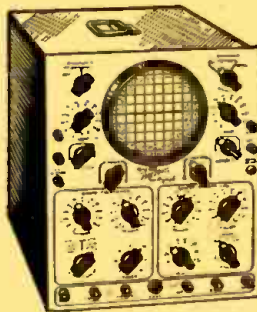

ment of r.f., i.f., and discriminator circuits.—RADIO-CRAFT

ELECTRIC-EYE KIT

De-Tec-Tronic Laboratories, Inc.
Chicago, Illinois

Model AK 115 is a new photoelectric-eye amplifier construction kit offered to

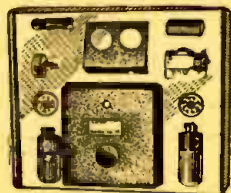

experimenters. The kit contains a phototube, amplifier, drilled chassis, sockets, relay, and all other necessary parts. When completed, the amplifier measures 5 1/2 x 4 1/2 x 2 1/2 inches. It operates on 117 volts a.c. or d.c.—RADIO-CRAFT

MOLDED CAPACITORS

Sprague Electric Co.
North Adams, Mass.

These new phenolic-molded tubular capacitors are usually smaller than ordinary paper capacitors of equal rating. They are heat- and moisture-resistant, nonflammable, and are conservatively rated for operation from -40 to +85 degrees Centigrade.

The capacitors are available in all capacities in 200-, 400-, 600-, 1,000-, and 1,600-volt types.—RADIO-CRAFT

TELE SYNCHRONIZER

Allen B. Dumont Laboratories
Clifton, N. J.

Type 5030 A is a portable television synchronizing generator especially built for field use. It provides mixed driving,



blanking, and synchronizing signals for transmitter testing, television development, and laboratory work.

The master oscillator can be locked to a 60-cycle, 117-volt line, or run free. Half-line driving pulses for differential delay techniques are available for cable hookups.

A regulated power supply and autotransformer make the unit independent of line-voltage variations. Dimensions are 9 1/4 x 17 1/4 x 19 1/2 inches. Weight is about 50 pounds.—RADIO-CRAFT

SWEEP GENERATOR

Clarkstan Corporation
Los Angeles, Calif.

A new type of sweep frequency generator, the Clarkstan Model 125, provides a regularly recurrent changing



pattern for testing audio and electrical equipment.

The complex signal is produced by scanning photoelectrically a synchronously-rotating disc. The modulation on the disc is the photographic reproduction of a precision pattern. Frequency range on 60 cycles is from 40 cycles to 10 kc. Marker pulses are at 1, 3, 5, 7, 9, and 10 kc. Output is 50 mw into a 500-ohm line. Internal impedance is 200 ohms.

Housed in a metal cabinet 15 3/16 x 8 x 8 3/16 inches, it weighs 18 1/2 pounds.—RADIO-CRAFT

CONTACT CLEANER

Walter L. Schott Co.
Beverly Hills, Calif.

No-Ox is a neutral chemical contact cleaner and lubricant for use in electronic and electrical work. It dissolves corrosion and is especially suited for cleaning noisy volume controls, switch and relay contacts, and wipers on tuning condensers.—RADIO-CRAFT

**LIGHTNING ARRESTOR**

Radio Corporation of America
Camden, N. J.

The RCA Model 202611 lightning arrester is designed for FM and television installations. It has a plastic body designed to fit around 300-ohm transmission lines.

The transmission line is placed in an open slot in the plastic body and a plastic cap is screwed down, firmly, causing four sharp prongs to pierce the insulation and contact the wires. It avoids cutting and splicing of the line—usually necessary with other types of arrestors—which distorts incoming signals.

The arrester is mounted on any indoor water pipe with a flexible metal ground strap.—RADIO-CRAFT

TUNING CONDENSERS

E. F. Johnson Company
Waseca, Minn.

These new air variable condensers are the smallest ever built commercially. They are available in three models: single, differential, and butterfly types, and four different capacitances.

The single type is an adjustable pad-der for trimming r.f., i.f. and oscillator circuits. It is available in 1.55 to 5.14 μmf, 1.73 to 8.69 μmf 2.15 to 14.58 μmf, and 2.6 to 19.7 μmf.

The differential type switches capacitance from rotor to either of two stators, and also shifts the tap on a capacitance divider. Capacitances are 1.84 to 5.58 μmf, 1.98 to 9.30 μmf, 2.32 to 14.82 μmf, and 2.67 to 19.30 μmf.

The butterfly type is used wherever a small split-stator condenser is required. Four models include 1.72 to 3.30 μmf, 2.10 to 5.27 μmf, 2.72 to 8.50 μmf, and 3.20 to 11.02 μmf.

Features include: single hole mounting, flats on mounting bushings to prevent turning, beryllium copper contact spring, and steatite end frames.

Spacing is .017 inch and the breakdown voltage is 750 r.m.s. at 2 mc.—RADIO-CRAFT

COLORED TV LENS

Colomaf Corporation
New York, N. Y.

The Vue-Scope is a blue-tinted television magnifying lens which reduces eyestrain and glare.

The lens is made of two preformed lucite sheets. The convex front sheet is clear and the flat rear sheet is colored. Both sheets are first bonded together and the hollow space filled

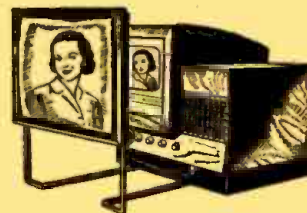

with clear mineral oil through a small opening which is sealed afterward.

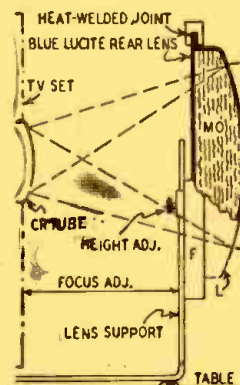

L = CLEAR LUCITE FRONT LENS
MO = MINERAL OIL (SEALED IN)
F = FRAME

A mounting bracket permits horizontal or vertical adjustment for screens of different sizes. Dimensions of the lens vary from 10 x 13 inches to 13 1/2 x 19 inches.—RADIO-CRAFT

PHONO NEEDLE

Duotone Company
New York, N. Y.

A new shockproof nylon phonograph needle reduces surface noise and needle talk. It has an osmium-tipped spring steel shaft set into a nylon bumper which acts as a shock absorber



er and also reduces noise. The radius of the osmium tip is .0028 inch plus or minus .0001 inch. The needle shank is duralumin and has a milled surface for one-way insertion into the pickup cartridge.—RADIO-CRAFT

RADIO-CRAFT for

RETURN OF THE VETERAN

By EMMETT BRIGHTWELL

A YEAR ago RADIO-CRAFT and other journals devoted to the interests of radiomen were filled with wails and editorial comment about the difficulties encountered by craftsmen then being discharged from the military services.

These complaints ranged from no credit, no parts, no wholesale contacts to flat refusal of manufacturers to grant sales franchises for standard products.

And there were *beaucoup* grounds for all the complaining; both wholesalers and manufacturers preferred to cling to their wartime outlets, knowing full well that it would be many months—years, maybe—before there would be enough goods to go round.

Recently I got to wondering if conditions had changed—if so, how. So I looked in on several veterans who had managed, since discharge, to get a toehold again in the radio service field. Some of these were willing to discuss conditions, some were not.

The most articulate of the few who would submit to an interview was Joe Solorzano, who operates a neat, if small, radio and appliance store, the Strand Radio Shop, at 3339 Twenty-Third Street, San Francisco.

Joe, before entering the service, was an experienced radio repairman. In fact, in the Coast Guard where he served, he was found so good that instead of being put through a radioman's training course, he was assigned to teaching others.

On discharge his problem was not to get parts and supplies. It was to find a store—or any room large enough to set up in. He finally secured the location he now occupies. Its area is not more than 250 square feet; one 10-foot counter across the entrance to the service department leaves just space enough for Joe to pass edgewise (Joe still has an edgewise) to and fro.

Joe has about \$2,500 invested here in fixtures, in test equipment, in stock. He is a facile worker, turns out guaranteed jobs, seldom has a comeback, tests tubes free, collects a basic service charge on every repair job, hardly ever does a repair outside the shop, and the only thing he will do to a receiver in the owner's home is run a tube test.

Joe uses various avenues of advertising. He keeps a running ad, with frequent copy changes, in the neighborhood newspaper, he distributes handbills periodically, and after nightfall his windows are a blaze of electric light and neon signs.

He thinks his window displays have the best drawing power. He is inaugurating a follow-up letter system to old customers with a view of encouraging and monopolizing repeat business.

But Joe has not to this day been able to get a dealer franchise. He sells a few off-brand receivers. But good, for Joe can tell a good receiver by just examining the layout and the parts, and he

TOP VALUE OFFERS



Kit Model FM-7, a Self-Contained Table Model Frequency Modulated Radio Receiver Kit

Model FM-7 has a frequency range of 86-110 Mc., can also be used as a TUNER with a high quality amplifier. A phonojack is provided in the rear of the chassis with double pole, double throw switch for feeding signal to either the radio speaker or to the phonojack. An additional jack for connecting extra loud speaker is included. The R.F. section of the kit is pre-assembled at the factory. This kit uses 2 IF stages, 1 limiter and 1 discriminator. Miniature tubes used throughout. Complete with tubes including beautiful bakelite cabinet, ready for assembly.



Kit Model 210, a Three Way Portable Receiver

Model 210 operates on either AC or DC or self-contained batteries... power switch conveniently located on front of set so that "battery" or "AC or DC" may be selected without opening case. Five inch Alnico 5 permanent dynamic speaker. Case covered with fine grade leatherette material. Complete with tubes, ready for assembly.



Kit Model S-5, a One Band Receiver

Model S-5... this radio kit contains the following features: improved superheterodyne circuit, built-in loop antenna, PM Alnico speaker, streamlined airplane dial, wide tuning range 550Kc-1600Kc, 5 tubes (including rectifier), 115V. AC-DC, 12SK7 IF 12SA7 converted, 12SQ7 Det. and 1st audio, 50L6GT output and 35Z5GT rectifier. Complete with tubes, including beautiful bakelite cabinet, ready for assembly.

Many other kit models available. Write for Catalog M

RADIO KITS COMPANY

120 Cedar Street New York 6, N. Y.

You Can Now Become A Prospector!

Here Is One Of The War's Top Secrets

BRAND (NEW) ARMY MINE DETECTORS!

Portable: Will Detect METALLIC and NON-METALLIC objects; Very Sensitive; using 955 Tube in detecting head; two tube amplifier using two 1N5gt; headset; or microphone; also 150 micro meter; Power supply; 3-45-v.; one 6-v.; or 2 3-v. batteries. Complete with instr. Less Batteries; packed in original cases; sbpd. wt. 108 Lbs.

F.O.B. from N. Y.

\$17.50
(Less Batteries)

\$26.40

With Batteries
F.O.B. N.Y.
NO C.O.D.
Send Order to



COLUMBO TRADING CO., INC.
304 Canal St., Dept. RC1, New York 13, N. Y.

PLEASE TEAR OUT THIS ADV. AS REMINDER

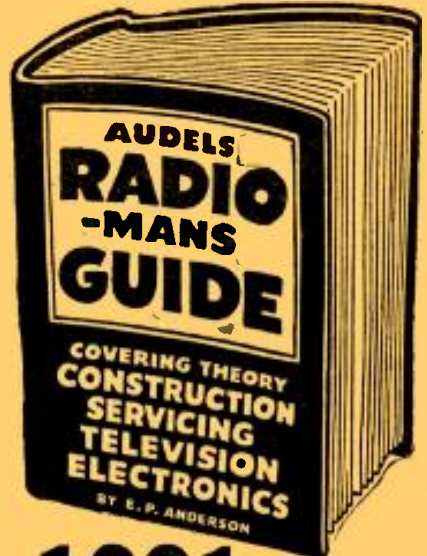

1001 RADIO FACTS AND FIGURES

AUDELS RADIO MANS GUIDE—914 Pages, 633 Illustrations, Photos, Wiring Diagrams, 88 Big Chapters, covering Radio Theory, Construction, Servicing, including Important Data on Developments in Television, Electronics and Frequency Modulation, Review, Questions and Answers, Calculations & Testing. Highly Endorsed—Indispensable for Ready Reference and Home Study.

\$4 COMPLETE • PAY ONLY \$1 A MONTH
Step up your own skill with the facts and figures of your trade. Audels Mechanics Guides contain Practical Inside Trade Information in a handy form. Fully illustrated and Easy to Understand. Highly Endorsed. Check the book you want for 7 days' Free Examination.

Send No Money. Nothing to pay postman.

CUT HERE MAIL ORDER

AUDEL, Publishers, 49 W. 23 St., NEW YORK 10, N. Y.

Please send me postpaid for FREE EXAMINATION books marked (x) below. If I decide to keep them I agree to mail \$1 in 7 Days on each book ordered and further mail \$1 monthly on each book until I have paid price—otherwise, I will return them.

- RADIO MANS GUIDE, 914 Pages . . . \$4
- ELECTRICIANS EXAMINATIONS, 250 Pages . . . 1
- WIRING DIAGRAMS, 210 Pages . . . 1
- ELECTRIC MOTOR GUIDE, 1000 Pages . . . 4
- ELECTRICAL DICTIONARY, 9000 Terms . . . 2
- ELECTRICAL POWER CALCULATIONS, 425 Pgs. . . 2
- HANDY BOOK OF ELECTRICITY, 1440 Pages . . . 4
- ELECTRONIC DEVICES, 216 Pages . . . 2
- ELECTRIC LIBRARY, 12 vol., 7000 Pgs., \$1.50/vol. . . 12
- OIL BURNER GUIDE, 384 Pages . . . 1
- REFRIGERATION & Air Conditioning, 1280 Pgs. . . 4
- POWER PLANT ENGINEERS Guide, 1500 Pages . . . 4
- PUMPS, Hydraulics & Air Compressors, 1658 Pgs. . . 4
- WELDERS GUIDE, 400 Pages . . . 1
- BLUE PRINT READING, 416 Pages . . . 2
- SHEET METAL WORKERS Handy Book, 388 Pgs. . . 1
- SHEET METAL PATTERN LAYOUTS, 1100 Pgs. . . 4
- AIRCRAFT WORKER, 240 Pages . . . 1
- MATHEMATICS & CALCULATIONS, 700 Pgs. . . 2
- MACHINISTS Handy Book, 1600 Pages . . . 4
- MECHANICAL Dictionary, 968 Pages . . . 4
- AUTOMOBILE GUIDE, 1700 Pages . . . 4
- DIESEL ENGINE MANUAL, 400 Pages . . . 2
- MARINE ENGINEERS Handy Book, 1280 Pages . . . 4
- MECHANICAL DRAWING GUIDE, 160 Pages . . . 1
- MECHANICAL DRAWING & DESIGN, 480 Pgs. . . 2
- MILLWRIGHTS & Mechanics Guide, 1200 Pgs. . . 4
- CARPENTERS & Builders Guides (4 vols.) . . . 6
- PLUMBERS & Steamfitters Guides (4 vols.) . . . 6
- MASONS & Builders Guides (4 vols.) . . . 6
- MASTER PAINTER & DECORATOR, 320 Pgs. . . 2
- GARDENERS & GROWERS GUIDES (4 vols.) . . . 6
- ENGINEERS and Mechanics Guides . . . 4
- Nos. 1, 2, 3, 4, 5, 6, 7 and 8 complete . . . 12
- Answers on Practical ENGINEERING . . . 1
- ENGINEERS & FIREMANS EXAMINATIONS . . . 1

Name _____
Address _____
Occupation _____
Employed by _____ R.C.F.

GREEN Your "GO-AHEAD" for Values!

VOLUME CONTROLS

Made by a nationally known manufacturer. Standard noise-free carbon construction — 3/8" bushing — 1/4" shaft, 3" long—complete with switch. Ideal all purpose replacement control. Full range of sizes—with attached switches! In the following Ohms
10M—25M—50M—250M—500M—1 Meg—2 Meg
59c Ea. \$55.00 per 100 Assorted
The above are top quality products—do not confuse them with cheaper controls on the market now.

A "GREEN" SUPER SPECIAL STANDARD VOLUME CONTROL WITH SWITCH
500,000 OHMS

Mfg. type, 500,000 ohm famous and popular control, complete with D.P.S.T. switch and mtg. nut. 2 3/4" shaft. All brand new. A terrific bargain, while they last **29c**

FREE! FREE!
RESISTOR COLOR CODE GUIDE with every order

CODE KEY

Type J38

Made to U.S. Army Signal Corps specifications at a cost several times our price. Has bakelite base 3/16" thick. Every one brand-new in individual box. **Special Each 95c**



INSULATED RESISTORS

100—500,000 ohm 1/2 watt
Plus or minus 10% R.M.A. Color Coded.
Reg. Price \$8.00 **SPECIAL \$2.00**



INVERTED SCREW MTG. ALUMINUM CAN CONDENSERS

These condensers are manufactured to operate satisfactorily under the severest conditions. Etched foil construction. Completely insulated. Separate negative and positive leads for each section. Flat nut furnished with each condenser.

Cap. Mfd.	W.V.	Each
8	475	.69
12	475	.81
20	475	.98
8+8	475	1.15
40	450	.99

TUBE SPECIALS

BRAND NEW—STANDARD BRAND

Type	List	Our Special	Type	List	Our Special
1A7GT	1.80	.72	35W4	1.45	.46
1H5GT	1.50	.60	35Z5GT	1.15	.46
2A7	2.20	.88	70L7GT	3.90	1.56
6A K5	3.90	.95	75	1.50	.60
6C4	1.50	.25	6AC7	2.65	1.06
6J6	2.65	.79	0Y4	3.90	.88
17L7GT	3.55	1.42	25Z6GT	1.35	.54
35B	1.80	.72			

OTHER SPECIALS

20 Amp Auto Fuses, SFE 100 . \$2.00
14 Amp Auto Fuses, SFE 100 . 2.00
Rubber Male Caps05
.5—600 V Tubular Condensers24

RESISTANCE LINE CORDS

Individually boxed in the following Ohms

135	220	330	List \$1.20 ea.
160	250	350	SPECIAL
180	290	390	49c Ea.
200	300		

12" Walnut Wall Baffles, sturdily constructed. \$ 3.75
G.I. Dual Speed Photo Motors—33 1/2—78.
Real heavy duty a close out 17.50
3 Section Auto Antenna, side cowl mount, 26 to 66", low loss lead. 1.39
Duotone genuine Sapphire Needles, 5000 plays . .49
5"—450 Ohm Dynamic Speaker with 50L6 output Trans. a few at 1.95
Astatic Dynamic Microphone, Bullet type, complete with 15' of Mic. Cable a steal at 10.95
Recording Wire—15 Min. \$1.30; 30 Min. \$1.95; 60 Min. 3.25
Socket Wrench Sets, self container with 6 wrench sizes31
Nylon 1 1/2 Crystal Cartridges List \$8.80
Our Price 3.69
25" Rubber covered Hanks16
15 Watt—clear G-E Mazda Lamps07
Turner Crystal Microphones with 100' Mic. Cable. For the price of mic. Cable. 6.95
Portable Record Player with Auto. chanker, 3 tube built-in amplifier, 5" speaker, beautiful brown carrying case 32.47

ALL MERCHANDISE BRAND NEW AND 100% GUARANTEED NO SECONDS! NO REJECTS! NO OFF-BRANDS! STANDARD BRAND MERCHANDISE ONLY

20% Deposit required with C.O.D. Orders. All orders FOB New York. Minimum orders \$2.00.

GREEN RADIO DISTRIBUTORS
THE HOUSE OF BARGAINS
Electronic Supplies & Equipment
482 SUTTER AVE. DL. 2-4444 BROOKLYN, N.Y.

RETURN OF THE VETERAN

(Continued from page 71)

aims all the time at customer satisfaction.

"I do not feel that just because a man was in the service he should feel entitled to any special consideration from either the public, the manufacturers, or the financing agencies," Joe said. "After all, free enterprise is based upon free competition, and a radio serviceman may as well realize that, if he is to stay in business, it will be because he can do a good job; he can't rely wholly upon public good will to get business and goods and money to finance them."

The writer liked Joe's shop, his methods of doing business, and, above all, his attitude, so well that he took a picture of Joe doing a job at his workbench.

Joe does not think there are too many service shops. He is making a living for his family of four. He believes he could do a great deal better if he had more space in a higher-income community.

But with store space growing scarcer and scarcer, and rentals going higher and higher, he thinks he will quit looking for a better location and make the best of what he has.

Joe is not looking forward to any-

thing startling in the near future in the field of television or any other department of radio or electronics. He thinks the industry will stick closely to proven items and designs, things for which a market already exists, things which are known to have a ready sale, and that



Satisfied customers and a well-planned advertising campaign help to make Mr. Soloranzo's small radio and appliance shop profitable.

this attitude will tie up most manufacturing equipment and raw materials for a long time to come.

And in the meantime, a lot of the radionic wonders of today will become the has-beens of tomorrow without having caused a single ripple on the waters of public interest.

Joe, you see, is conservative.

PRODUCTION-LINE TECHNIQUE FOR SERVICE SHOPS

By Jack King

ORGANIZING your servicing routine has definite advantages. For example, the sequence may run:

1. Receiving the radio;
2. Identifying the set by attaching a tag;

3. Examining the receiver to determine its faults;

4. Correcting the faults and repairing the radio;

5. Returning the set to the customer;

6. Receiving payment and ringing the cash register.

Police

CALL FANS

HERE IT IS

TUNES 152-162 MEGACYCLES
6 Tube (miniatures) True F.M. Superhetrodyne including rectifier. 115 Volts, A.C.-D.C. 5 Inch speaker. Clear vision dial. 9 1/2 x 6 1/4 x 5 1/4 deep, walnut veneer cabinet. Shipping weight 5 1/2 lbs. Highest quality components. Schematic inside back cover. 2 stages high gain 10.7 Megacycle I.F.s. High Selectivity. Discriminator Detector. Guaranteed reception from your local F.M. Transmitters with attached antenna, from cabs, police and others. Ready to plug in and use.

LIST
\$39⁹⁵
Excise Tax Included
F.O.B. Indianapolis
\$10.00 Cash With Order
Rest C.O.D.

SOME CHOICE DEALERSHIPS STILL AVAILABLE — BE FIRST — WRITE

RAC

POLICALARM

RECEIVER

RADIO APPARATUS CO.
729 NORTH BANCROFT ST.
INDIANAPOLIS (1), INDIANA

Note that there are six definite steps. A certain amount of time is required to perform each operation. In a factory time study analyses of the work performed are made to see how time can be saved by eliminating unnecessary steps, or by conserving the time of specialized individuals by diverting certain parts of the work to less-well-trained persons. Why not apply this technique to servicing shops? In the above sequence, 3 and 4 require actual technical knowledge.

Why, then, waste the time of the technical man by having him deal with the customer? Who wouldn't rather deal with a good-looking blonde? At times it is admittedly essential that the serviceman be present to talk with the customer, but in most cases his time can be conserved and he can concentrate on technical work if suitable people are employed to do the routine jobs.

What factors enter into step 1? First, the owner should be queried about the complaint. Leading questions should be asked. The following are typical:

1. What sort of trouble are you having?
2. Is the noise heard at all times of the day or only at particular times?
3. Does the hum appear after the set has warmed up or immediately?
4. Do you hear the distortion at once or does it take some time to develop?
5. Do you wish an estimate first or will it be all right to go ahead and repair the set?

(It is usually safer to give an estimate.)

The tag which identifies the set (step 2) should be attached firmly to the radio's power cord.

The tag itself may be streamlined, just as streamlining is used in production-line methods. The first thing of importance is the owner's name. This is placed at the top of the tag and is the first thing written down. The number of the tag and the date should also be at the top. Then, the owner's address, telephone number, receiver make and model number, serial number, and nature of complaint. To facilitate filling out the tag, such words as hum, noise, intermittent, etc., may be printed on the tag, with a small box or space opposite each word. This eliminates the necessity of retelling the story to the serviceman. He can glance at the tag and quickly see what the complaint is and what the job entails.

The actual servicing

Step 3, examination of the receiver to determine its faults, may require considerable time. Intermittent receivers may take hours to repair instead of minutes. The time required can be cut down by first of all making certain that the technician has a thorough technical training and really knows the fundamentals of radio. Without basic knowledge, efficient servicing is out of the question.

Good, conveniently arranged, test equipment is a big help in diagnosing trouble. Depending on a nontechnical assistant to test tubes is not good practice. Most of the bad tubes may be

FM CONDENSER & COIL KIT (88 to 108 Mc)

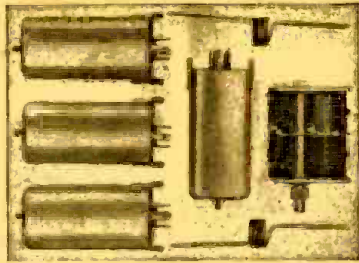

- Variable Condenser
 - Discriminator Coil
 - Oscillator Coil
 - Two I.F. Coils
 - Limiter Coil
 - Antenna Coil
 - Schematic Diagram
 - Instructions
- This Kit contains the vital parts needed to build an FM Tuner or Radio and for modernizing Pre-War FM Sets; all other parts needed are standard. **\$4.95**

AUTO RADIO

- Six Tube Superheterodyne
- Three Gang Condenser
- Powerful Long Distance Reception
- Fits All Cars, Easy Installation
- Mounting Brackets Included



\$29.97
Net



TOM THUMB CAMERA RADIO

- Precision Built
- Excellent Tone Quality
- Full Vision Slide-Rule Dial
- The Ideal Vacation Companion
- A PORTABLE RADIO for Battery Operation
- A HIGH GRADE CAMERA with Reflex Lens Using Standard 127 Film & 16 Pictures.

\$28.75
Net
Less Batteries

BROOKS RADIO DIST. CORP.
80 Vesey Street, Dept. A, New York 7, N. Y.

The Trade Mark of "Time-Tested Quality"

ILLINOIS

CONDENSERS BELONG IN THE BEST

Electronic Sets

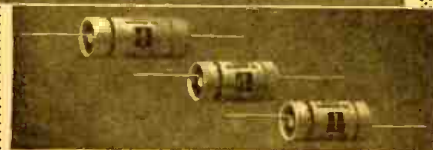

- Look to Illinois for a complete line of electrolytic capacitors for every electronic application and radio replacement use. When you need a capacitor that has superior ability to withstand extreme temperature changes, that's manufactured to exacting specifications, that's time-tested through 14 years of high quality production experience—you want an Illinois condenser!

• WRITE FOR OUR LATEST CATALOG

ILLINOIS CONDENSER CO.
1616 NORTH THROOP STREET - CHICAGO 22 ILL.

RADIO TROUBLESHOOTER'S HANDBOOK

Eliminates useless testing on 4 jobs out of 5



...YOUR COMPLETE PRACTICAL RADIO SERVICE LIBRARY

...in two giant books



MODERN RADIO SERVICING

A complete guide to troubleshooting, instruments, circuit analysis, repair.

LEARN TO WORK BY MODERN, PROFESSIONAL METHODS

Train for the big pay jobs!

Ghirardi's MODERN RADIO SERVICING is a complete, 1 vol. course in all phases of professional radio-electronic repair. Tells how to make preliminary trouble checks on difficult jobs; how to analyze any circuit and its components; how, when and where to use all types of test instruments and interpret their readings to track down the trouble—even how to start a service business of your own. Everything is explained simply and thoroughly. 706 clear illustrations and 723 self-test review questions make study easy. Complete 1300-page book only \$5—or see special combination price offer below.

CUT TIME IN HALF ON COMMON SERVICE JOBS

2 Work faster—make more money

Almost 4 out of 5 radio repair jobs can be handled as easily as falling off a log! Just look up the model of the set to be fixed. Chances are Ghirardi's RADIO TROUBLESHOOTER'S HANDBOOK tells exactly what the trouble is, exactly how to fix it. Gives common troubles, their symptoms and remedies for over 4800 radios by 202 manufacturers. Hundreds of additional pages contain tube data; transformer trouble listings, alignment charts and dozens of diagrams, etc. for faster, better service on any radio ever made. Only \$5—or see special combination offer.

MONEY SAVING OFFER!

Let Ghirardi's RADIO TROUBLESHOOTER'S HANDBOOK save time, help you make more money on common service jobs. Let MODERN RADIO SERVICING train you in truly scientific servicing that can pave your way to the big money jobs. Get BOTH big books at the special price of only \$9.50 for the two (\$10.50 foreign). Use coupon today—at our risk!

Read these GIANT books for 5 DAYS ... at our risk!

- Dept. RC-68, Murray Hill Books, Inc., 232 Madison Ave., New York 16, N. Y.
- Enclosed find \$_____ for books checked; or
- send C.O.D. (no C.O.D.'s outside U.S.A.) and I will pay postman this amount plus a few cents postage. In either event, I may return books within 5 days for complete refund of my remittance.
- MODERN RADIO SERVICING \$5 (\$5.50 outside U.S.A.)
- RADIO TROUBLESHOOTER'S HANDBOOK \$5 (\$5.50 outside U.S.A.)
- SPECIAL MONEY-SAVING OFFER both of above big books only \$9.50 (\$10.50 outside U.S.A.)

Name _____
Address _____
City & Zone _____ State _____

SUPER VALUES from MID-AMERICA!

Stromberg-Carlson DYNATENNA

This famous-make FM antenna has been advertised and sold for many times the low price MID-AMERICA asks! Covers both FM bands. Delivers FM reception at its best. Complete with 60 ft. of 300-ohm twin lead-in. Line is standard approved flat-type, solid dielectric with weather-resisting insulation. Mounts anywhere easily... vertically or horizontally to match polarization of trans-

mitting station. Illustrated instructions and all necessary hardware. A screwdriver is only tool needed for assembly. Dynatenna is seamless, heat-treated, all aluminum... will withstand severest weather.

\$4.95

each
\$4.45 each
in lots of 3



PERMEABILITY TUNER

Build a really HOT 5 or 6-tube A.C.-D.C. superhet receiver! Takes place of old-style gap condenser, of antenna coils: regular 465 KC intermediate frequency. **MA-2167** Complete with permeability tuned oscillator coil. 4" x 2 3/4" x 2 3/4"; 2 3/4" diameter dial drum. Complete with diagrams for building 5 and 6 tube sets. Order **MA-2169** Loop Antenna **15c**
Order **MA-2914** Drilled, punched Chassis **39c**

BANTAM 1-WATTER

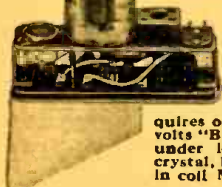

BCR-746-A tuning unit used as foundation for Bantam 1-Watter described in Jan. 1948 QST. Makes tiny crystal-controlled CW transmitter. Measures only 3 1/2" long, 2 1/2" high, 1 1/2" wide. Requires only 1 1/2 volts "A", 30 to 90 volts "B". Draws 8 to 15 ma under load. Supplied less crystal, IS4 tube and plug-in coil **MA-907**. **24c**

SPECIAL AUDIO TRANSFORMERS

Exceptionally high-quality universal output transformer for up to 12" speakers. Rated at 12 watts. Matches any single, push-pull or parallel tubes to 6-8 ohm voice coil. 12" color-coded leads. 2" high with 2 3/4" mounting centers for installation on chassis or speaker. Complete with instructions for matching tube impedances. **MA-1205 \$1.19**

Hermetically sealed 200 ohm CT to 50,000 ohm grid. Uses microphone transformer, line-to-grid, etc. 2 1/2" x 1 1/4" x 1 1/4". **MA-1262 69c**

Single 3000-ohm to 4-ohm voice coil output for 50L5, 35L8, etc. 1 1/2" high on 8 1/4" mounting centers. **MA-1255 . . . 49c**

Heavy Duty Noise Filters

Rated on 10 amps, 115-volt AC. Measures only 1" x 1 1/2" square. Install right in amplifiers, receivers and other equipment where line noises must be kept at a minimum. Nationally-known manufacturer. **MA-2164 . . . 79c**

Filter for mobile power supplies. Rated 10 amps, 6-30 VDC. Has additional 2 mfd, 100 VDC condenser. 2" high, 2" square. **MA-2165 . . . 59c**

SPEAKER SPECIALS

All with Heavy ALNICO 5 Slugs

3 1/2" PM MA-206 2 . . . \$1.39 4x8 Oval PM MA-2187 \$1.39
5" PM MA-2071 . . . \$1.39 6" PM MA-2189 . . . \$1.95

ORDER FROM THIS AD!

Quantities are limited, so get your order in now! Minimum order shipped, \$2.50. Send 25% deposit, balance C. O. D. Get on MID-AMERICA's mailing list to receive BIG BARGAIN BULLETINS that list latest, greatest buys in radio parts, electronic equipment. Send orders to Desk BC-68.

MID-AMERICA CO. Inc.

2412 S. Michigan Avenue
Chicago 16, Ill.

Servicing

caught by the inexperienced person, but often a tube which shows an intermittent short or leakage on the tube tester will get by all but the technician. Shortening this step, then, depends greatly on technical knowledge and good test equipment. Cheap and inaccurate test equipment results in loss of time and money. Thought directed toward efficient placement of the equipment on the bench is well worth the effort.

Once the fault has been located, it must be corrected (step 4). This invariably means that a part must be taken out of stock or ordered. Naturally, the more parts kept in stock, the faster is the service. It is always easier to take a part out and install it than to order it from a distributor with attendant red tape and delay. But the stock that can be kept on hand is usually limited because of lack of space and money. An analysis over a period of time (say six months) of the parts ordered can be made. Certain parts will be ordered and re-ordered. In rural districts there may be a demand for battery radio parts. Portable and a.c.-d.c. radios may be widely used in d.c. districts, necessitating repeated ordering of a.c.-d.c. chokes, 150-volt electrolytic condensers, and high-voltage-filament tubes such as 43's, 35Z5's, and 50L6's. If the demand for the past six months is known, the next six months' demand can be fairly well predicted. Parts which are very often used, therefore, should always be kept in stock.

A convenient and neat storage system, with bins or compartments, kept clean and orderly, is necessary to avoid wasting a lot of time looking for parts. Some service shops look like haywire nightmares. Resistors may be neatly sorted in drawers or boxes. Paper and electrolytic condensers similarly may be kept in proper order. Tubes should be stocked in orderly fashion for easy identification.

Correcting faults also depends on the technician's skill. Replacing a loud-speaker cone or a dial drive cable can be a tricky job which takes more time than necessary unless skillfully done. Time spent in analyzing the necessary steps to speed servicing is worth while. If the shop employs more than one man, each one can specialize in certain types of work. Servicing of record changers, for example, calls for more mechanical than electrical or radio skill, and some men are able to do this work better than others. Some men are at their best installing or repairing auto radios.

Bulky circuit manuals are somewhat difficult to handle and take up considerable room on the test bench. If the diagrams are taken out and filed in a filing cabinet, a single diagram at a time may be removed as needed.

Step 6, receiving payment and ringing the cash register, is the easiest of all in many respects, and yet the hardest, for before it can be performed the preliminary five steps must be finished. Cash and carry is a good rule to follow. Paper debts are of no value. Arguments will be avoided by giving clear estimates and expecting the customer to pay promptly when the work is done.

RADIO-CRAFT for

ONLY **\$89.50** IS THE COST!

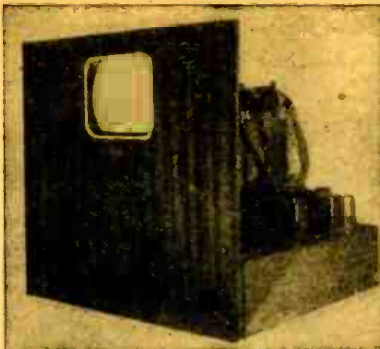

for the SENSATIONAL-NEW-IMPROVED 10 INCH TELEVISION KIT

less tubes
Complete with 13 channel tuner, all parts and easy step-by-step following instructions and schematics.

\$89.50 less tubes

Kit complete with all tubes \$149.50
Cost of cabinet \$25.00

Using the new 13 CHANNEL TUNER which is pre-wired and factory aligned for the entire television spectrum. The kit builder merely installs this unit into his chassis and makes three connections. Contains an R.F. stage, oscillator and mixer. It is extremely small and compact. Using new I.F. coils which provide maximum gain and picture definition. Sound reception is high quality F.M. for complete listening pleasure.

SAME TELEVISION KIT—7 INCH. complete less tubes \$59.50; complete with all tubes \$99.50

IMMEDIATE DELIVERY FROM STOCK

Metropolitan ELECTRONIC & INSTRUMENT CO.
Dept. RC 42 WARREN ST. N. Y. 7, N. Y.



OPERATES
ENTIRELY
FROM 110
VOLTS AC/DC

THE METER MASTER

FOR RADIO REPAIRMEN, . . .
STUDENTS, . . . HAMS.

Precision resistors eliminated by means of sliding resistors. No complicated switches to confuse you. Special design decreases crowding at high resistance end of ohmmeter scale by automatically increasing internal voltage. 30 minutes to assemble. Large 3 3/4" meter insures accuracy. Meter scale blank except for 1 m.a. range. Calibrations easily printed in.

RANGES:
Low Resistance: 1 ohms to 500 ohms
High Resistance: 0-1 Meg./10 Meg.
Current: 0-1/10/100 m.a.
D.C. Volts: 0-10/100/-500/5000
A.C. Volts: 0-10/100/-200

COMPLETE KIT
with INSTRUCTIONS
Case not included.
\$16.75

ORDER TODAY

METER MASTER

BOX 51 BERKELEY, CALIF.

25,000 repaired loud speaker paper cones PROVE the CONE PATCH cement saves you TIME and MONEY. CONE PATCH, musical cement, positively does not warp cones. Reproduces all musical vibrations, is almost invisible and stronger than rew. 100% satisfaction guaranteed or money refunded. Post card brings folio. 12 CONE SIZE bottle of CONE PATCH-KIT \$1.25 postpaid. Free VOICOLA solution, for warped V.C. cones. Inquiries invited from salesmen and jobbers.
RADIO RESEARCH PRODUCTS
W. MOLLOY, Director
6417 Harper Ave. Chicago 37, Illinois

CONNECTING FM TUNERS

By ALBERT LOISCH

MANY radio receivers have a jack at the rear of the chassis for connecting external FM tuners or record players. If a set does not already have an input jack, it is easy to install one with only minor changes in the original wiring.

The first step is to determine the best part of the circuit for the input jack. Modern receivers have diode or duplex-diode detectors, and connections to these circuits are simple.

Connect a d.p.d.t. switch in the lead from bottom of the i.f. filter (usually a 50,000-ohm resistor) to the volume control, and the B-plus lead to the r.f. section as shown in Fig. 1. Throwing the

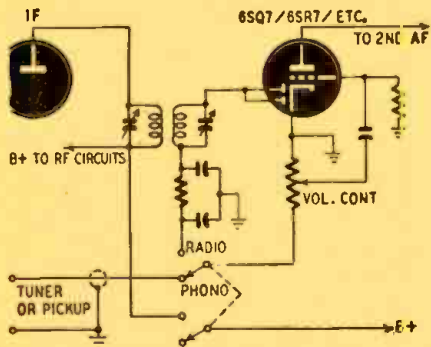

Fig. 1—Connection circuit for modern sets.

switch to the phono position switches the tuner or record player into the audio section of the set and disables the radio section.

Many of the older radios use the ancient biased-grid detector. Fig. 2 shows how to connect a phono jack to a detector of this type.

A separate bias resistor is used to get the correct grid voltage for phono operation. In the phono position, the switch cuts out the high-bias resistor and switches in on one of lower value.

To calculate the size of the new resistor, divide the desired bias voltage by

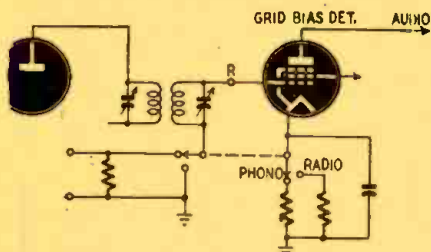

Fig. 2—Connecting phono to older receivers.

the cathode current. For example, if the required bias voltage is 13.5 and the current is 5 ma, at this bias voltage, then the value of the resistor is:

$$\frac{13.5}{.005} = 2,700 \text{ ohms}$$

Receivers with biased grid detectors usually have r.f. volume controls which permit cutting the sensitivity to zero. If the set does not have this control, it will be necessary to install a switch to open the B-plus lead to the r.f. section or otherwise disable the front end.

In most receivers, especially those

(Continued on page 76)

NOW AVAILABLE!

Amplifier for GE pickup



New circuits for the first time enable you to attain full benefit from the new General Electric Model DL 1RM 6C Variable Reluctance Magnetic pickup. Employs an exclusive, humless (DC on heafers) pre-equalized pre-amplifier to produce the most satisfying musical amplifier the world has ever known. If you are a perfectionist, you are the one for whom the ACA-100GE was designed. Send for technical literature.

AMPLIFIER CORP. of AMERICA

398-10 Broadway • New York 13, N. Y.

BARGAIN SPECIALS



MASTER-REMOTE INTER-COMS

Push button selection for 1 to 5 remote stations from this quality built 4 tube, 2 watt Master station. Several remotes can be "paged" at one time. Remote stations can originate call to Master. Very simple to install with any 3 conductor cable. Sturdy, good looking wood cabinets, walnut finished. Master 12 x 7 1/4 x 6 1/4", Remote 6 1/4 x 7 x 4"
 No. 32A234X, Master Station and One Remote—ONLY \$29.95
 No. 32A235X, Additional Remote Stations—ONLY \$7.88
 No. 2A113, 3 Conductor Cable—100 Foot \$2.60

THE "DOUBLE TWENTY" FLUORESCENT UNIT

- Plugs in Any Outlet
- Hangs in Any Position
- Underwriter's Approved



Improved heavy steel, high reflection baked white enamel inside, gray outside. Hangs anywhere, with wire or chain, in a "jiffy." With 6 foot attached cord ready to plug in any outlet. Ideal for your hobby nook, repair shop, store, etc. Shipped complete with two 20 watt lamps. Size 25 1/4 x 9 1/4 x 5 3/4", wt. 10 lbs.
 No. 30A60 \$8.28⁶ at
 Spec. Each \$7.73

WRITE FOR YOUR COPY OF CATALOG No. 481 IF YOU DID NOT RECEIVE IT.

BURSTEIN-APPLEBEE Company
 1012-14 MCGEE STREET
 KANSAS CITY 6, MISSOURI

GREYLOCK
 A Dependable Name in RADIO TUBES

GT, Glass, and Miniature Types. All Tubes, Individually Boxed.
 12SA7, 12SK7, 12SQ7, 50L6, 12AT6, 12BA6, 12BE6, 35W4, 50B5 each 39c
 1R5, 1S5, 1Y4, 354, 304, 6AK5, 6AC5, 6AC7, 6AQ5, 6BE6, 6BA6, 6AU6, 6BJ6, 6X4 each 49c
 32L7, 70L7, 117L7 each 59c
 All Tubes carry RMA 90-Day Guarantee

PM SPEAKERS

4" Alnico No. 5 each \$1.19
 5" Alnico No. 5 each 1.29

TERMS: Net COD. No order accepted for less than \$5.00
 WRITE FOR BARGAIN CATALOG C-6
GREYLOCK ELECTRONIC SUPPLY CO.
 30 Church Street New York 7, N. Y.

No More GUESSWORK



with
OHMITE
Little Devil

COMPOSITION RESISTORS

You never have to guess about the resistance and wattage of any Little Devil resistor. Every unit is not only color-coded but individually marked for quick, positive identification. Millions used in critical war equipment. Standard RMA values from 10 ohms to 22 megohms, in 1/2, 1, and 2-watt sizes. Tol. ± 10%. Also ± 5% in 1/2 and 1-watt sizes.

Available Only Through OHMITE Distributors

Ohmite Manufacturing Co.
 4896 Flournoy St., Chicago, Ill.



OHMITE

AMPERITE MICROPHONES

The ultimate in microphone quality, the new *Amperite Velocity* has proven in actual practice to give the highest type of reproduction in Broadcasting, Recording, and Public Address.

The major disadvantage of pre-war velocities has been eliminated—namely “boominess” on close talking.

- Shout right into the new *Amperite Velocity*—or stand 2 feet away—the quality of reproduction is always excellent.
- Harmonic distortion is less than 1%. (Note: best studio diaphragm mike is 500% higher.)
- Practically no angle discrimination . . . 120° front and back. (Best studio diaphragm microphones . . . discrimination 800% higher.)
- One *Amperite Velocity* Microphone will pick up an entire symphony orchestra.



P.G. Dynamic Models P.G.H. P.G.L. List \$32.00

Address Inquiry attention Dept. RC

STUDIO VELOCITY, finest in quality; ideal for Broadcasting and Recording.

Models R80H-R60L — List \$80.00

There is an *Amperite* Microphone for every requirement.

WRITE FOR ILLUSTRATED 4-PAGE FOLDER giving full information and prices.

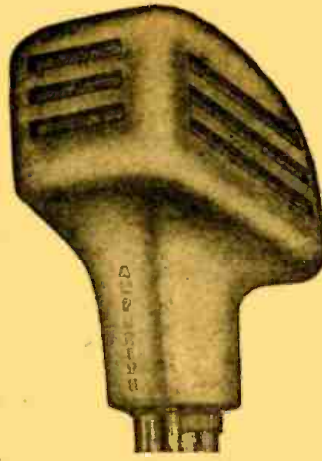

AMPERITE Velocity Microphones for Public Address Models RBHG, RBLG List \$42.00



“Kontak” Mikes Model SKH. list \$12.00 Model KKH. list \$18.00

AMPERITE Company, Inc.

561 BROADWAY NEW YORK 12, N. Y.

In Canada: Atlas Radio Corp. 560 King St. W. Toronto, Ont.

WRIGHT VERIFIED SPEAKERS They Glorify the Tone

WRIGHT, Inc.

2234 University Avenue

St. Paul 4, Minn.

CONNECTING FM TUNERS

(Continued from page 75)

with high-gain audio amplifiers, it may be necessary to shield all the input leads to the audio tubes to prevent instability.

Remove any remaining instability by connecting a small carbon resistor of from 10,000 to 50,000 ohms in the input

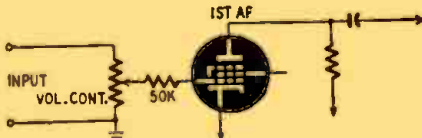

Fig. 3—Grid resistor eliminates instability.

circuit of the first audio stage (Fig. 3). Do not use the resistor unless the shielding fails to clear up the trouble. In all cases of audio oscillation, check the bypass and electrolytic condensers, and the de-coupling filters before making any changes in the circuit itself. Motor-boating or other forms of oscillation often appear when the switch is thrown to the radio position, due to the extended wiring and the capacity of the switch. If the oscillation still cannot be elimi-

nated, try feeding the input voltage from the pickup or tuner to the second audio stage.

Where the receiver's volume control has no effect on the signal from the pickup, it will be necessary to mount an additional control either on the receiver chassis or at the pickup. Some FM tuners have a volume control already installed. If the pickup is of the high-impedance type, connect a potentiometer directly across the two leads, (Fig. 4). The exact value will depend upon the impedance of the pickup, usually from 50,000-ohms to ¼ or ½ megohm. See the manufacturer's recommendation.



Fig. 4—A high-impedance pickup and control.

An FM tuner is designed to connect to a high-impedance circuit, so if it is necessary to attach a volume control to

it, one of at least one megohm resistance should be used.

To connect a low-impedance pickup, use a matching transformer between it and the amplifier. A high-ratio audio transformer or a microphone transformer with a tapped primary may be



Fig. 5—Connections for low-impedance pickup.

used if the original pickup transformer is not available. Connect the volume control across the transformer secondary as shown in Fig. 5.

LOW-FREQUENCY TIMER

A SHORT time ago I needed an automatic switch which would turn low-voltage bulbs on and off at regular intervals. The circuit described here proved very satisfactory and versatile for the purpose.

As the filaments heat, the plate current rises gradually until it equals the operating current of the relay. Then the contacts open and break the filament circuit. The plate current then drops slowly until the relay releases and closes the circuit again, causing the cycle to repeat. If desired, a low resistance can be added across the relay contacts to vary the cooling and heating periods.

The operate and release periods depend mainly upon the type of tube and relay, but also to some extent on the

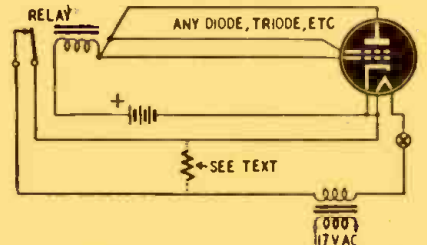

Circuit of the automatic vacuum-tube timer.

voltages used. Low-voltage, high-current tubes are slower heating and cooling, giving longer timing periods. The small battery types give shorter cycles. Tension of the relay springs also has a marked effect on the frequency of operation.

Any tube may be used in this circuit, from a diode up to the more complicated types. Grids may be either connected to the plate or left floating. I have used a 6H6 with diodes in parallel operating with as little as 1.5 volts on the plate. The plate current is then sufficient to operate a very sensitive 1,500-ohm relay at about 0.55 ma. On and off periods were about 15 seconds each.

The timer is suitable for starting motors or lights periodically for display purposes. If a single-pole, double-throw arrangement is available on the relay, the ON position can close one circuit while the OFF position closes another. The circuit is also readily adaptable to time-delay uses, such as turning on high voltage to a mercury-vapor rectifier after some predetermined time interval.—I.Q.

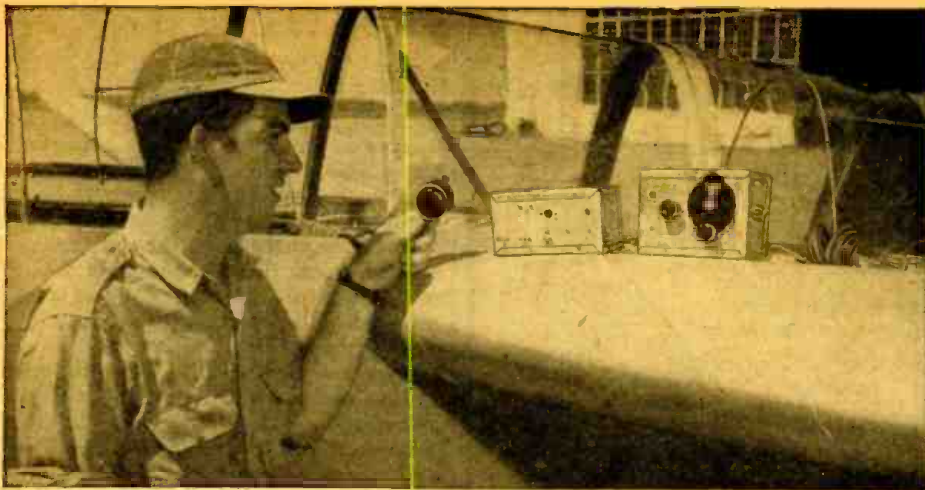

Gliding enthusiast Fritz Compton with the 1/2-watt transmitter he made for his sailplane.

A Sailplane Transmitter

By FRITZ COMPTON

SAILPLANE pilots often take advantage of thermals and other currents aloft to make motorless flights of a hundred miles or more. Generally, the pilot lands in a convenient pasture or meadow to await the arrival of his ground crew with tow car and trailer. During a flight the usual procedure is for the ground crew to try to average 20 to 25 m.p.h. over highways in the general direction of the flight. When conditions aloft force the pilot to alter his course, the ground crew may be many miles away when he lands.

During the 1946 National Soaring Contest at Elmira, N. Y., the author completed a 151-mile soaring flight to a point near Trenton, N. J. Midnight found him in a clover field with his sailplane, still awaiting the ground crew and sailplane trailer. The landing had been made 8 hours earlier, and the ground crew contacted some time later by telephone through contest headquarters at Elmira. After this experience, the author built this 1/2-watt, 10-meter transmitter for keeping in contact with the ground crew through a receiver in the tow car.

The half-watt was designed for low battery drain and light weight—weight is a critical factor in the performance of sail planes. Miniature tubes were used for compactness. (Although this unit was designed for use in a sailplane, it is an ideal unit for use on a bicycle, motor-cycle, small boat, or even on a hike. (We'll bet that this little rig will "go

places" if used with a beam or properly tuned long-wire antenna.—Ed.)

The fleo-power circuit

The transmitter uses a 3S4 7-mc triet oscillator, doubling to 14 mc in its plate circuit. The final stage is a 3R4, Heising modulated with a class-A 3A4 amplifier. The oscillator coils L1 and L2 are interwound on a 1-inch form. Each has eight turns of No. 20 d.c.c. wire. It is preferable to use different colored wires to simplify making connections to the coils. The 14- and 28-mc tanks L3

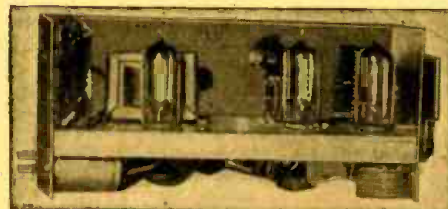

Rear view of the 10-meter plane transmitter.

and L4 are self-supporting coils with an inside diameter of 3/4 inch. They have 19 and 10 turns, respectively. Both are wound with No. 14 enameled wire, spaced the diameter of the wire. The antenna coil L5 is two turns of insulated wire interwound with the cold end of L4. One end of the antenna coil is grounded and the other goes to an insulated jack on the front panel. The antenna is 7 1/2 feet of wire.

(Continued on page 78)

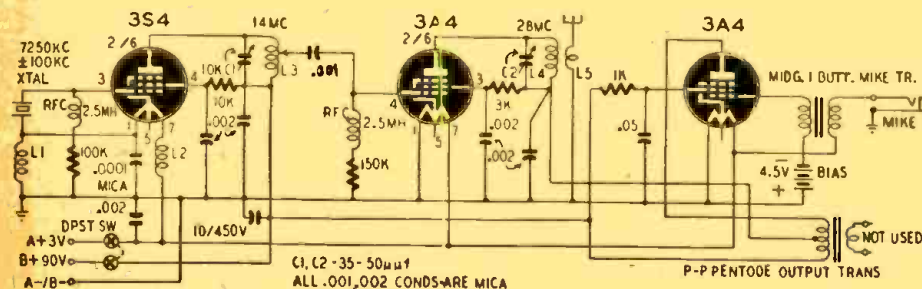

The sailplane transmitter uses three dry-cell tubes—oscillator, amplifier and modulator.

RADIOMEN!
GET THIS
Brand New! **Valuable Book**
OF "150 NEW RADIO DIAGRAMS EXPLAINED"
FREE

10 to 1 Satisfaction GUARANTEE

"I personally guarantee that at the end of 1 year from date of receipt, my Applied Practical Radio set will have earned for you at least 10 times its cost, or you may return it and I'll return every cent you paid."

B. W. Cooke, Pres.



Here's a sensational "get acquainted" offer! This big, new book, "150 New Radio Diagrams Explained" is yours, absolutely FREE! It contains circuits and data on the latest Radio and Television sets. Easy-to-read, 8 1/2 x 11" size, with full instructions on how to read and use diagrams. Belongs in every radioman's kit.

HOW TO GET YOUR FREE BOOK

You get this book Free just for looking over—without cost or obligation—the sensational new 5-volume Coyne set "APPLIED PRACTICAL RADIO." It's just off the press. Here's everything you want to know about radio, from basic principles to up-to-the-minute Television and FM! PA, shortwave, aviation-auto radio, multibands, tele-transmission testing instruments and trouble-shooting short-cuts, phototubes, etc., all clearly explained. Shows how to construct, install, service all types of apparatus. Step-by-step photos break equipment down before your eyes! Newest testing methods. Hundreds of subjects, over 1500 pages, almost 1000 illustrations, diagrams. Written for home training and field reference—so complete, so up-to-date and practical that every man interested in radio should see it.

SEND NO MONEY You can see how much your future, without cost or obligation. I'll send "APPLIED PRACTICAL RADIO" postpaid, for you to look over for 7 days FREE—and with it, the Radio and Television Diagrams book as an outright Gift! This book is yours to keep free whether or not you decide to keep the 5-Volume Set! In 7 days, either return the 5-Book Set and owe nothing or pay \$3 then and \$8 a month until \$16.75 is paid. Or you can save \$1.75 by paying \$15.00 cash price.

Use Coupon Now!

YOU ARE NOT BUYING THE 5-VOLUME SET WHEN YOU SEND THIS COUPON. You are merely asking to see the books free for 7 days. Free Book Offer is limited—so mail coupon today.



FREE BOOK COUPON

B. W. Cooke, Pres., Coyne Electrical & Radio School
 500 S. Paulina St., Dept. A8-T1, Chicago 12, Ill.

Send me the NEW 5-Volume Coyne Set, "APPLIED PRACTICAL RADIO" for 7 days FREE examination per your offer. Also send "150 New Radio Diagrams Explained" as a FREE gift.

NAME AGE.....
 ADDRESS
 TOWN ZONE..... STATE.....

Now Available! 3 HOURS OF CONTINUOUS PLAY WITH THE **MAGNETAPE* RECORDER!**



Now — record and play back on this amazing instrument any sound that can be heard, and many that cannot — from a concert hall symphony to the beat of your heart. Simple interchangeable capstans provide a choice of three tape speeds for high fidelity, medium fidelity, or up to 8 hour voice recording. The ideal recorder and playback unit for home, office, industry, and broadcast station.

Other standard and portable models of shorter playing duration also available. Write today for our free illustrated catalog featuring our complete series of Magnetape Recorders and accessory equipment.

Send 25c. in stamps or coin for A.C. Shaney's new booklet, "Elements of Magnetic Tape Recording — and 999 Applications." *Trademark

AMPLIFIER CORP. of AMERICA

EASY TO LEARN CODE

It is easy to learn or increase speed with an Instructograph Code Teacher. Affords the quickest and most practical method yet developed. For beginners or advanced students. Available tapes from beginner's alphabet to typical messages on all subjects. Speed range 5 to 40 WPM. Always ready—no QRM.

ENDORSED BY THOUSANDS!

The Instructograph Code Teacher literally takes the place of an operator-instructor and enables anyone to learn and master code without further assistance. Thousands of successful operators have "acquired the code" with the Instructograph System. Write today for convenient rental and purchase plans.



INSTRUCTOGRAPH COMPANY

4701 Sheridan Rd., Dept. RC, Chicago 40, Ill.

MIRACLE KIT VALUES!



PHONO OSCILLATOR 2-TUBE KIT
Hi-gain with microphone jack and all parts including Tubes \$2.95
10 WATT 4 TUBE HI-GAIN 6L6 AMPLIFIER KIT
Separately controlled Mike and Phono Inputs. All parts including drilled chassis, hardware, solder, circuit diagram, info., etc. Less Tubes \$6.95

UNIVERSAL TROUBLE SHOOTER KIT
Locates every service trouble. All parts including case, test leads, plus 2 1/4" x 6" x 3" \$3.95
PHONO-AMPLIFIER KITS—ALL PARTS INCL. TUBES
3 Tube Kit \$4.25 2 Tube Kit \$2.95
Pwr trans. 1500v C.T., 150ma, 6.3v 2.5a, 6.3v 1.6a, 3v 3a; 115v 50-60 cyc. pri., \$5.95 ea.
Fil trans. 6.3v 8a, 7.000v insul. 115v, 50-60 cyc. pri. \$2.29 ea.

Write for lists of bargains in Radio and Electronic parts. Also free data, circuits designed by **ROBT. G. HERZOG.**

Universal/General Corp.
365 Canal St., New York 13 (Dept. C.R) Walker 5-9642

FLASH THAT VOLTAGE

Turn that knob. Extinguish the neon glow. Instantly read voltage of d.c. MINI-VOLT model 400B measures 65 to 660 V. AC. Also DC. Tells AC or DC. Virtually burn-out proof. Guaranteed for 10,000 hours. 12" test leads. A "must" in electrical and radio work. At dealers or postpaid \$2.50. (C.O.D. 25c extra).

INDUSTRIAL DEVICES, INC., EDGEWATER 3, N. J.

Make Your Own RECORDS
with **RISCO 3-way Home Recorder**

"Snapshots in Sound"

Over 10 minutes recording on a 10" record at dual speed—4 1/2 min. at single speed.

- High fidelity record player
- Uses professional recorder
- An auxiliary P.A. amplifier

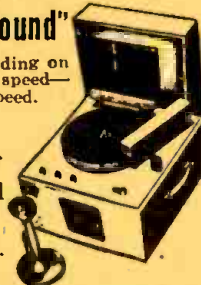

Ready to operate with 6" spk. crystal mike. Ideal for music lessons, parties, your child's cute sayings— **\$49.50**

PORTABLE CASE COMPLETE DETAILS \$5 EXTRA FOR DUAL SPEED

40% OFF ON RECORDISC RECORDING BLANKS 25% on C.O.D. Orders—Order From This Ad

FREE CATALOG RC IMMEDIATE DELIVERY

Come and Visit Our Sound Studio

RISCO ELECTRONICS
WHOLESALE DISTRIBUTORS
25 West Broadway, N. Y. 7, N. Y.

STAHL'S ★ STAR ★ STUDDED ★ SPECIAL ★



5 inch Cathode Ray, Type 5BP1 tubes. In their original cartons; Brand New. At this price every scope owner should buy a few, and keep in reserve. How can you go **\$1.95** wrong for only

Prompt Delivery—Write Dept. RC-6 25% deposit required on C.O.D. order Shipped F.O.B. New York. Min. Order \$2.00

MICHAEL STAHL, INC.

39 VESEY ST. Tel. WOrth 4-2882-3-4 New York 7, N. Y.

Get Started in Radio



10 "HOW-TO-DO-IT" BOOKS
Get a solid foundation in radio by means of these 10c timely text books. Each clearly written, profusely illustrated, contains over 15,000 words. You'll be amazed at the wealth of information packed into these handy books. Excellent for reference—ideal for technical library. Your money back if not satisfied.

5 BOOKS for 50c
10 BOOKS for \$1.00
Sent to You Postpaid

- No. 1—How To Make Four Doerle Short Wave Sets
- No. 2—How To Make The Most Popular All-Wave 1 and 2 Tube Receivers
- No. 3—Alternating Current for Beginners
- No. 4—All About Aerials
- No. 5—Beginners' Radio Dictionary (Leading Terms)
- No. 6—How To Have Fun With Radio
- No. 7—How To Read Radio Diagrams
- No. 8—Radio for Beginners
- No. 9—Simple Electrical Experiments
- No. 10—Television

Remit by check or money order—register letter if you send cash or stamps.

RADIO PUBLICATIONS

25A West B'way, New York (7)

A SAILPLANE TRANSMITTER
(Continued from page 77)

A midget 200-ohm microphone transformer is mounted below the chassis at the audio-frequency end of the transmitter. The microphone jack is on the front panel. A small 4 1/2-volt flashlight battery, or three penlight cells connected in series, furnish the bias for the modulator tube. The primary of a midget push-pull pentode output transformer is used for modulation, and is connected as a 2-to-1 autotransformer. Better results were obtained with this arrangement than with the B-supply connected at the center tap and a 3A4 plate circuit at each end of the winding.

The d.p.s.t. toggle switch shown in the diagram was removed from this transmitter when it was installed in the sailplane, because the transmitter was mounted in the turtleback, well aft of the pilot. The toggle switch was located near the battery case and spring-loaded to off position. A cord was run to the cockpit through a series of eyelets, to provide pull-to-talk operation.

The 7-mc crystal is mounted outside the case to facilitate changing crystals. The transmitter chassis and cover are made of 1/32-inch semihard aluminum, and the transmitter is completely enclosed when the wrap-around cover is placed over the top, back, and bottom of the chassis and secured with screws.

The front panel and two vertical sides of the transmitter chassis are bent out of one piece of aluminum 3 1/2 inches high and 13 1/4 inches long. The sides are 3 inches deep and the front panel 7 1/4 inches wide. Another piece of aluminum 4 by 8 inches, with all edges bent down 1/2 inch, forms the horizontal portion of the chassis, and, after bending, measures 7 x 3 inches. It is fastened to the front and sides by metal screws or small bolts. The wrap-around cover which



Top view of chassis shows tubes and battery.

forms the top, back, and bottom of the case, is made from an 8 x 10 1/2-inch piece of 1/32-inch aluminum.

The placement of parts is not critical because of the low power. In the original transmitter, a special effort was made to construct the r.f. portion of the transmitter in the smallest possible space to gain experience in miniature construction. An eyebrow tweezer was found to be much superior to long-nosed pliers in small confined spaces.

Use caution in insulating the variable condensers from the front panel, because they carry the full plate voltage of the transmitter. The r.f. coils are mounted directly on the condenser terminals. This is made possible by cutting

RADIO-CRAFT for

a 3 1/2 x 1 1/2-inch opening in the horizontal portion of the chassis, immediately above the variable condensers.

Batteries are two 45-volt Mininax's for B-supply. Two 1 1/2-volt batteries in series supply the 3 volts for the filaments.

Tuning up on 10

To tune the rig, remove all tubes except the 3S4 oscillator. Connect a 0-50-ma meter in the B-plus battery lead and tune the oscillator plate circuit for minimum current. The dip is usually about 1-2 mils. The 3A4 doubler is placed in its socket and plate circuit tuned to resonance. The oscillator plate circuit will need retuning at this time. It may be found that best results are obtained in exciting the 3A4 doubler by coupling the grid condenser about two turns down from the hot end of the tri-tet plate coil.

Insert the modulator tube and connect the antenna. Tune all circuits for minimum total B-current. The dip in the doubler plate will be about 4 mils without the antenna connected, and 1 mil loaded. Total current for the transmitter loaded is 40 to 45 mils. Do not attempt to use 135 volts as the 3A4 doubler will not modulate satisfactorily at this higher voltage.

This transmitter has worked out 2 miles across the city with a wire suspended in the radio shack. In the sailplane, with the antenna attached to the top of the fin, it has a range of 5 miles when the sailplane is on the ground. In flight, communication has been maintained with a ground crew in a car 65 miles away, and the transmitter was once heard 600 miles from Texas.

At the 1947 National Soaring Contest in Texas, nine flights were made, mostly over 100 miles, and one of 221 miles. On seven flights the ground crew was on hand at the time of landing. Many times it was possible to guide them into the



Bottom view of transmitter. Crystal at right.

pasture chosen for landing, and land directly toward the trailer, stopping only a few feet away and in position for immediate disassembly. The ground crew was my wife and W5KUB of Wichita Falls.

A number of radio amateurs were reached during the flights. They were usually within 50 miles line-of-sight. W5IZL of Electra, Texas, was especially cooperative. She left her receiver on our frequency at all times, and a short call would always find her ready to relay any message to contest headquarters.

Several sailplane pilots are licensed radio amateurs. Reception aloft is crystal clear, and, as a 10-meter transmitting and receiving location, a sailplane can best be described as *terrific*.

JUNE, 1948

Radio - Television - Electronic Parts & Equipment Specials

TELEVISION-CATHODE RAY HIGH VOLTAGE

2000 volt D.C. Power Supply

Why bother with bulky and dangerous 60 cycle supplies or expensive R.F. power supplies when you can purchase a complete 2000 volt D.C. unit (not a kit), ready to plug into the 110 volt A.C. power line. The ridiculously low price has been made possible by a fortunate purchase of high quality components. These units are brand new, completely tested and guaranteed.

Price \$7.95

4000-6000 VOLT TELEVISION SUPPLY

Similar to the unit above, but has a much higher D.C. output voltage suitable for use with the new 7" and 10" television tubes.

PRICE\$12.50

TELEVISION BOOSTER!

Increases signal strength to the television receiver 16-18Db. Rejects unwanted off-channel interference. Simply installed by connecting in series with antenna terminals of receiver, self-contained power supply.

Three models available

Model TVL—Channels 1 thru 6
Model TVH—Channels 7 thru 13
Model FM—88-108 Mc (FM Band)
Available in Walnut or Mahogany finish
Size 3" x 5" x 6"

Price \$26.95

SPECIAL!

Magnetic Recording Wire—1 1/2 hour spool of GE steel recording and playback wire priced for quick sale \$1.95

PHOTO-ELECTRIC TUBE

GE type P123 sensitive gas phototube—suitable for regular and invisible infra-red light. Has four prong socket and Calcium light sensitive element.

Price \$2.95

Cathode-ray tube Mask and Mounting bracket for 5" tubes. Excellent for use with 5" television sets or oscilloscope.

Price \$0.25

Chrome panel escutcheon for above—4 1/2" diameter opening—suitable for use with cathode-ray tubes or round dials.

Price \$0.25

TELEVISION PICTURE TUBE—9 inch electromagnetic type. This is the MW22-2 tube used by GE in their television sets. Can be used in other sets designed for electromagnetic deflection. Has standard 3 prong base.

Complete with instruction booklet..... \$13.95

A SCIENTIFICALLY DESIGNED PHONO SCRATCH FILTER

Resonated at approximately 4500 cycles effectively reducing objectionable needle scratch without altering the brilliancy of reproduction.

Contains a HI-Q SERIES resonated circuit. Tested by means of an audio oscillator and an oscilloscope to give 22 db. attenuation with very low signal loss. Attenuation may be regulated by means of a SPECIAL MINIATURE gain control.

EASY TO ATTACH

Just two wires to clip on. Compact. Price \$1.65

THREE TUBE PHONO AMPLIFIER

An assembled unit ready for installation using tone and volume control and six feet of rubber cord \$2.95

(Not Including Tubes)

With Complete Set of Tubes\$3.95

PHONO OSCILLATOR

Wireless phono oscillator transmits recording for crystal pick-ups or voice from carbon mikes through radio without wires. Can also be used as an intercomm by using P.M. speaker as mike. Price \$2.95

(excluding tubes)\$2.95

With Complete Set of Tubes\$3.95

SPECIAL! SPECIAL!

Mammoth assortment of radio and electronic parts, not less than TEN POUNDS of new transformers, chokes, condensers, resistors, switches, coils, wire, hardware, etc. A super-buy for experimenters, servicemen, and amateurs for only \$1.25

Satisfaction guaranteed on all merchandise. All prices F.O.B. New York City

WRITE FOR CATALOGUE

RADIO DEALERS SUPPLY CO.

135 Liberty St. New York, N. Y.

2 out of 3 Need It!

ESPEY
The Custom-Built Chassis



According to the RMA, over 18 million consoles were built before '44!

That's right! The newest are four years old, and there are more than 11 million of them that are ten years old. Of the 18 million owners, 51%, or over 9 million LIKE their cabinets—in spite of the fact that the vast majority of receivers are hopelessly obsolete, lacking such present-day essentials as FM.

Furthermore, over 90% of the console owners WANT FM, but less than 6% HAVE it. What a replacement market!

It was to fill this tremendous need that ESPEY designed its line of top-quality custom-built chassis, supplied complete and ready to operate in your customers' cabinets.

For further details about the ESPEY replacement chassis, and the opportunities in the replacement industry, we urge you to write today to Dept. C-6.



"Established—1928"

Do you need BINDING POSTS?

The XL PUSH POST with its Spring Action assures Constant Contact and Quick connection. Manufactured in All Aluminum Type M at 12c each, Aluminum Body, Bakelite Top Type B1 at 15c each. Types CP or NP, ALL BRASS—STAINLESS STEEL SPRING & PIN, PROVEN by 240 HR. SALT SPRAY TEST as NON CORROSIVE at 28c each. Manufacturers and Dealers Liberal Discounts

X. L. RADIO LABORATORIES
420 West Chicago Ave., Chicago 10, Ill.

All popular types of RADIO TUBES

at the lowest prices ever offered

70% OFF

at current list prices (25% deposit required on C.O.D. orders)

HARRIS SUPPLY CO.

1336 W. Chase Ave. Chicago 26, Illinois

WAR SURPLUS BARGAIN KIT



4 LAMPS ELECTRONIC PHOTO FLASH EQUIPMENT. THE FAMOUS "MODEL 1503" AIR-CRAFT FLASH UNIT.

This powerful high quality equipment was made for the U. S. Air Corps and will be shipped to you brand new in original boxes.

- **THE POWER SUPPLY** is built into a beautiful gray finished case, with all connectors, relay control, 2 condensers each 2000 Volts, 50 M.F.D. light output 110 Watt seconds, can be used with any 12 Watt battery as a professional studio flash equipment. The power pack alone is worth more than the price we are asking for the complete unit.
- **THE FOUR HIGH SPEED FLASH TUBES** are plastic sealed, unbreakable, 12 million peak lumens light output for more than 15,000 flashes.
- **IN ADDITION TO THIS WE SUPPLY:** aluminum reflectors, transformer, connectors, connecting cords, spare parts, diagram and instructions on how to use it for battery or on how to convert the unit for 110 Volt A.C.
- **IT IS THE BEST VALUE IN WAR SURPLUS MATERIAL.**

WHILE THEY LAST. **\$68.00**
PRICE complete

CINEX, INC., Dept. CR
165 WEST 46th ST. New York 19, N. Y.

WESTERN ELECTRIC

BRAND NEW—35 WATT

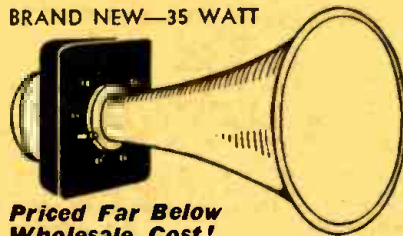

Priced Far Below Wholesale Cost!

- Full frequency response Driver Unit complete with projector.
- Excellent for Concessions, Ball Parks, Mobile, P.A. Work.
- Stock up now, Never again offered at this sensational price.
- Extra Heavy Duty Unit.

\$24.95
F.O.B. N.Y.C.



T. V. BOOSTER

• Clarifies pictures. Increases signal strength. Helps eliminate Ghosts and external picture interference. Simply hook up in series with Television Antenna. No Power supply required. Complete, self-sufficient, housed in an attractive black crackle finish metal case.

\$9.95

Attention **DEALERS—DISTRIBUTORS**
Send for our list of many other items, far below wholesale cost, on company letterhead.
All prices F.O.B. N.Y.C., 25% Deposit, Bal. C.O.D.

MANUEL KLEIN

74 CORTLANDT STREET
NEW YORK 7, NEW YORK

ECONOMY MULTIMETER

By HOMER L. DAVIDSON

THE small 0-1-ma meter used in this volt-ohmmeter is a 3-inch Triplet with an internal resistance of 27 ohms. There are 4 d.c. voltage ranges:



Octal socket and phone tip form the "switch."

from 0-10 volts, 0-100 volts, 0-500 volts, and the highest voltage range extends to 1,000 volts d.c. All the voltage-dropping resistors are plus or minus 5% accurate and were selected with an ohmmeter from a number to get ones actually accurate to within 1%.

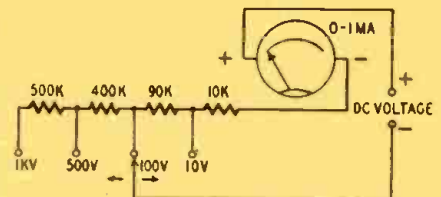

Fig. 1—Four voltage ranges are available.

All the different voltage ranges, ohms, and current circuits are broken down into separate circuits for clear understanding while discussing them: the d.c. voltage schematic circuit in Fig. 1; high and low ohms in Fig. 2; milliamperes schematic circuit in Fig. 3. Fig 4 shows the complete instrument.

The low-ohm scale is from 0-5,000 ohms. The low-ohm readings are well scattered over the entire range. The ohmmeter has proved very handy on this range to test for shorted i.f. transformer windings. The high ohmmeter range runs from 0-500,000 ohms and can be extended with an external battery. The only batteries used in this small meter were 3 small flashlight cells which total 4½ volts.

The current range was extended from 0 to 100 milliamperes by shunting a small resistance, R5, across the meter terminals so part of the current would be bypassed around the meter. This resistor, for a 27-ohm, 0-1 ma. meter, is 0.2727 ohm. The small resistor was wound with 1 foot of No. 34 enameled wire wound over a ½-watt carbon resistor. It is best to calibrate this resistor against an accurate milliammeter.

RADIO-CRAFT for

FREE RADIONIC CATALOG



CHOCK FULL OF BUYS!

- RADIO & TELEVISION PARTS - KITS
- PUBLIC ADDRESS INTER-COMMUNICATORS
- RECORDERS
- RECORD CHANGERS
- TEST INSTRUMENTS
- TUBES
- AMATEUR EQUIP'T
- CHANCELLOR RADIOS
- HARDWARE
- TECHNICAL BOOKS

A MUST for all
• Service Dealers
• Amateurs
• Experimenters
• Industrials
• Institutions
• Government Agencies

RADIONIC EQUIPMENT COMPANY
170 NASSAU ST., NEW YORK 7, N. Y.
Tribune Theatre Entrance
Tel. WOrth 2-0421 • Cable "CHANSLOR"

RADIONIC EQUIPMENT CO., Dept. 106
170 Nassau Street, New York 7, N. Y.

Send at once your free catalogs, supplements and bargain lists as published—listing products of leading manufacturers of radio-electronic parts and equipment.

NAME

P.O. BOX or STREET

TOWN STATE

WANTED:

WILL PAY \$1.00 PER COPY
for the following copies

OFFICIAL SHORT WAVE LISTENER MAGAZINE

• June-July 1935 • April-May 1936

Copies must be in good condition.

Radio-Craft, 25 West Broadway, New York 7, N. Y.

NOW-AFTER SEVEN YEARS 12B8 & 25B8 TUBES

Now Available

Composed of adapter, 1-6AT6 tube, 1-6BA6 tube, and 2 miniature sockets. The unit takes less space than the original 12B8 or 25B8 tube, and the adapter base will fit in the 12B8 or 25B8 socket perfectly. Nothing else to buy—unit is complete. Just plug in and it works!! Sold on money-back guarantee.

12B8 or 25B8 unit, complete: \$2.49 each
10 units for \$22.50.

Send 20% Dep., Bal. C.O.D.—Min. Order \$2.00.
Write for new free bargain catalog.

COMMERCIAL RADIO

36 Brattle Street Boston 8, Mass.

TUBE SPECIALS

- AC-DC five—50L8GT, 35Z5GT, 12SA7, K7, Q7GT...\$1.90
- Miniature five—50B5, 35W4, 12AT6, BA8, BE6... 1.90
- ★ TWO JUMBO ASSORTMENTS ★
- 40-35Z5, 20-50L8, 10 ea. 35L8, 12SA7, K7, Q7, 100 tubes.
- 40-35W4, 30-50B5, 10 ea. 12AT6, BA8, BE6, 100 tubes.
- Either of the above specials at only \$34.00
- Every tube new and perfect. Guaranteed 100%.
- Selenium rectifiers 100MA—ten for \$7.20
- Postage extra. 20% deposit on C.O.D. orders.
- Send for our new bargain list.

HALLMARK ELECTRONIC CORPORATION

392 Communipaw Ave. Jersey City 4, New Jersey

To eliminate a wafer gang switch for changing the different ranges a simple 8-prong octal socket was used. The male prong is a phone tip pushed into the end of a polystyrene rod. There are 6 ranges, and an a.c. voltage range was added later. This is optional with the constructor as plenty of space is still

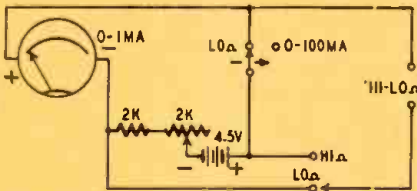

Fig. 2—The meter is in low-ohms position.

available in the small cabinet. Pin connections are shown in Fig. 5. Pin No. 5 was left over for the added a.c. voltage and the last pin left vacant for some future test position.

A s.p. 3-position switch (top of case) switches low ohms and milliamperes and has one open position for other ranges.

After the small volt-ohmmeter has been thoroughly inspected after wiring and soldering all connections, the ohmmeter range should be tested. First place the small tip in the high-ohm jack and also insert a pair of test leads in their respective phone jacks. Rotate the 5,000-ohm potentiometer clockwise, placing all

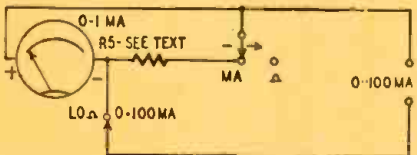

Fig. 3—The current range measures 0-11 ma.

its resistance in the circuit, and touch the 2 leads together. The meter movement should read toward full scale. Re-adjust the meter zero potentiometer, until the meter reads full scale. Now touch the 2 test leads to a low-ohm resistance and notice the meter movement. The meter should not read full scale, as resistance was placed in circuit. If at any time the zero adjusting potentiom-

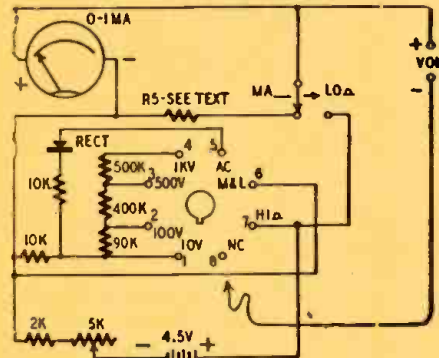

Fig. 4—Schematic of the complete instrument.

eter will not adjust the meter movement to full scale, the flashlight cells must be replaced. Full-scale reading should be checked periodically.

To test the low-ohm scale, the switch pin was shifted to the milliampere and low-ohm prong and the potentiometer adjusted so movement reads full scale. The milliampere-low-ohm switch is turned to low ohms. Touching the test

JUNE SPECIAL

- RESISTOR KITS \$1.45
100 assorted carbon and wire wound resistors... 1/2 to 10 watt. Wide range of values. All standard items.
- CONDENSER KITS \$1.75
50 assorted paper and mica condensers... all new... good value.

Wireless Phono Oscillator \$4.52
Operates as far as 100 ft. from radio and can be used with automatic record changer and players... complete with 2 tubes all wired and tested. Diagram.



Phono Pre-Amplifier \$4.95
This unit is for G. E. Reluctance type cartridge. Completely wired and tested. Supplied with diagram, and tube 6SC7.



Mike and Phono Amplifiers \$14.95
This unit sold complete with power transformer, 3 tubes and 3 controls... all wired and tested. Diagrams supplied.

RADIO PARTS

G.E. Reluctance Cartridge. List \$7.95.....	\$4.54
4" or 5" PM Speakers	1.15
6" PM Speaker	1.55
5" 450 ohm dynamic Spk. with 50L6 output....	1.95
Selenium Rectifiers—100 Ma Famous Make....	.69
1/2 meg. Volume Control and Sw. long shaft....	.35
One. Coil 155A715
8 ft. line cord13
Astatic Crystal Pickups	1.89
Astatic Crystal Cartridges L-70A, L-26A, L-40	1.59
Alliance Motor and Turntable	2.50

FAMOUS MAKE CONDENSERS

50x30 150V.	\$.45	25, 50V.	\$.29
20x20 150V.35	16, 450V.39
20x20 (10). 150V.39	400V. or 600V. Per 10	
(25)39	.01, .02, .05	\$.49
8x8, 450V.49	.001, .002, .00549
25, 25V.29	.159

All prices F.O.B. N.Y.C.—On C.O.D. 25% Dep.
THE ROSE COMPANY
88 West Broadway, Dept. (C) N.Y.7,N.Y.

prods together will send the meter indicator to zero. With this type of circuit the battery is in the circuit at all times



Fig. 5—Pin connections for range selector.

and must be switched off when not in use. This can be done with the milliampere-low-ohm switch which is in the off position at middle position. Do not leave this switch on in either position while checking d.c. voltages for the meter will burn out immediately. It is best to switch the test leads of any multimeter to a voltage position immediately after any resistance or current measurement. This will prevent many unhappy accidents. As shown on the meter face the left-hand (red) test jack is positive. Whenever polarity is switched, the 2 test leads are reversed. The a.c. voltage range was added some time after the meter was constructed. If the builder desires it, the data is included in Fig. 4. A half-wave miniature copper-oxide rectifier was used to rectify the a.c. voltage to be measured.

The parts and material needed for the meter are very small. The whole instrument can be wired in a few hours. The cabinet used for the original model measures only 4 x 5 1/2 inches.

Just off the Press!
1948 Radolek RADIO PROFIT GUIDE



NEW COMPLETE RADIO PROFIT GUIDE FREE

RADIO REPAIR PARTS • TOOLS
SOUND SYSTEMS • TUBES
PHONO EQUIPMENT & SUPPLIES
TEST INSTRUMENTS • ETC.

Big, new ENLARGED complete catalog showing thousands of Radio Bargains sent to you immediately. Helpful, money-saving buying information. Send coupon today!

BIG VALUES, LARGE STOCKS,
FAST, DEPENDABLE SERVICE.

FREE... SEND TODAY

RADOLEK CO., Dept. C-068
601 W. Randolph St., Chicago 6, Ill.
Please send your Free Profit Guide Catalog and regular Supplements.

Name

Address

City

SAVE AT RADOLEK

Prepare For A Good Job Now in

RADIO SOUND and TELEVISION



LEARN QUICKLY IN THE GREAT SHOPS OF
COYNE

Get ready for a better job, bigger pay NOW in Radio. Cash in with "All-around" knowledge of Radio—Sound—Television. Train on actual equipment not by "Home-study". You learn quickest at COYNE because it's a real SHOP course!

G. I. APPROVED...also Finance Plan for NON-VETERANS. Don't let lack of cash hold you back. Many earn while learning. FREE Employment Service to graduates. Get facts today!

SEND COUPON FOR FREE BOOK
Send at once for Big Free Book on Radio, Sound and Television, and facts about our Finance Plan.

MAIL THIS COUPON TODAY

B.W. COOKE, Pres.,
Coyne Electrical and Radio School
500 S. Paulina St., Dept. AS-2H, Chicago 12, Ill.

Please send Big FREE Book and complete details

NAME

STREET

CITY

TUBULAR ELECTROLYTICS

Fresh stock Fully guaranteed
20 mfd. 150 V. 10 for \$1.79
20-20 mfd. 150 V. 10 for 2.49
8 mfd. 450 V. 10 for 1.85

Postage extra. 25% deposit on COD.
Write for our free bargain lists featuring "AMERICA'S BEST BUYS"
POTTER RADIO CO.
1312-1314 McGee St. Kansas City 6, Mo.

Look!

Send for FREE BULLETIN

Sent you every month. It's crammed full of real buys. A post card with your name and address brings it to you. You can't afford to miss its bargains. Mail your card today.

VALUE and PRICE LEADERS THAT CANNOT BE MATCHED

VOLUME CONTROLS

Our own private brand—made by a nationally known manufacturer. The construction, standard shaft and bushing. Individually boxed in our colorful carton carrying the RSE quality seal of approval. Complete with switch, full range of sizes.

10 M ohms	100 M ohms	each	59c
15 M ohms	250 M ohms	per 10	\$5.50
25 M ohms	500 M ohms	ass'd.	
50 M ohms	1 Meg ohms		
2 Meg ohms			
500 M ohms Knurled Shaft			

500 M ohms less switch, 39c each, 100 for \$35.00

SELENIUM RECTIFIERS

these prices speak for themselves!

100 mil. size	59c
Regular List \$1.60	
200 mil. size	79c
Regular List \$2.25	

SAVE \$ ON FUSES

3AG and SFE Types. 52 to 93% Discount Limited Supply—Check Your Costs and Buy Now!

Type and Rating	3AG5 (Slow Blow)	\$1.19
3AG2	3AG10	\$2.40
SFE 4 Amp	SFE6	\$1.92
SFE 9 Amp	3AG10	\$1.68
SFE 14	3AG15	
SFE 20 Amp	Quantity Prices Not Assorted	

OZ4's at 73% OFF!

Until sold out—RSE offers 15000 new guaranteed OZ4 tubes. You know who made them—You can't go wrong at

ORDER INSTRUCTIONS

Minimum order—\$2.00. 25% deposit with order required for all C.O.D. shipments. Be sure to include sufficient postage—excess will be refunded. Orders received without postage will be shipped express collect. All prices F.O.B. Detroit.

RADIO SUPPLY & ENGINEERING CO., Inc.
125 SELDON AVE. DETROIT 1, MICH.

SIGNAL GENERATOR

only \$12⁹⁵



- 456 KC - 465 KC - 600 KC - 1400 KC
- COMPLETE WITH TUBES READY TO OPERATE
- COMPLETE CRACKLE-FINISH CABINET
- TWO OPEN CHANNELS FOR ADDITIONAL FREQS.
- INDIVIDUAL TRIMMERS FOR RECALIBRATION
- SHIELDED OUTPUT LEAD
- FULLY GUARANTEED—FULL INSTRUCTIONS

FM TUNER KIT \$295

One tube experimental FM tuner. Amazing performance. Complete with tube, punched chassis and full instructions.

PRE-AMPLIFIER for GE \$475

Reluctance pickup complete



WRITE FOR LITERATURE

CONSTANT ELECTRIC

112 CORNELIA ST. Blyn 21, N. Y.

OPPORTUNITY AD-LETS

Advertisements in this section cost 25c a word for each insertion. Name, address and initials must be included at the above rate. Cash should accompany all classified advertisements unless placed by an accredited advertising agency. No advertisement for less than ten words accepted. Ten percent discount six issues, twenty percent for twelve issues. Objectionable or misleading advertisements not accepted. Advertisements for July, 1948, issue must reach us not later than May 24, 1948. Radio-Craft • 25 W. B'way • New York 7, N. Y.

AMATEUR RADIO LICENSES. COMPLETE CODE and theory preparation for passing amateur radio examinations. Home study and resident courses. American Radio Institute, 101 West 63rd Street, New York City. See our ad on page 88.

RADIOS, RECORD PLAYERS, TUBES, PARTS. SEND for free bargain list. Hallmark, 594 Communipaw, Jersey City 4, New Jersey.

RUBBER STAMPS, ETC., FOR SALE. COOKSON, Box O-RC, Puxico, Missouri.

LANCASTER, ALLWINE & ROMMEL, 436 BOWEN Building, Washington 5, D.C. Registered Patent Attorneys. Practice before United States Patent Office. Validity and infringement investigations and opinions. Booklet and form "Evidence of Conception" forwarded upon request.

MAGAZINES (BACK DATED)—FOREIGN, DOMESTIC, art, books, booklets, subscriptions, pin-ups, etc. Catalog 10c (refundable). Cleverone's, 863 First Ave., New York 17, N. Y.

PHONOGRAPH RECORDS 20c. CATALOGUE PARAMOUNT, RQ-313 East Market, Wilkes-Barre, Penna.

WE REPAIR ALL TYPES OF ELECTRICAL INSTRUMENTS. Tube checkers and analyzers. Heston Instrument Co. (Electric Meter Laboratory), 140 Liberty Street, New York, N. Y. Telephone—BARclay 7-4239.

YOU CAN ACCURATELY ALIGN SUPERHETERODYNE receivers without signal generator. Complete instructions \$1. Moneyback guarantee. Chas. Gates, Pecos 2, Texas.

RADIOMEN, SERVICEMEN, BEGINNERS — MAKE more money, easily, quickly. \$250 weekly possible. We show you how. Information free. Merit Products, 216-32L 132nd Avenue, Springfield Gardens 13, New York.

BUILD YOUR OWN PRECISION VOLT-OHM-CAPACITY meter. Complete set of plans \$5.00. Bradshaw Instruments, 348 Livingston St., Brooklyn 17, N. Y.

ENGINEER, GRADUATE MECHANICAL, AUTOMOBILE-aircraft. Age 44, veteran. Knowledge English, French, German. Twenty years' experience. Industrial, railroad, road- & air-traffic field, public relations, radio. P. O. Box 273, G.P.O. New York 1.

WESTERN ELECTRIC CARRIER TELEPHONE AND Telegraph Equipment and Components. Filters, repeating coil, transformers, equalizers. Types CF1, CF2, H, C, and other carrier equipment. Telephone and telegraph repeaters. Box No. RC-A6, Radio-Craft, 25 West Broadway, New York 7, New York.

28 YEARS' EXPERIENCE RADIO REPAIRING AT your fingertips. I've perfected simple system you can follow step by step. No formulas or calculations. Cuts repair time to minimum. Total price \$2.00 postpaid or COD. Moneyback guarantee. Ross Radio, 14815-J Grand-river, Detroit 27, Michigan.

- ANSWERS TO QUIZ ON PAGE 61
- (a, c); 2. (a); 3. (b); 4. (c); 5. (b); 6. (all); 7. (b); 8. (c); 9. (b); 10. (a, c).

PREFERS SHORT WAVE

Dear Editor:

I have been following with great interest the arguments in RADIO-CRAFT on FM vs. short wave.

It is true that at this time FM has a very high plane of programs, but I remember when AM was the same way. Now listen to it!

To me, international short wave has proven that it can present good dramatic, musical, and public service features consistently. One merely has to tune in any daytime AM broadcast to find out what has driven me to short-wave programs. In my opinion, FM will become the same as AM.

I can get the best music over short wave and it is music that cannot be matched by our own ultra-commercial, top-heavy system.

JOHN R. GATES,
New London, Conn.

(How about the noise, interference, and heterodynes of the shortwave bands?—Editor)

TRAINED MEN NEEDED

Dear Editor:

Our experience has been that while thousands upon thousands of men have been trained in schools and the armed services, there is always a shortage of competent practical personnel when you want to do anything serious in a commercial way. For example, getting a good FM repairman or television installation and repairman is extremely difficult. Every real good one rapidly migrates into some venture where he can more adequately use his ability. He then attempts to get novices to work for him. Hence, there is a sad shortage of servicing technicians for the FM and television business.

The complexities of shooting trouble through involved circuits require experience and training beyond what the public has been educated to pay for. We are observing in television transmitting equipment that the maintenance man of such transmitting equipment is indeed difficult to train and expensive to keep. An ordinary camera chain maintenance man has to be far better trained and have far more basic ability than the master trouble shooter of an entire voice broadcasting station. Indeed, they are like the difference between the complexities of a giant airliner and the comparative simplicities of a cub plane. Radio, electronic and television arts move along in the laboratories at a tremendous speed. Technicians and engineers who do not keep up with these rapid improvements fail financially and move into other professions. The technical world belongs to the persistent and aggressive.

The more you can do to help show the widespread need for competence both on the part of the old and new technicians, the better. Further than that, there should be some discussion of the words, "engineer" and "technician." A camera maintenance technician has actually to know more engineering than many a competent voice radio engineer.

RADIO-CRAFT for

It is time that those of us who pioneer in these arts give attention to the meaning of these names. The engineer of 20 years ago in radio would not even be a competent technician today.

U. A. SANABRIA, PRESIDENT,
AMERICAN TELEVISION, INC.,
Chicago, Illinois

WANTS ESPERANTO TAUGHT

Dear Editor:

I have just read your editorial, "Radio in the Next War." I taught electronics at the Army Air Force Radio School at Truax Field, Madison, Wisconsin, for three years, so I think I have some understanding of the importance of radio in war. According to the Callup poll, 65% of the American people favor making the U.N. into "a more perfect union," and only some 13% are opposed.

A union of nations would be so strong that any country which did not belong would never dare to attack, and, I believe, would eventually join. Texas, for example, might have continued as an independent country, but it saw a great advantage in joining the Union.

In forming a federal union, the United States had one great advantage which the world does not now have—a common language. This is where radio can do a great work for world peace. Let radio back up its endorsement of Esperanto. One can learn to read Esperanto in one hour because it is in essence a code. In six months, with lessons of one hour a day, any person can learn to speak the language excellently.

If we want peace, we must do two jobs: make the U.N. a more perfect union, and adopt a common language.

GLENN R. TURNER,
Madison, Wisconsin

(The Editor of RADIO-CRAFT many years ago tried for many months over broadcast station WRNY, then in New York, and through one of his former radio magazines, to sell Esperanto to radio people. The effort was kept up for over a year but the response was so poor and the interest so low that it is felt an artificial language will probably never succeed on this planet.—Editor)

AFRAID TO ADMIT FAILURE

Dear Editor:

I agree that it is unfair to plant a defect in a radio. This procedure is not a true test of the serviceman's ability, but it may indicate the extent of his honesty. There is no harm in admitting that occasionally problems cannot be solved immediately or at all.

I'm an electrical engineer employed by a construction company. Despite my experience, there are times when problems that I cannot handle confront me. Rather than make the situation worse, I seek assistance, or permit someone with more experience than myself to take over.

Many radio servicemen, though, will take a set and "botch it up" rather than say to the customer, "I'm sorry, but I can't seem to find the defect."

DANIEL FEERST,
Elmhurst, L. I.

TECHNICAL KO's

OIL-FILLED CONDENSERS			TRANSMITTING MICAS		
.05 MFD	1000V	\$0.35	30.0	90VAC	\$1.40
.05	500V	.14	30.0	330VAC	3.75
.1	2500V	.75	.000025	2500V	.15
.1	7500V	1.65	.00005	2500V	.15
2x.1	7000V	4.10	.00005	3000V	.13
.12	15000V	7.95	.00005	5000V	.85
.25	1000V	.35	.000067	2500V	.20
.25	4000V	2.15	.00007	2500V	.20
.25	6000V	3.75	.00025	2500V	.25
10x.25	600V	1.05	.00025	5000V	.85
.5	800V	.28	.0005	2500V	.25
.5	1000V	.40	.00072	5000V	.85
.5	2000V	.75	.0008	5000V	.85
.75	400V	.30	.0001	2500V	.25
.85	600V	.35	.0011	5000V	.85
1.0	1000V	.45	.002	1200V	.20
2.0	200V	.20	.002	3000V	.65
2.0	600V	.40	.0025	1200V	.15
2.0	1000V	.60	.0025	2000V	.25
4.0	600V	.60	.003	2500V	.30
4.0	1000V	1.00	.003	3000V	.65
5.0	220VAC	.55	.004	2500V	.35
6.0	600V	.70	.005	1000V.T.V.	.15
6.0	1000V	1.45	.005	3000V	.65
8.0	600V	.85	.006	2000V	.35
8.0	1000V	1.75	.008	1200V	.15
10.0	600V	1.00	.01	1200V.T.V.	.15

TUBES-CHOKE

6V6 METAL	\$0.89
12K8 METAL29
100MA-10H, 250 OHM	1.59
POTS: 20K-50K-100K	\$0.19
POTS: DUAL-1 MEG, 1/2 MEG, "250K-50K"30
SHIELDED WIRE #22	50 Ft. for	.65
RESISTOR KIT ASSORTED 1/2 & 1W	100 for	1.49
BATHTUB KIT 3x.1, .5, .05, ETC.	10 for	.58
CONDENSER KIT .01-.00001	100 for	2.99
MICAS .01, .002, .005, ETC. All Values		.08
.01 150V PAPER (MIDGET)	60 for	1.00
.01 600V PAPER	8 for	1.00

\$2.00 min. order F.O.B., N.Y.C. Add postage 50% deposit, balance C.O.D. with all orders. Manufacturers inquiries invited. Send for Flyer. Prices are subject to change without notice.

TECHNICAL RADIO PARTS CO.

265 Greenwich St. Dept. RC-1 N.Y. 7, N.Y.

TRADIO-ETTE



Here's one of the finest business opportunities in years. You can cash in on the fact that people like radio with their meals. That's why Tradio-ette—a small, compact coin-operated radio designed for restaurant and tavern booths—has become so nationally popular. Plays 15 minutes for 10c.

Small Investment Thousands of high-yield locations are available if you get in on the ground floor. Only a small investment needed to operate this lucrative full or part time business. Tradio is the nation's leading manufacturer of coin-operated radios.

For Complete Details . . .
Contact Us Today
WRITE Dept. U-6

TRADIO, Inc. ASBURY PARK NEW JERSEY

NEW INDOOR TELEVISION ANTENNA

ELIMINATES REFLECTIONS

- VISIBEAM -



PAT. APP.

For Use With All Television Receivers. Ideal for Hotels and Apartments. Compact—12" Diameter—Table Lamp Size. Made of Polished Lucite. Tunes to all channels.

THERE IS NO LANDLORD OR INSTALLATION PROBLEM WHERE THE VISIBEAM IS USED.

RETAILS AT **\$16⁹⁵**

At Your Dealers
MFG. by **BURNETT SERVICE CO.**
178 W. 168 ST., NEW YORK 52, N. Y.



Exclusive Penna. Ave. and Boardwalk

HOTEL STRAND

Atlantic City's Hotel of Distinction.

The Ideal Hotel for Rest and Relaxation • Beautiful Rooms • Salt Water Baths • Glass inclosed Sun Porches • Open Sun Decks atop • Delightful Cuisine • Garage on premises • Open All Year.

FIESTA GRILL FAMOUS FOR FINE FOODS

TOM ALLEN'S RADIO SPECIALS

Many Others Not Listed

RADIO ALTIMETER

Transmitter Receiver RT7/APN1—complete with 14 tubes; 418 to 456 meg. 27v dynamotor. Certified by CAA: cost \$21.95 Govt., \$2,000. Bargain **\$11.95**

BC-456B

MODULATOR UNIT, new complete with tubes, 3 relays; parts worth more than our low price of **\$3.95**

RADIO RECEIVER BC-1023A

Ultra High Frequency, covering 62 to 80Mc range. An extremely sensitive relay, works on 4/10 of mil. Complete with 4 tubes; 12SH7, 6SQ7, 6SC7, 6U6TG. Brand New **\$3.95**
Shock Mts. and instruction book included.

BC-733D

SUPERHET RECEIVER—10 tubes, 6 xtals, 6 selector relays; operates on any one of the 6 xtal controlled frequencies; from 108.3 to 110.3Mc. Can be easily converted to 2 meter ham or mobile telephone band. Gives both visual or aural indications of position of aircraft in respect to the runway. New **\$10.95**

AIRCRAFT RECEIVER

R5/ARN-7 15 tube set. 4 bands 100-1750 KC. Easily converted to Home Broadcast. 115v-400 cycle Power Supply Shock Mts. and schematic included. Less Tubes **\$9.35**
15 tubes for above **\$10.50**

TUBE KITS

Comes in complete sets
Each set **\$10.50**
SCR 269-BC 433
R5A/ARN 7-R5/ARN7

TUBES

65C7	\$1.10	6B8	88c
6N7	\$1.13	6F6	60c
6K7	75c	2051	80c
6L7	\$1.00	5Z4	90c
6J5	68c		

FIELD TELEPHONE

WE and Kellogg
EE 3-4-5 and 8 with ringer and generator. French type handset and carrying case. Guaranteed perfect working order... **\$9.95**

RECEIVERS

AN/CRW2 High Frequency
6 Tubes—2 Sensitive Relays. **\$6.50**
BRAND NEW
AN/CRW2A High Frequency
5 Tubes—3 Sensitive Relays. **6.50**
BRAND NEW
Both complete with tubes and dynamotor. Used for controlling purposes.

ANTENNA WIRE

On reel, 300 ft. braided copper. BRAND NEW, Each. **\$2.50**

Write for Quantity Discounts

Prompt Delivery—Write Dept. RC6
25% Deposit Required on C.O.D. Orders
Shipped F.O.B. New York Minimum Order \$2.00

T. ALLEN CO., INC.
564 Atlantic Ave. Brooklyn 17
Tel. TRIangle 5-8241 New York

ADDED VALUE AT NO EXTRA COST

another RCP first



FM Signal Generator Model 720A

9.1 - 10.7 - 88 - 108 mc.

only **\$19.95**

R. C. P. scores another first with this new low-cost accurate, pocket size FM Signal Generator! Start cashing in now on the rich FM business—not by investing 100 dollars—or even 50—but with only \$19.95. Order this extra profit-building FM Signal Generator from your R. C. P. jobber today. Only \$19.95 for an accurate instrument that permits you to align and service FM receivers.

- Complete with tubes ready to operate
- Pocket size 3" x 6" x 2 1/2"
- Completely shielded and isolated from line
- Calibration, accurate within 1% for fixed frequencies of 9.1, 10.7, 88, and 108 mc.
- Individual trimmers for recalibration
- Equipped with shielded output lead

Many other outstanding features, too. If your local jobber can't supply your needs, use convenient coupon below.

ALSO MODEL 710 FOR AM—Small—compact—accurate. It's the ideal job for "on-the-spot" aligning, trouble-shooting, estimating and repairs. Fixed frequencies: 1500 and 550 kc; 456 and 465 kc. Safe for AC and DC operation. Pocket size 3" x 6" x 2 1/2". Complete with tubes, output cable, etc. Ready to operate at the remarkably low price of \$17.95!

Send for R. C. P.'s complete new catalog of economy-priced, quality-built precision instruments. Before you buy any instrument—see R. C. P. first! It's best for every test.

RADIO CITY PRODUCTS CO., INC.

152 West 25th Street, New York 1, N. Y.

RADIO CITY PRODUCTS COMPANY, INC.
Dept. RC6, 152 W. 25th St., New York 1, N. Y.
GENTLEMEN:

Please rush the following information to me:
() Descriptive bulletin on Model 720A and 710.
() Catalog No. 129 of complete R. C. P. line.
() Name and address of nearest R. C. P. jobber.

Name
Address
City..... Zone..... State.....

COUPON-OF-THE-MONTH

TUBES—STD. BRAND 35ZSGT or 35V4 10 for \$3.90
TUBES—STD. BRAND 12SQ7 or 12AT6 10 for 4.90
TUBES—STD. BRAND 50L6GT or 50B5 10 for 5.90
SAPPHIRE PHONO NEEDLES (List \$2.50) 10 for 6.80
STD. BRAND Vol. Controls—5 Meg. W.S.W. 10 for 4.40
STD. BRAND—40-40 MFD 180V 10 for 5.40
BY PASS CONDENSERS—.005 or .01 MFD
600V 100 for 6.90
• Combination Kit—All Above Items—Only \$37.50

WITH THIS COUPON—ORDER AT ONCE

• RADIOS—4 tube Superhet. (Nat. Known) 8.95
• RADIOS—5 tube Superhet. (Nat. Known) 13.95

Write for Monthly Coupons and Bulletin

RADIO DISTRIBUTING CO. PASADENA 18, CAL.

POLICE CONVERTERS FOR CAR RADIOS

Can be attached to any car radio. Does not affect reception on standard broadcast band. MODEL 100-B with fixed condensers, covers 1600 to 2600 kilocycles. Has one tube
List price \$19.95
Model 800-B Super sensitive. Covers 1500 to 3500 kilocycles. Has two-tubes, Exceptional distance range.
List price \$22.95

Jobbers and Dealers wanted.

Write for folder

ABC RADIO LABORATORIES
3334 N. New Jersey St. Indianapolis, Ind.

SERVICE CHARGES TOO LOW

Dear Editor:

I am a radio technician, and I have also worked for a wholesale radio parts house. I've spoken to well over 200 servicemen and found that their problems are all about the same.

The radio technician's main problem is not overcharging, but how to get a decent fee for his services. People seem to think that anybody in the radio repair business is working just to get experience.

I think that the radio repair business is sadly in need of some kind of organization so that servicemen can get together on fees that are fair to customers and themselves.

Manufacturers and jobbers should help out with a program to tell the public that radio servicing is a business, not a hobby, and requires an experienced serviceman plus expensive equipment.

WILLIAM A. GREEN,
Farmington, Mo.

SUGGESTS RADIO GUILD

Dear Editor:

I believe there should be a National Radio Service Guild with local chapters. All members would pay an annual fee. Servicemen seeking membership in the guild would be required to pass an examination, critical enough to distinguish him as a reliable and competent serviceman. After he passes the examination, he would be allowed to advertise his membership in the guild.

As much of the dues received as possible would go into advertising to inform the public that guild members are tops in their profession and honest in their charges.

In case of any dispute, the customer would submit his complaint to the guild which would appoint a board of members to investigate the complaint. If the serviceman is found to be at fault, he would be given an opportunity either to rectify the error or be suspended from the guild.

This system would show the honesty and progressiveness of the industry.

JOHN W. RITENOUR,
Norfolk, Virginia

BRITISH REPAIR PROBLEMS

Dear Editor:

I think radio servicing is harder here in England than in the United States. Only in one case in a hundred is a set only a year or so old. More often, it is at least 10 years old. In fact, the average age is about 12 to 15 years.

The main snags are conversions, for example, 6A7 to 6A8, 42 to 6F6. These are normal conversions, but there are so many more of other types that a service bill is often about \$15. No wonder people complain!

Here the dud serviceman is in his element and the reputable repairman has the task of reserving his job, correcting bad conversions, and resoldering cold joints. And in the end, the customer blows up at the large bill, and will not let the serviceman explain.

N. E. BAYLISS,
Birmingham, England

RADIO-CRAFT for

AMAZING—NEW SILVER CONDUCTING PAINT

Use the printed circuit technique to increase the efficiency of electronic circuits while greatly decreasing the physical dimensions of your radio sets. (Pure silver conductors make this possible). This marvelous advance in radio construction was developed during World War II and is now available to you.

See April 1948 issue of RADIO-CRAFT for transmitter measuring 2" x 3".
Introductory size bottle—only \$1.00 post-paid, or sent C.O.D. plus postage.
Regular 1 oz. bottle—now only \$3.00.
Special quotations on larger quantities.
Complete instructions with each bottle.
ORDER NOW—A must for every up to date experimenter

RADIONIC ASSOCIATES, Dept. RC-6
95 Nassau Street New York 7, N. Y.

RADIO TUBES

For immediate shipment

R.M.A. Guaranteed
Below Distributor Costs
Individually Sealed Cartons

Type	Price
6K6GT	.40
6K5GT	.46
6V6GT	.46
6SA7GT	.46
6SJ7GT	.46
6SK7GT	.46
6SQ7GT	.46
6X5GT	.40
12SA7GT	.46
12SQ7GT	.46
12SK7GT	.46
12SJ7GT	.46
35L6GT	.40
35Z5GT	.32
50L6GT	.46

10% DISCOUNT ON LOTS OF 50 OR MORE
25% Deposit Required—Balance C.O.D.
2% discount allowed on C.O.D.'s.

RAVAC ELECTRONICS CORP.
MAIL ORDER DIVISION
432—4th Avenue New York 16, N. Y.

FREE CATALOG

SIMPLY SEND YOUR NAME AND ADDRESS AND RECEIVE FREE OUR NEW BIG 1948 CATALOG. HUNDREDS OF RADIO PARTS VALUES.

AMERICAN SALES CO.
1811 W. 47TH ST., CHICAGO, ILL.

CLEARANCE ON TEST EQUIPMENT

Supremo 548-S Multimeters (5000 o.p.v.)	\$14.95
Hewlett-Packard Audio Oscillators (Reg. \$125)	69.95
Radio City FM Signal Generators (Model 720)	17.95
Meissner Signal Calibrators (Used) (Reg. \$77.17)	29.95
Readrite Panel Meters (0-200 Milliamperes)	.79
Triumph 5000 ohm per volt Multimeters (Like new)	14.95
Precision 929 Tube and Set Tester (Used) (Reg. \$82.54)	59.50

20% Deposit—Balance C.O.D.
Send for our latest bulletin.
REMER RADIO COMPANY
5904 S. PRINCETON CHICAGO 25, ILLINOIS

PREFERS ASSOCIATION

Dear Editor:

I agree that there are some chiselers in radio servicing, but I don't believe that licensing will eliminate the trouble. The state of California has a licensing law, but there are as many chiselers here as elsewhere.

A state radio association of servicemen would be better than any license. The association would investigate customers' complaints; and when they found an unfair serviceman, they could close him up and refuse to let him operate. In this way, servicemen would see that they are only hurting themselves when they try to put something over on the customer.

MARTIN ROTH,
Jackson, Calif.

CORRECTION

In the diagram of the *Hi-Fi 35-Watt Amplifier* on page 33 of the April issue, two .004- μ f capacitors are shown connected to pin No. 3 of the 6SN7. Only one should go to this pin—the other goes to pin No. 6.

The plate load resistors of the 6SN7 are shown as 5,000 ohms. They should be 50,000 ohms. The bottom ends of the 220,000-ohm resistor, the .008- μ f condenser and the 2-megohm bass control, in the grid circuit of the 6N7, should be connected to the upper end of the 50,000-ohm resistor from control to ground.

The headings L1, L2, etc., in the coil data table for the 1-10 Meter Receiver described on page 23 of the February 1948 issue are transposed. They should be L2, L1, L4 and L3 when reading from left to right.

The negative side of the filter condensers in the 3-Way Portable, page 42 of the February issue, should be connected to the fused side of the a.c. line. We thank Mr. Joseph Montgomery of West Newton, Penna., for calling this to our attention.

Radio Thirty-Five Years Ago

In Gernsback Publications

HUGO GERNSBACK

Founder

Modern Electrics	1908
Electrical Experimenter	1913
Radio News	1919
Science & Invention	1920
Radio-Craft	1929
Short-Wave Craft	1930
Wireless Association of America	1908

Some of the larger libraries in the country still have copies of ELECTRICAL EXPERIMENTER on file for interested readers.

From THE ELECTRICAL EXPERIMENTER, June 1914.

The "Electro" Detectaphone and Radio Amplifier by *H. Winfield Secor*
Wireless Receivers by *H. J. Lucas*
A High Amperage Key by *Alvin E. Spencer*

The Wireless Phone Record
A Simple "Quenched" Spark Gap
Wireless Joins two Universities
Artificial Radio Grounds
Radiophonic Apparatus
Radio Transmitting Problems

SENCO Stimulates Summer Buying With These Outstanding Savings!

Standard
Brand
AC PHONO
MOTOR AND
PICKUP

60 cycles, 115
volts, with Turn-
table. Complete

\$4.35



FREE
NEEDLE CUP
with motor and
pickup

LOOK AT THESE TUBE VALUES!

EVERY TUBE IN CARTON		R.M.A. GUARANTEED	
Type	Each	Type	Each
0Z4	69c	6U7G	35c
1A3	45c	6V5G	59c
1A5GT/G	59c	6V6GT/G	45c
1A7GT/G	55c	6X5GT/G	49c
1H5GT/G	59c	7A4	53c
1L4	49c	7A7	59c
1LH4	69c	7A8	58c
1LN5	69c	7B6	44c
1N5GT/G	59c	7F7	49c
1S5	59c	7N7	49c
1T4	69c	7X7	49c
1U5	36c	(XXFM)	44c
1V	45c	7Y4	44c
2A5	65c	12A6	35c
2A6	45c	12A8GT	39c
2A7	49c	12AT6	50c
2X2/879	35c	12BA6	50c
3A4	49c	12BE6	50c
3B4	55c	12J5GT	35c
5U4G	50c	12J7GT	45c
5W4GT/G	39c	12K7GT	45c
5X4G	39c	12K8Y	49c
5Y3G	42c	12Q7GT	45c
5Y3GT/G	40c	12SA7GT/G	40c
5Y4G	40c	12SF7	35c
5Z4	59c	12SJ7GT	55c
6A7	50c	12SK7GT/G	45c
6A8GT	49c	12SQ7GT/G	40c
6A C5	69c	12SR7	35c
6AC7/1852	65c	14A7	65c
6AG7/6AK7	89c	14B6	59c
6AK5	74c	24A	49c
6B7	55c	25L6GT/G	49c
6C4	29c	25Z5	49c
6CSGT	40c	25Z6GT/G	45c
6CSMG	89c	26	49c
6C6	45c	27	49c
6C8G	37c	32L7GT	52c
6D6	49c	35/51	49c
6F5	55c	35L6GT/G	45c
6F6GT	45c	35W4	43c
6H6GT/G	45c	36Y4	43c
6J5GT/G	45c	35Z3	44c
6J6	59c	35Z5GT/G	43c
6J7GT	42c	38	49c
6K6GT/G	45c	39/44	35c
6K7G	50c	41	49c
6K7GT/G	49c	47	49c
6K8G	55c	49	50c
6L6G	79c	50A5	60c
6Q7GT	47c	50B5	42c
6R7	55c	50L6GT	50c
6R7GT	59c	56	55c
6SA7	49c	57	45c
6SA7GT/G	44c	58	45c
687	49c	75	50c
687	49c	76	49c
68G7	44c	77	35c
68H7GT	40c	80	40c
68J7GT	44c	83V	79c
68K7GT/G	49c	85	49c
68L7GT	49c	99V	35c
68N7GT	49c	99X	35c
68Q7GT/G	44c	117Z6GT/G	89c
68D7	49c	182B	99c
6U6	49c	1231	39c
		1644	39c

POPULAR BRAND SPEAKERS	VOLUME CONTROLS
3 1/4" Cone 4" Sq. Frame	3" shaft tapped with switch.
4" P.M. Spkr. ea. \$1.19	250,000 ohms
5" P.M. Spkr. ea. 1.15	500,000 ohms
5 1/4" Cone 6" Sq. Frame	1 mek. ohms
6" P.M. Spkr. ea. 1.55	2 mek. ohms
8" P.M. Spkr. ea. 2.75	
12" P.M. Spkr. ea. 4.95	

39c each

829 PUSH PULL TWIN-TUBE Beam Power Amplifier Tube \$1.49 ea.

BRAND NEW WILLARD #27-2 2 VOLT STORAGE BATTERY AND 2 VOLT VIBRATOR

Used in General Electric model #530 charge A PACK portables. Suitable for all farm radio sets. Individually boxed.

\$2.69

BOTH FOR Rattery alone \$1.79 Vibrator alone 99c 6 Volt Auto Vibrators 4 Prong \$1.09 EACH

25% deposit on all orders, balance C.O.D.

F.O.B. New York

SENCO RADIO, Inc.

73 West Broadway, N. Y. 7, N. Y.
TELEPHONE BECKMAN 3-6498

RADIO SCHOOL DIRECTORY

PRACTICAL TECHNICAL TRAINING

SPECIALIZE in 6 months to 3 years

COURSES

- SERVICE**
6 to 12 Months
- Electricity
 - Welding
 - Refrigeration
 - Heating
- TECHNICIAN**
1 to 2 Years
- Electricity
 - Radio
 - Electronics
 - Refrigeration, Heating and Air Conditioning
- PROFESSIONAL**
3 Years
- Electrical Engineering
 - Bachelor of Science Degree
 - Major in Machinery or Electronics

Train in Electronics, Radio, Electricity for a substantial career in industry—or a business of your own. Prepare in one year to be a Technician—or in two additional years secure a Bachelor of Science Degree in Electrical Engineering with major in Electronics. More than 35,000 former students in industries the world over. 1,538 students now enrolled from 48 states and 13 overseas countries. Faculty of 72 specialists. Write for catalog and Personal Guidance Questionnaire—also mention course in which you are interested.

Terms start JULY, September, January



Dept. RC 648 North Broadway, Milwaukee, Wis.

THIS COUPON MAY PROVE TO BE THE KEY TO YOUR SUCCESS IN ELECTRONICS

MELVILLE RADIO INSTITUTE

The Progressive Radio School
Managed by Radio Men
Licensed by the N. Y. State Board of Education
RECOGNIZED BY INDUSTRY
APPROVED FOR VETERANS

CUT IT OUT! FILL IT OUT! MAIL IT OUT!—NOW!

MELVILLE RADIO INSTITUTE RC
Melville Bldg., 13 W. 46th St., N. Y. 19, N. Y.

Send me without obligation information about your intensive courses:

- Radio Technician
- Radio & Television Servicing
- Radio Communications
- Fundamental Radio Mathematics

My Name.....

Address.....

A CAREER WITH A FUTURE! TELEVISION

- SHOP WORK • SHOP TECHNIQUES • THEORY • FULLY EQUIPPED LABORATORIES
- RADIO SERVICE & REPAIR
 - F. M. & TELEVISION
 - TRANSMITTER COURSES
- Preparing for F. C. C. LICENSES

RADIO TECHNOLOGY
MORNING • AFTERNOON • EVENING CLASSES • MODERATE RATES • INSTALLMENTS
AVAILABLE UNDER G. I. BILL

DELEHANTY SCHOOL OF RADIO • ELECTRONICS • TELEVISION.
105 EAST 13th STREET, NEW YORK 3, N. Y. • DEPT. R
LICENSED BY STATE OF NEW YORK

RCA INSTITUTES, Inc.

Offer thorough training courses in all technical phases of **Radio and Television** WEEKLY RATES
VETERANS: RCA Institute is approved under G. I. Bill of Rights
For Free Catalog Write: Dept. RC-48

RCA INSTITUTES, Inc.
A Service of Radio Corporation of America
350 WEST 4TH STREET NEW YORK 14, N. Y.

RADIO OPPORTUNITIES

WRCI SPECIALIZED TRAINING—the “training-with-a-purpose”—DOES increase one’s earning power. For example, well-paying positions of responsibility now held by WRCI graduates include:

- BROADCAST ENGINEER-OPERATORS (AM & FM broadcast stations)
- FLIGHT RADIO OFFICERS (transoceanic airlines)
- RADIO-TELEVISION SERVICING TECHNICIANS
- RADIO SERVICE SHOP OWNERS
- COMMERCIAL RADIO OPERATORS (police, CAA, airlines)
- MERCHANT MARINE RADIO OFFICERS

With this proved record of successful training and placement, WRCI offers you, too, the best type of PRACTICAL training—under the supervision of radio and television specialists. Approved for veteran training. Non-veterans accepted. Send for free illustrated Booklet “F”—no obligation, of course.

WESTERN RADIO COMMUNICATIONS INSTITUTE
341 West 18 St., Los Angeles 15, California

LEARN RADIO!

IN ONLY 10 MONTHS
PREPARE FOR A GOOD JOB!
COMMERCIAL OPERATOR (CODE)
BROADCAST ENGINEER
RADIO SERVICEMAN

Television Servicing—15 Months

Veterans get \$130.00 Equipment
SEND FOR FREE LITERATURE
BALTIMORE TECHNICAL INSTITUTE
1425 Eutaw Place, Dept. C, Baltimore 17, Md.

SOUND RECORDING SCHOOL

A practical engineering course in Sound Fundamentals, Recording, and Sound Transmission measurements; in a laboratory containing transmission sets, oscillators, square wave generator and intermodulation analyzer, and other equipment.

Two complete recording studios assimilating broadcast, motion picture and commercial sound recording, under the direction of H. M. Tremaine.

HOLLYWOOD SOUND INSTITUTE, Inc.
1040-C No. Kenmore Hollywood 27, Calif.

WANTED:

Men and Women to Fill
TOP RADIO JOBS
in AM—FM—Television

If you are looking for a career with a future, why not join the hundreds of graduates from the Don Martin School of Radio arts now successfully employed in the radio industry. The demand is great for qualified radio personnel in AM-FM-Television. Train now to be an announcer, script writer, disk jockey, newscaster, or radio engineer. Complete day and night classes—the latest equipment. Free placement service. Approved for veterans. Write for free booklet.

Don Martin School of Radio Arts
1655 North Cherokee St. Hollywood 28, Calif.

RADIO ENGINEERING

FM—Television—Broadcast

Police Radio, Marine Radio, Radio Servicing, Aviation Radio and Ultra High mobile applications. Thorough training in all branches of Radio and Electronics. Modern laboratories and equipment. Old established school. Ample housing facilities. 7 acre campus. Small classes, enrollments limited. Our graduates are in demand. Write for catalog.

Approved for Veterans
VALPARAISO TECHNICAL INSTITUTE
Dept. C VALPARAISO, INDIANA

TELEVISION RADIO • FM

PRACTICAL TRAINING
LATEST EQUIPMENT
SMALL CLASSES
VISITORS WELCOME
Gotham Radio Institute
3534 BROADWAY (cor. 145th St.)
WA 6-0902 Approved for Veterans
IMMEDIATE ENROLLMENT

CORRESPONDENCE COURSES IN RADIO and ELECTRICAL ENGINEERING

ELECTRICAL ENGINEERING Get good grasp of wide electrical field. Prepare yourself at Low Cost, for secure future. Modern course. So simplified anyone can understand quickly.
RADIO ENGINEERING Extra fine course in radio, public address, photo-electric work. Trains you to be super-service man, real vacuum-tube technician. Servicemen needed badly. Diploma on completion. Many graduates earning big pay.
Send postcard for Free Copies of school catalog, full details, all about deferred payment plan, experimental kits, etc. **\$25** Course
Lincoln Engineering School, Box 931-C-112, Lincoln 2, Nebr.

RADIO COURSES

- RADIO OPERATING — CODE
 - RADIO SERVICING — ELECTRONICS
 - F. M. TELEVISION
 - REFRIGERATION SERVICING
- Personal Counseling Service for Veterans
Write for Catalog and Picture Brochure
Y.M.C.A. TRADE & TECHNICAL SCHOOLS
7 W. 64th Street New York City

CODE SENDING SPEED

Be a “key” man. Learn how to send and receive messages in code by telegraph and radio. Commerce needs thousands of men for jobs. Good pay, adventure, interesting work. Learn at home quickly through famous Candler System. Qualify for Amateur or Commercial License. Write for FREE BOOK.
CANDLER SYSTEM CO.
Dept. 3-G, Box 928, Denver 1, Colo., U.S.A.

RADIO

TECHNICIAN and RADIO SERVICE COURSES
FM and TELEVISION
AMERICAN RADIO INSTITUTE
101 West 63rd St., New York 23, New York
Approved Under GI Bill of Rights
Licensed by New York State

Hollywood Experts Help You **Make Good in RADIO-TELEVISION** at Home

Direct from Hollywood, nerve-center of broadcasting, Television, Radio and Sound activities, comes R-T-A’s time-proven and tested home training. Here at last—easy to learn, home instruction that quickly qualifies you for steady, good-pay jobs or your own Radio business. 10 big kits of radio parts given at no extra charge. Get full details at once! Send postal for FREE BOOK “How to Make Good in Radio-Television.” R-T-A APPROVED FOR VET. ERANS.
RADIO TRAINING ASS’N OF AMERICA, Dept. RCF
5620 Hollywood Blvd. Hollywood 28, Calif.

RADIO-CRAFT for

FM TRANSMISSION AND RECEPTION, by John F. Rider and Seymour D. Uslan. Published by John F. Rider, Inc. Paper or cloth covers, 5½ x 8¼ inches, 409 pages. Price, paper \$1.80, cloth \$2.70.

The basic principles of wide- and narrow-band FM transmission and reception, antennas, and operation and design of FM equipment are covered in this book.

The book is divided into two parts. The first covers theory of frequency and phase modulation, reactance tube modulators, a.f.c., frequency multiplication, and design characteristics of several commercial FM transmitters.

FM antennas, tuners, and receivers are discussed in the second part. Each stage in the FM receiver is compared to its equivalent in an AM set. Four types of FM detectors are discussed in detail, including comparison of all types.

MOST-OFTEN-NEEDED FM AND TELEVISION SERVICING INFORMATION (1947), Compiled by M. N. Beitman. Published by Supreme Publications. Flexible fiber covers 8½ x 11 inches, 192 pages. Price \$2.00.

Prepared in the style familiar to users of other books in the Most-Often-Needed Diagrams series, this manual contains servicing information on and diagrams of approximately 80 FM and television receivers made by 24 manufacturers.

The servicing information is much more detailed and complete than in a similar edition on AM receivers. In almost all instances the servicing information includes dial stringing diagrams, voltage and tube location charts, oscillographic patterns available at test points, and photographs of test patterns produced with the set in various stages of misadjustment.

HEARING AIDS, An Experimental Study in Design Objectives, by H. Davis, S. S. Stevens, R. H. Nichols, Jr., C. V. Hudgins, R. J. Marquis, G. E. Peterson and D. A. Ross. Published by Harvard University Press. Flexible fiber covers with plastic spiral binding, 6 x 9 inches, 197 pages. Price \$5.00.

An account of a very complete set of experiments conducted to discover what types of hearing aids are most suited for the average hard-of-hearing person, whether individuals would profit by specially-fitted equipment, and the effects of varying the apparatus design for the individual user.

This book has been referred to as

authoritative in much material written since its publication, and there is little doubt that it has had and will continue to have a powerful influence on hearing-aid design.

WHAT ELECTRONICS DOES, by Vip Zeluff and John Markus. Published by McGraw-Hill Book Co., Inc. Stiff cloth covers, 5¼ x 8¼ inches; 306 pages. Price \$3.00.

An interesting description of the numerous industrial applications of electronics, written for the general reader, this book gives a picture of the many wonders that electronics is performing today. Commercial uses explained include color matching, navigation for ships and planes, fault-finding in metals, paint spraying, cooking and defrosting, as well as many others.

WORLD RADIO HANDBOOK FOR LISTENERS, published and edited by O. Lund Johansen, Pilestraede 32, Copenhagen, Denmark. Heavy paper covers, 6½ x 8¼ inches, 96 pages. Price \$1.30.

This book is a serious attempt to compile an authentic list of all shortwave broadcast stations of the world. Divided into continents and countries, it gives locations, call signs and frequencies as well as condensed program schedules of shortwave stations. Included are the normal clock time of each country and announcements and interval signals of the chief broadcasters, also addresses of broadcast administrations or companies and names of leading personalities. The shortwave listener will appreciate these additional aids to identification and verification.

In addition to shortwave broadcasters, long- and medium-wave European stations are also listed.

TELEVISION ENCYCLOPEDIA, by Stanley Kempner. Fairchild Publishing Co. 5½ x 8 inches, 415 pages. Price \$6.50.

There are three main divisions in this work. The first, called "Milestones to Present-Day Television," is a 39-page chronological survey of the subject from 600 B.C. to 1947 A.D. The second, covering 92 pages, is a biographical encyclopedia of people who have contributed to the development of the art. Most of the rest of the book is devoted to a vocabulary of special television terms, chiefly technical but containing also a number of studio and commercial expressions.

A rather complete bibliography adds to the value of the book.

Here it is! JUST PUBLISHED

*The Practical Aspect
of the Future of Radio*

TELEVISION & F-M RECEIVER SERVICING

by

MILTON S. KIVER

Registered Professional Engineer

As every radio man knows, the limitless possibilities of radio in the fields of F-M and television broadcasting are no longer "just talk"—the future of radio has arrived! With more and more F-M and television sets on the market and in operation, no student or service man can afford to be without the wealth of up-to-the-minute information in this great new book.

Written by the author of *U.H.F. Simplified*, *F-M Simplified* and *Television Simplified*, this simple, well-organized text makes crystal clear all types of servicing problems. There are specific directions for installing television receivers, and for diagnosing, locating and repairing the common troubles of F-M or television receivers. In addition, complete alignment and servicing instructions are given at each point of a logical step-by-step procedure. These are summarized in separate chapters (one for television, one for F-M) so that explanations and instructions are fully coordinated.

The student or service man familiar with present-day A-M receivers easily understands every page of this book. Mathematics is kept to a minimum—just enough to enable the service man to compute properly the lengths of transmission lines and antennas. The book is profusely illustrated with photographs and schematic diagrams.

CONTENTS The Antenna System, Operation and Installation; Television Receiver Installation; Television Test Equipment; The Television Receiver, Operation and Servicing (4 chapters); Television Receiver Alignment; Trouble Shooting; Television Receivers; F-M Fundamentals; Commercial F-M Receiver Circuits; F-M Receiver Alignment; F-M Receiver Servicing.

**EXAMINE
THIS BRAND-NEW
BOOK FREE!**

MAIL THIS COUPON

D. Van Nostrand Company, Inc.
250 Fourth Avenue, New York 3, N. Y.

Please send me a copy of **TELEVISION and F-M RECEIVER SERVICING** for examination. Within 10 days I will return the book to you or send you \$3.25 plus a few cents postage.

Name

Address

City State

RC-June 1948

TELEVISION 1948!!

Train at an Institute that pioneered in TELEVISION TRAINING since 1938. Morning, Afternoon or Evening Sessions in laboratory and theoretical instruction, under guidance of experts, covering all phases of Radio, Frequency Modulation, Television, lead to opportunities in Industry, Broadcasting or own Business. Licensed by N. Y. State. *Approved for Veterans.*

ENROLL NOW FOR NEW CLASSES
Visit, Write or Phone

RADIO-TELEVISION INSTITUTE

480 Lexington Ave., N. Y. 17 (46th St.)
Plaza 3-4585 2 blocks from Grand Central



RADIO COURSES

Preparatory, Service, Broadcast, Television, Marine Operating, Aeronautical, Frequency Modulation, Radar.

Classes now forming for the summer term
June 1. Entrance exam. May 17.
Veterans. Literature.

COMMERCIAL RADIO INSTITUTE
(Founded 1920)
38 West Biddle Street, Baltimore 1, Md.

**Before you buy TELEVISION
See the DeWALD BT-100—**

*By far the FINEST we've
been able to discover
ANYWHERE*



**DeWALD BT-100 DIRECT VIEW
10" TELEVISION RECEIVER**

- 13 channels • 52 sq. in. picture
- 6 simple controls • Automatic Stabilizer
- Balanced Input Circuit

Fine Hardwood Veneer Walnut Cabinet 25½" x 19" x 15"

Net price to Dealers only.
Apply on Letterhead

LIST \$372.10



**DeWALD B-612
"WIRELESS F.M. TUNER"**

- Simply plug in and play
- AC/DC Operation • No wiring to Radio
- 5 tube and rectifier Superhet
- Balanced F.M. Detector Circuit
- Walnut Cabinet 11" x 6" x 7½"

LIST \$39.95



DeWALD B-504 "PERSONAL"

- AC/DC and Battery Operation
- 4 tubes and Selenium Rectifier
- Superhet circuit • 5"PM Alnico Speaker
- Only 4" x 8½" x 7½"

LIST \$27.95

Also available Battery
Operated

LIST \$19.95

**WE ALSO HAVE ALL THE NEW 1948
TEMPLE AND MINERVA LINES**

Dealers: Send for Catalog Discount Sheets

WARREN DISTRIBUTORS

3145B Washington Street, Jamaica Plain 30, Mass.

INDEX TO ADVERTISERS

ABC Radio Laboratory.....	84	Oelrich Publications.....	58
Tom Allen Corporation.....	84	Offenbach & Reimus.....	88
Allied Radio Corporation.....	5	Ohmlite Manufacturing Company.....	75
Almo Radio Company.....	60	Olson Radio Warehouse.....	55
American Sales Co.....	85	Opportunity Adlets.....	82
American Surplus Products.....	46		
Amperite Company.....	76	Potter Radio Company.....	81
Amplifier Corporation of America.....	75, 78, 88	Precision Apparatus Company.....	69
Audel Publishers.....	71	Progressive Electronics Co.....	50
Bell Telephone Labs.....	Inside Front Cover	Radio Apparatus.....	72
Boland and Boyce, Inc.....	16, 64	Radio City Products Co., Inc.....	84
Bonafide Radio Company.....	67	Radio-Craft.....	80
Brooks Radio Distributing Co.....	73	Radio-Craft Library Series.....	61
Buffalo Radio Supply.....	56, 57	Radio Dealers Supply Company.....	79
Burnett Service Company.....	83	Radio Development & Sales Co.....	88
Burstein-Applebee Co.....	75	Radio Distributing Company.....	80
Capitol Radio Engineering Institute.....	2	Radio Kits Company.....	71
Certified Television Laboratories.....	69	Radionic Associates.....	85
Cinex Corporation.....	80	Radionic Equipment Company.....	80
Cleveland Institute of Radio.....	15	Radio Publications.....	77
Collins Audio Products Co.....	67	Radio Research Products.....	74
Columbo Trading Co., Inc.....	71	Radio Supply & Engineering Co.....	82
Commercial Radio.....	80	Radio Wire Television, Inc.....	53
Communications Equipment Co.....	6	Radolek Company.....	81
Concord Radio Corporation.....	59	Ravac Company.....	85
Constant Electric.....	82	Remer Company.....	85
Coyne Electrical School.....	77, 81	Risco Electronics.....	78
DeForest's Training Institute.....	9		
Edmund Salvage Company.....	51		
Edwards FM Radio Corporation.....	58		
Electronic Corp. of America.....	49		
Espey Manufacturing Co., Inc.....	79		
Esse Radio Company.....	12, 13		
Federated Purchaser.....	69		
General Cement Manufacturing Co.....	69		
General Electronic Distributing Co.....	41		
General Test Equipment.....	69		
Green Radio Distributor.....	72		
Graylock Electronic Supply Co.....	75		
Hallicrafters Company.....	54		
Hallmark Electronic Corporation.....	80		
Harris Supply Company.....	79		
The Heath Company.....	48		
Hotel Strand.....	83		
Industrial Devices, Inc.....	98		
Illinois Condenser Co.....	73		
Instructograph Company.....	78		
International Resistance Co.....	Back Cover		
Joyce Radio Distributing Co.....	67		
Manuel Klein Ind. Corp.....	80		
Lafayette Radio.....	53		
Lear Radio, Inc.....	65		
Leads Radio Company.....	63		
Leotone Radio Corporation.....	59		
McGraw-Hill Book Company, Inc.....	54		
McMurdo Silver Company.....	4, 63		
P. R. Mallory & Company, Inc.....	Inside Back Cover		
Meter Master.....	74		
Metropolitan Electronic & Inst. Co.....	74		
Michael Stahl, Inc.....	78		
Mid-America Company.....	74		
Moss Electronic Distributing Co.....	43		
Murray Hill Books, Inc.....	73		
National Radio Institute.....	1		
National Schools.....	3		
Niagara Radio Supply Company.....	14, 52		

**RADIO SCHOOL DIRECTORY
(Pages 86-87)**

American Radio Institute.....	81
Baltimore Technical Institute.....	11
Candler System Company.....	85
Commercial Radio Institute.....	8
Delehanly Institute.....	7
Gotham Radio Institute.....	47
Hollywood Sound Institute, Inc.....	45
Lincoln Engineering School.....	83
Don Martin School of Radio Arts.....	83
Melville Radio Institute.....	78
Milwaukee School of Engineering.....	87
RCA Institutes.....	88
Radio Television Institute.....	54
Radio Training Association of America.....	76
Valparaiso Technical Institute.....	56
Western Radio Communications Institute.....	79
YMCA Trade & Technical Schools.....	

INVALUABLE!

**ELEMENTS OF
MAGNETIC TAPE
RECORDING
and 999
APPLICATIONS**



by **A. C. SHANEY**
Contains schematic diagrams
AVAILABLE FOR ONLY 25c

AMPLIFIER CORP. OF AMERICA
398-10 Broadway New York 13, N. Y.

FREE Catalog

• Radio, Television, Electronic Kits, Parts, etc. **LOWEST PRICES.** Also War Surplus Bargains. Get Your Copy Now.

OFFENBACH & REIMUS
372 ELLIS ST., SAN FRANCISCO 2, CAL.

20% SAVER

**All Merchandise Brand New
10% DISCOUNT ON ORDERS OVER
\$10—20% OVER \$25**

- 1/2 meg. vol. controls with switch, 3" shaft..... 39
 - G.E. Plate Circuit Relay—10M ohms—used with 50L6—Operates on 8Ma. S.P.D.T..... 95
 - OPERATES ON A BEAM OF LIGHT**
 - Photo-electric relay kit complete with all parts including tubes, relay, sensitivity, control and simple assembly instructions. ONLY \$5.95
 - Gruen 2½" meter -0-8ma. movement—scale marked 0-300..... 1.95
 - Weston #476—3½" meter—0-8v. a.c..... 3.95
 - Weston #507—0-1.5 amps. R.F.—2% accuracy to 65ma..... 4.25
 - Willard—6v. 3 cell—plexiglass case—miniature storage batteries—3½" x 1½" x 2¾"; shipped without electrolyte..... 1.95
 - Filter chokes—10Hy, @ 160 ma., 150 ohms resistance..... 1.25
 - Westinghouse chokes—4Hy @ 90ma., 300 ohms res..... 69
 - G.E. Selenium operated contactor #CR 2820—controls 6 circuits—operates on 115v. 60 cycles—4 x 9. 15 amp. contacts double break each circuit—G.E. catalog price \$25.00. YOUR COST...\$5.95
 - U.T.C. "S-8" Input Xmtr. line or mike to grid; dealer's price \$3.25; YOUR COST..... 1.25
 - Leach 6v D.C. relays—3 pole n.o. YOUR COST..... 1.25
 - Selenium Rectifiers: full wave—center tap—18V @ 2.5 amps..... 2.49
 - Rotary Switch with knob—A.H.E.H. 5 pole on and off; 10 amps @ 120v..... 59
 - Send us your name..... Get on our mailing list No COD. Includes postage..... Minimum order \$2.00
- RADIO DEVELOPMENT & SALES CO.**
323 ATLANTIC AVE. BROOKLYN, N. Y.



EQUALLY MATCHED

Split the reed assembly of a Mallory vibrator down the middle and the two halves will match each other so accurately that no scale made will register a significant difference.

This precise distribution of weight is a major factor in assuring accurate output, reliable operation and long life.

Mallory Vibrators Make

the Best Replacements

Such careful manufacturing makes Mallory vibrators free of bounce and chatter and dependable in starting. More of them are used in original equipment than all other makes combined. That's convincing proof

they are the best replacement vibrators for you to stock.

In addition to assured quality, Mallory offers the most complete line in the business. Mallory standardization permits 12 basic vibrators to meet 90% of your replacement requirements. But a complete line of 52 vibrators is available to meet virtually every vibrator need.



The Mallory Replacement Vibrator Guide is free. The Vibrator Data Book is \$1.00—from your distributor or by mail.

Mallory "2448" Vibrator Deal

This deal gives you a handsome storage and display cabinet for your stock of vibrators, together with a selection of vibrators and buffer capacitors that will answer 75% of your requirements.



You pay only the service man's net price of \$24.48 for the six vibrators and twelve buffer capacitors. There is no charge for the attractive, convenient cabinet. Your Mallory distributor has them in stock for immediate delivery.

MORE MALLORY VIBRATORS ARE IN USE THAN ALL OTHER MAKES COMBINED

P. R. MALLORY & CO., Inc.
MALLORY

CAPACITORS . . . CONTROLS . . . VIBRATORS . . .
SWITCHES . . . RESISTORS . . . RECTIFIERS . . .
"VIBRAPACK" POWER SUPPLIES . . . FILTERS

® Reg. U.S. Pat. Off.

APPROVED PRECISION PRODUCTS

P. R. MALLORY & CO., Inc., INDIANAPOLIS 6, INDIANA



This New IRC JUNIOR Control Cabinet Belongs on Your Bench

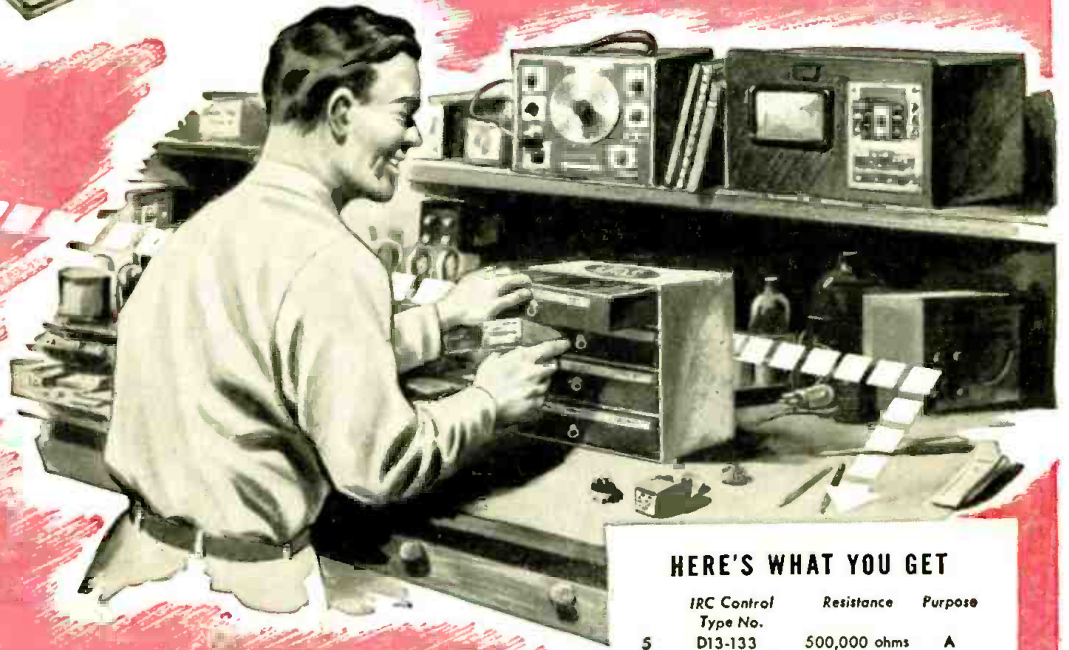

Here's one selection of 9 "hot-number" controls, switches and shafts you'll use every day! The new IRC Junior Control Cabinet contains 9 of the most-used 1/2, 1 and 2 meg. type D controls with the added adaptability of the tap-in shaft feature—plus 4 switches and 4 special shafts.

This inexpensive assortment of popular controls will save you time and money, and reduce your need for exact replacements. Factory-packed in a handsome four drawer cabinet of sturdy cardboard. Cabinet attractively finished in blue, yellow and silver with twelve individually identified compartments. Order the new inexpensive JUNIOR Control Cabinet from your IRC Distributor today. International Resistance Company, 401 N. Broad Street, Philadelphia 8, Pennsylvania. In Canada: International Resistance Company, Ltd., Toronto, Licensee.

HERE'S WHAT YOU GET

	IRC Control Type No.	Resistance	Purpose
5	D13-133	500,000 ohms	A
1	D13-133X	500,000 ohms	B
1	D13-137	1.0 meg.	A
1	D13-137X	1.0 meg.	B
1	D13-139	2.0 meg.	A

Purpose: A-Tone or Audio Circuit control;
B-Tapped for tone compensation.

SWITCHES

3	#41	S.P.S.T.
1	#42	D.P.S.T.

SHAFTS

1 Type "A" double-flatted tap-in shaft is included with each control—plus:

3 Type "E" with universal knurl for special type push on knobs.

1 Type "H" with universal groove for many Delco, RCA, Sears-Roebuck and Westinghouse models.

INTERNATIONAL RESISTANCE COMPANY



Wherever the Circuit says 